

# IMD

# PHASE

# SINAD



PORTABLE ONE PLUS ACCESS  
 PORTABLE ONE DUAL DOMAIN  
 GPIB PROGRAMMER'S REFERENCE MANUAL

DAMplitude:MMIN?

Returns the current upper magnitude range setting for the speed and graph displays in currently selected units.

Related Commands: DAMplitude:MMIN

Syntax: DAMplitude:MMIN?

Example: DAMPLITUDE:MMIN?

Response: MMIN -120 DBFS;

DAMplitude:SET?

Returns the current upper magnitude range setting for the speed and graph displays in currently selected units. The response is a list of parameters and values. The response is a list of parameters and values. The response is a list of parameters and values.

Response: MMIN -120 DBFS; DAMplitude:SET?

Syntax: DAMplitude:SET?

Example: DAMPLITUDE:SET?

Response: :DISP GPIB; :DAMPL:AMAX 0.

DBV; AMIN -999. DBV; BPFR 1.E+3 HZ; EXTERNAL GLIDE; FILTER UNWTD; FMAX 20.E+3 HZ; FMIN 20. HZ; HPASS HP10; LPASS HALFRATE; MMAX 0. DBFS; MMIN -120. DBFS; SPEED FAST; STEPS 0; SWPTYPE FREQ; UNIT DBFS; WTD IECA; :DISP

# Portable One Plus Access and Dual Domain GPIB Programmers Reference Manual



---

Copyright © 1998 by Audio Precision, Inc. All rights reserved. No part of this document may be reproduced or transmitted in any form or by any means, electronic or mechanical, including photocopying, recording, or by any information storage and retrieval system, without permission in writing from the publisher.

Audio Precision®, System One®, System One + DSP®, System Two™, FASTTEST®, APWIN™, Portable One®, and Dual Domain® are trademarks or registered trademarks of Audio Precision, Inc.

Published by:

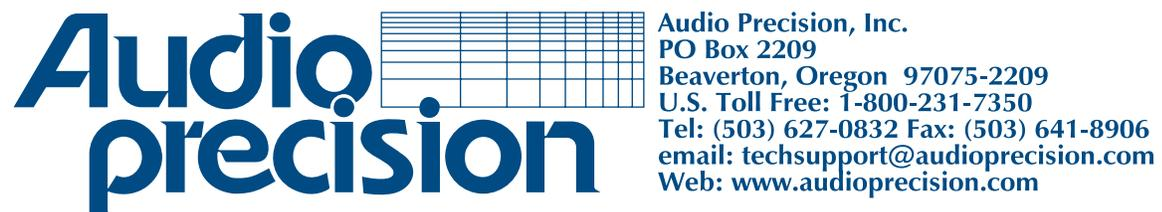

Printed in the United States of America

# Contents

<b>1. General Information .....</b>	<b>1-1</b>
Scope of This Manual .....	1-1
Overview of the Instrument.....	1-1
Analog Audio Functions .....	1-1
Digital Audio Functions (Dual Domain).....	1-1
Digital Interface Functions (Dual Domain).....	1-2
Establishing GPIB Communication.....	1-2
GPIB Connection .....	1-2
GPIB Address and Mode .....	1-3
Command Notation, Structure, and Syntax.....	1-4
Abbreviations and Case.....	1-4
Syntax Notation .....	1-4
Syntactic Delimiters .....	1-5
Program Messages.....	1-5
Program Message Units .....	1-5
Message Unit Syntax .....	1-5
Compound Command Headers .....	1-6
Query Response Headers .....	1-6
Delayed Query Responses.....	1-6
Input / Output Deadlocks.....	1-6
Verbose and Terse Query Responses.....	1-6
Concatenating Message Units .....	1-7
Common Commands.....	1-7
Command Arguments .....	1-7
Mnemonic .....	1-8
Decimal Numeric.....	1-8
Units and Numeric Suffixes.....	1-8
IEEE-488.1 Interface Functions.....	1-9
Determining Instrument Status.....	1-9
Status Registers.....	1-10
The Standard Event Status Register (SESR) & *ESR? .....	1-10
The Status Byte Register (SBR) & *STB? .....	1-11
Enable Registers .....	1-11
The Event Status Enable Register (ESER).....	1-12
The Service Request Enable Register (SRER) .....	1-12
Event Handling Sequence .....	1-12
Error Codes and Error Messages.....	1-14
Synchronization Methods .....	1-15
Using the *OPC Command.....	1-15
Serial Poll Method .....	1-15
Service Request Method .....	1-15
Using the *OPC? Query .....	1-16
Using the SBR MAV Bit To Acquire Query Responses.....	1-16
Making Measurements .....	1-16
Measurement Acquisition .....	1-18
Settled Measurements.....	1-18
Settling Parameters.....	1-18

Triggered Measurements .....	1-19
Measurement Functions Change Generator Settings .....	1-20
Summary.....	1-20
Detailed Description .....	1-20
Sweeps.....	1-23
Frequency Sweeps.....	1-23
Amplitude Sweeps.....	1-23
Improved Performance with the DISPLAY GPIB Command .....	1-25
Command Groups.....	1-26
System Commands (Section 2) .....	1-26
Measurement Commands (Section 3).....	1-26
Analog Generator Commands (Section 4).....	1-26
Analog Analyzer Commands (Section 5) .....	1-27
Dual Domain - Digital Generator Commands (Section 6).....	1-27
Dual Domain - Digital Analyzer Commands (Section 7) .....	1-27
Dual Domain - Digital Output Status Commands (Section 8) .....	1-27
Dual Domain - Digital Input Status and Error Commands (Section 9) .....	1-28
Analyzer Function-Setting Commands.....	1-28
Power-On Settings.....	1-29
Factory Default Settings.....	1-29
Reset Settings .....	1-29
GPIB Sample Program .....	1-30
GPIB Sample Program Listing.....	1-31
Settings Recall Sample Program .....	1-37
Settings Recall Sample Program Listing.....	1-38
Settings Save Sample Program.....	1-43
Settings Save Sample Program Listing.....	1-44
<b>2. System Command Descriptions .....</b>	<b>2-1</b>
<b>3. Measurement Command Descriptions .....</b>	<b>3-1</b>
<b>4. Analog Generator Command Descriptions.....</b>	<b>4-1</b>
<b>5. Analog Analyzer Command Descriptions.....</b>	<b>5-1</b>
<b>6. Digital Generator Command Descriptions.....</b>	<b>6-1</b>
<b>7. Digital Analyzer Command Descriptions .....</b>	<b>7-1</b>
<b>8. Digital Output Status Command Descriptions.....</b>	<b>8-1</b>
<b>9. Digital Input Status Command Descriptions .....</b>	<b>9-1</b>
<b>Appendix A – ASCII Code Chart and IEEE-488 Codes .....</b>	<b>A-1</b>
<b>Appendix B – Factory Default Power-On Settings .....</b>	<b>B-1</b>
System Commands.....	B-1
Measurement Commands.....	B-1
Analog Generator Commands.....	B-1
Analog Analyzer Commands .....	B-1
Digital Generator Commands ( <i>P1DD</i> ) .....	B-3
Digital Analyzer Commands ( <i>P1DD</i> ).....	B-4
Digital Output Status Commands ( <i>P1DD</i> ).....	B-6
<b>Index .....</b>	<b>Index-1</b>

# 1. General Information

## Scope of This Manual

This GPIB Programmer's Reference Manual for the Portable One Plus Access (P1PA) and Portable One Dual Domain (P1DD) instruments provides information on the following key topics:

- Establishing GPIB communications
- GPIB programming and command reference

Even though you may be familiar with GPIB programming concepts, we recommend that you first read the **Establishing GPIB Communications** portions of this manual, which provides programming examples for all key areas of establishing GPIB communications and control.

This manual does not provide a detailed description of instrument operation. Instead, only summary descriptions are provided to explain the function of the commands. Refer to the **Portable One Plus Access User's Manual** or **Portable One Dual Domain User's Manual** for detailed information on operation of the instrument.

## Overview of the Instrument

The Audio Precision Portable One Plus Access is a comprehensive two-channel analog test set that provides the analog audio test functions shown below. The Audio Precision Portable One Dual Domain provides the two-channel digital audio test functions shown below in addition to the analog audio test functions of the Portable One Plus Access.

### Analog Audio Functions

- AC level (two channels simultaneously, wideband)
- Amplitude (wideband, weighted, or selective)
- Noise (wideband, weighted, or selective)
- THD+N (total harmonic distortion plus noise)
- SINAD (ratio of {signal + noise + distortion} to {noise + distortion})
- Phase (inter-channel or input-to-output phase shift through a device)
- SMPTE/DIN intermodulation distortion (option)
- Real-time two-channel amplitude ratio (inter-channel balance or device gain/loss)
- Wow and flutter
- Real-time frequency-selective crosstalk
- AC mains check (voltage, frequency, and distortion of the ac power line)
- AC resistance at the input of the device connected to the generator output

### Digital Audio Functions (Dual Domain)

- Level (two channels simultaneously)
- Amplitude (wideband, weighted, or selective)
- Noise (wideband, weighted, or selective)
- THD+N (total harmonic distortion plus noise)
- Phase (inter-channel)
- SMPTE intermodulation distortion

- Real-time two-channel amplitude ratio (inter-channel balance or device gain/loss)
- Real-time frequency-selective crosstalk
- Output-to-Input Delay

## Digital Interface Functions (Dual Domain)

- Interface Status Bytes
- Interface Amplitude
- Interface Jitter
- Interface Rate
- Interface Bit Error Rate

For manual operation, up to three major measurements can be made simultaneously and displayed on the front-panel back-lighted LCD (liquid crystal display) panel. For programmable operation, up to four measurements can be made simultaneously.

## Establishing GPIB Communication

All front-panel operations of the instrument can be remotely programmed via the General Purpose Interface Bus (GPIB) connector on the rear panel. It is fully compatible with IEEE Std 488.1-1987, which specifies the hardware interface, its basic functional protocol, and a set of interface messages (codes) that control the instrument functions. This instrument also conforms to most parts of the IEEE Std 488.2-1987 that specifies codes, formats, protocols, and common commands.

### GPIB Connection

The instrument has a 24-pin GPIB-compatible connector on the rear panel. This D-shell connector conforms to the mechanical requirements of IEEE-488.1-1987. The instrument is connected to the instrument controller via a GPIB cable. The instrument controller— e.g., a personal computer— must have a corresponding GPIB interface port. The GPIB cables are designed so they can be stacked if needed to connect multiple instruments into your GPIB system.

When connecting instruments into a GPIB system, observe the following rules:

- Connect and disconnect instruments from the bus only when the power to all instruments in the system is off.
- Assign a unique GPIB address to each instrument (device) on the bus.
- Devices may be connected in a star or linear configuration, or a combination of star and linear configuration (see Figure 1-1).

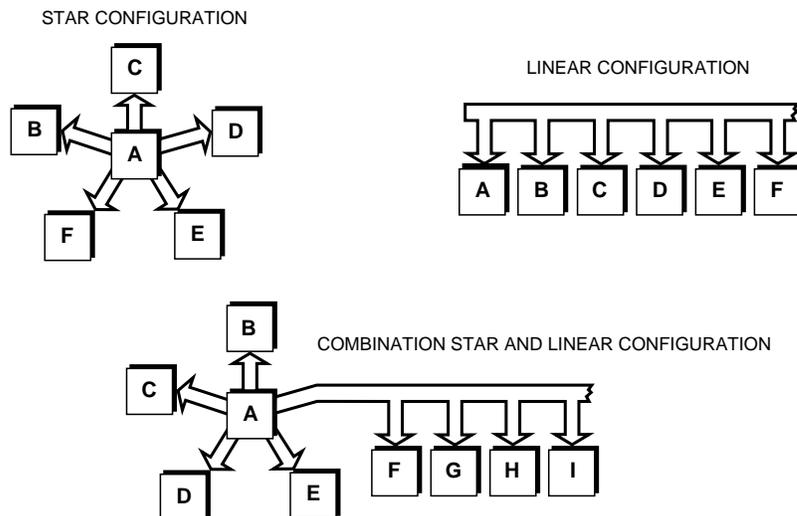

Figure 1-1. GPIB devices may be connected in star, linear, or combination star/linear configurations

- Do not attach more than 15 devices (including the controller) to the bus.
- One device must be attached to the bus for every four meters (13 feet) of cable.
- Total cable length must not exceed 20 meters (66 feet).
- At least two-thirds of the devices on the bus must be powered up for operation.

### GPIB Address and Mode

The instrument must be set to a unique GPIB address, one that is not shared by any other device on the bus. The GPIB address and mode must be set by the PANELS button located in the INSTRUMENT MODE section of the front panel (see Figure 1-2). Press the PANELS button until the GPIB setup display comes up (the display cycles to the next of the four instrument modes each time it is pressed).

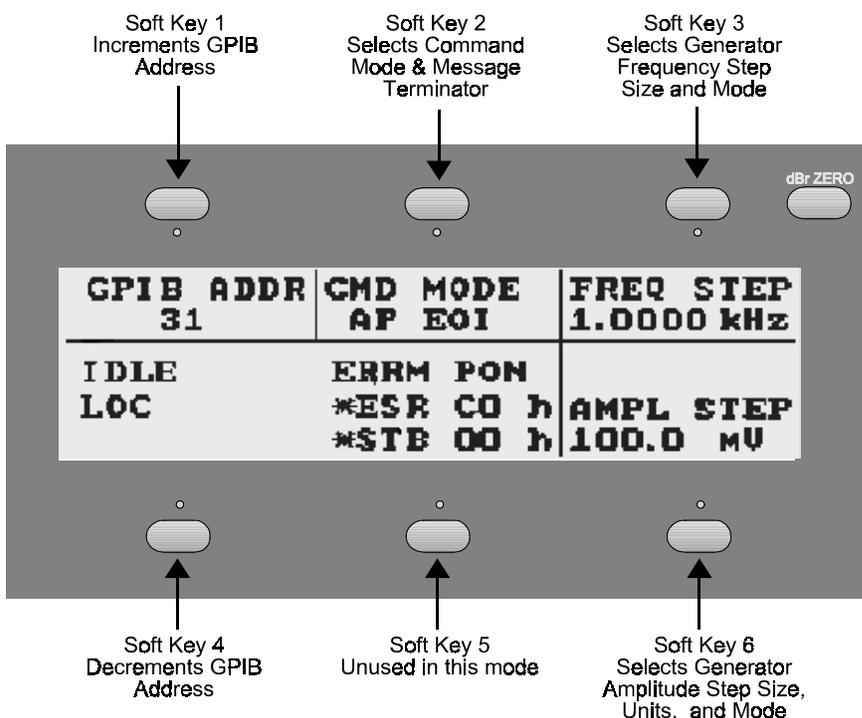

Figure 1-2. Location of soft keys for setting GPIB address and message terminator.

When the GPIB setup display is active, the soft keys function as shown in Figure 1-2.

SOFT KEY 1	Increments GPIB address from 0 to 31.
SOFT KEY 2	Selects message terminator:
EOI:	Selects EOI message terminator asserted with last byte (standard IEEE 488.2 mode).
CR LF:	Selects carriage return (CR) and line feed (LF) message terminators (for controllers that do not send EOI with the last byte).
SOFT KEY 3	Selects the generator frequency step size and mode (refer to the User's Manual for details).
SOFT KEY 4	Decrements GPIB address.
SOFT KEY 5	Unused in this mode.
SOFT KEY 6	Selects the generator amplitude step size, units, and mode (refer to the User's Manual for details).

Set the GPIB address as follows:

1. Press soft key 1 or 4 to select a unique GPIB address for this instrument. Any address from 1 to 31 can be selected (GPIB address 31 puts the instrument off line so it does not handshake on the bus).

*NOTE: To power up the instrument with the factory default settings, turn it on while pressing the **dBr ZERO** button. This sets the instrument to AP EOI mode and the GPIB address to 31, putting the instrument off line. See Appendix B for details on power-up defaults.*

2. Press soft key 2 to select the CMD MODE message terminator ("AP EOI" or "CR LF").

## Command Notation, Structure, and Syntax

The AP Mode command set conforms to the IEEE-488.2 specification. Commands are sent using ASCII character encoding. Commands are formed with characters described by the American Standard Code for Information Interchange (ASCII) character encoding. Appendix A shows the ASCII code chart.

### Abbreviations and Case

Any command that is sent to the instrument can be abbreviated. In this manual, upper case letters show the short form of the commands; any part of a command shown in lower case can be omitted. For example, the following set commands are synonymous:

```
FUNCTION AMPLITUDE
FUNC AMPL
FUNCTI AMPLIT
```

Commands can be formed in either upper or lower case. The instrument always responds to queries with upper case characters.

### Syntax Notation

The following symbols and meanings are used in this manual to describe the syntax of instrument AP Mode commands:

< >	Defined element
	Exclusive OR
{ }	Group, where one element is required
[ ]	Optional, can be omitted
...	Previous element or elements may be repeated

## Syntactic Delimiters

Syntactic elements in a program message are delimited (differentiated) with colons, white space, and semicolons.

Colon (:)	Delimits compound command headers. Functions with a colon delimiter have additional parameters. These functions are described in the order shown in the list in the Analog Analyzer section below.
White Space ( )	White space is used to delimit a command header from its argument. White space is defined as a single ASCII-encoded byte in the range ASCII 0 to 32 (decimal) with the exception of ASCII 10, the Line Feed (LF) character. The instrument ignores white space except as a syntactic delimiter (see <b>Compound Command Headers</b> , below).
Semicolon (;)	Delimits multiple message units.
Special Characters	The Line Feed (LF) character, also known as the New Line (NL) character, (ASCII 10) and all characters in the range of ASCII 127 to 255 are defined as special characters. These characters are used in binary sweep data query responses only; using these characters in set commands may yield unpredictable results.
Question Mark (?)	Distinguishes a query command (see <b>Program Message Units</b> , below).

## Program Messages

A program message is a sequence of program message units delimited by the semicolon (;) character. Control from a GPIB controller is accomplished by sending program messages to the instrument and receiving measurements and status messages from the instrument.

## Program Message Units

Program message units are **set commands** or **query commands** (usually referred to as **commands** and **queries**). Set commands are used to change instrument settings. Query commands cause the instrument to respond with measurements, instrument settings, or status information.

A **query command** is distinguished by a trailing question mark. Queries cause the instrument to return information about its status or settings.

For example, OUTPUT ON is the set command used to turn on the analog generator outputs. OUTPUT? is the query command used to interrogate the instrument for its analog generator output status.

Queries may consist of simple command headers or compound command headers with a trailing question mark (?) character:

Simple Header Syntax: [ : ]<Header>?

Compound Header Syntax: [ : ]<Header> : <Header>?

## Message Unit Syntax

A message unit is comprised of a header and an optional argument. Commands have the syntax:

[ : ]<Header> [ <white space> <Argument> ]

## Compound Command Headers

A message unit header may be a simple header or a compound header that contains multiple header mnemonics delimited with colons (:). Compound command headers are used for instrument function settings.

Syntax:

```
[:]<Header>:<Header>[<white space><Argument>][;]
```

An example of a compound command is shown below in which the number of amplitude function sweep steps is set to 30.

Example:

```
:AMPLITUDE:STEPS 30;
```

## Query Response Headers

You can control whether the instrument returns headers as part of the query response. Use the HEADER command to control this feature. With HEADER ON, the query response returns command headers and is formatted as a valid set command. With HEADER OFF, the response includes only the argument, without the header. Query responses without headers are often desired when the response is a measurement value that is easier to convert to a number when a header string is omitted from the response. Some of the IEEE-488.2 common commands are queries, which respond without headers as required by the specification and will not be affected by the HEADER command.

## Delayed Query Responses

All queries generate an immediate response when received with the exceptions below:

- Measurement queries with settling enabled (SETTLE ON).
- Measurement queries for non-triggered measurements in triggered mode (TRIGGER ON)
- \*OPC? responses waiting for an event to complete (sweeps and settled or triggered readings)
- Sweep measurement queries DATA1?, DATA2?, DATAF?, DATAA?

## Input / Output Deadlocks

The instrument has 5120 bytes (characters) of memory space for queuing set commands and queries in its input queue and has 5120 bytes of memory space for query responses in its output queue. Multiple queries will be processed in the order received until either the input queue is full or the output queue is full or both queues are full (resulting in an I/O deadlock).

An I/O deadlock can occur if the input queue becomes filled with multiple queries and the output queue is full of unread responses. If an I/O deadlock occurs then both the input queue and the output queue will be cleared and error 8 “GPIB Input and Output buffers have been cleared” will be generated. Error 8 sets the Device Dependent Error (bit 3) in the Standard Event Status Register.

## Verbose and Terse Query Responses

The VERBOSE ON command (default) specifies the standard long form of query response headers and arguments. The VERBOSE OFF command specifies terse forms of headers and arguments for query responses. These terse forms have the advantage of reducing the number of characters sent in response to queries and reducing the amount of time to complete the transmission but are more difficult to understand.

## Concatenating Message Units

Command messages may be constructed of multiple message units delimited from each other with the semicolon character (;). The instrument executes concatenated message units in the order received.

When concatenating message units into a complete command message, you should follow these rules:

1. Separate completely different headers by a semicolon and by the beginning colon on all commands but the first. For example, the commands OUTPUT and INPUT can be concatenated into a single command message:

```
OUTPUT ON;:INPUT A;
```

2. If concatenated message units have headers that differ by only the last mnemonic, you can abbreviate the second command and eliminate the beginning colon. For example, you can concatenate the commands AMPLITUDE:STEPS 30 and AMPLITUDE:FILTER WTD into a single command:

```
AMPLITUDE:STEPS 30;FILTER WTD
```

The longer version is also valid:

```
AMPLITUDE:STEPS 30;:AMPLITUDE:FILTER WTD
```

3. With concatenated queries, the responses to all the queries are concatenated into a single response message. For example, the concatenated query:

```
AMPLITUDE:STEPS?;:THD:STEPS?
```

will return the following if HEADER ON is in force:

```
STEPS 30;STEPS 0;
```

or the following if HEADER OFF is in force:

```
30; 0;
```

4. Commands and queries may be concatenated in the same command message. For example:

```
OUTPUT?;:AMPLITUDE:STEPS 10
```

is a valid message that queries the analog generator output state and sets the analog amplitude sweep step size to 30. Concatenated commands and queries are executed in the order received.

## Common Commands

Commands and queries that have an asterisk (\*) preceding the header are common commands. Common commands are defined by the IEEE-488.2 standard and are required by all devices that support the standard. The instrument implements all required common commands.

## Command Arguments

A command argument (sometimes called program data) is a quantity, quality, restriction, or limit associated with the command header. The argument is one of the following types depending upon the command header:

- Mnemonic
- Decimal Numeric

## Mnemonic

A mnemonic is an alphanumeric string that represents one of the possible argument values. A mnemonic always begins with an alpha character.

## Decimal Numeric

The instrument defines a decimal numeric argument expressed as NRf (Numeric Representation flexible). A NRf formatted number may be any of the formats shown below:

Format	Example
Implicit point	1, +3, -2, +10
explicit point unscaled	1, +2.8, -0.021, +98.65
explicit point scaled	1E+3, 9.8 E-3, +1.53E+2,-6.005E+3

## Units and Numeric Suffixes

Many instrument commands use decimal numeric arguments that allow optional units. For example, you can use 200m V instead of 200.0E-3 to specify analog generator output voltage. In this example, the “m” suffix is used with the V unit to specify millivolts.

Suffixes may be used to simplify the format of the number. You can use the suffix alone without the unit (using the default unit) or use the unit without the suffix. Valid units are indicated for each command later in this manual.

The suffixes that may be used are shown below. Note that upper and lower case suffixes are permissible.

Unit Prefix	K or k	M or m	U or u	N or n
Corresponding Power	$10^3$ kilo	$10^{-3}$ milli	$10^{-6}$ micro	$10^{-9}$ nano

## IEEE-488.1 Interface Functions

The instrument supports the IEEE-488.1 standard interface functions shown below.

**Table 1-1. IEEE-488.1 GPIB interface functions**

SH1	Source Handshake	complete capability
AH1	Acceptor Handshake	complete capability
T6	Talker	basic talker, untalk if listen address received, no talk only, serial poll capability (serial poll status byte defined by IEEE-488.2 standard for Status Byte Register) supports the UNL, UNT, SPD and SPE interface messages
TE0	Talker Extended	no capability, no secondary addressing
L4	Listener	basic listener, no listen only, unlisten if talk address received
LE0	Listener Extended	no capability, no secondary addressing
SR1	Service Request	complete capability, asserts SRQ interface line when service is required (if enabled by Service Request Enable Register)
RL1	Remote Local	complete capability, no front panel lockout in REMS (addressed with Remote Enable line true), full front panel lockout in RWLS (receipt of LLO interface message with Remote Enable line true) supports the GTL and LLO interface messages
PP0	Parallel Poll	no capability does not support the PPC, PPD, PPE, or PPU interface messages
DC1	Device Clear	complete capability, clear input and output queues, halt internal sweep and self-test supports the DCL and SDC interface messages
DT1	Device Trigger	complete capability, triggers measurements if the GET interface message is received with TRIGGER ON supports the GET interface message
C0	Controller	no capability does not support the TCT interface message
E2	Tri-State I/O Drivers	high impedance with power off

## Determining Instrument Status

The instrument provides a status and event reporting system for the GPIB interface. This system informs you of certain significant events that occur within the instrument. This section describes these registers and explains how the event handling system operates. The status handling system consists of four 8-bit registers. The registers in the event handling system fall into two functional groups:

- **Status Registers** contain information about the status of the instrument. They include the Standard Event status Register (SESR) and the Status Byte Register (SBR).
- **Enable Registers** determine whether selected types of events are reported to the Status Registers and the Event Queue. They include the Event Status Enable Register (ESER), and the Service Request Enable Register (SRER).

## Status Registers

The Standard Event Status Register (SESR) and the Status Byte Register (SBR) record certain types of events that may occur while the instrument is in use. IEEE Std 488.2-1987 defines these registers. Each bit in a Status Register records a particular type of event, such as an execution error or service request. When an event of a given type occurs, the instrument sets the bit that represents that type of event to a value of one. (You can disable bits so that they ignore events and remain at zero. See the **Enable Registers** section.) Reading the status registers tells you what types of events have occurred.

### The Standard Event Status Register (SESR) & \*ESR?

The SESR records eight types of events that can occur within the instrument. Use the \*ESR? query to read the SESR register. Reading the register clears the bits of the register so that the register can accumulate information about new events.

7	6	5	4	3	2	1	0
PON	URQ	CME	EXE	DDE	QYE	RQC	OPC

*The Standard Event Status Register (SESR).*

**Table 1-2. Standard Event Status Register (SESR) bit functions**

Bit	Function
7 (MSB)	<b>PON</b> (Power On). Shows that the instrument was powered on.
6	<b>URQ</b> (User Request). Shows that a front-panel button was pressed.
5	<b>CME</b> (Command Error). Shows that an error occurred while the instrument was parsing a command or query.
4	<b>EXE</b> (Execution Error). Shows that an error occurred while the instrument was executing a command or query.
3	<b>DDE</b> (Device Error). Shows that a device error occurred, such as a conflict in settings that cannot be resolved in hardware.
2	<b>QYE</b> (Query Error). Shows that either an attempt was made to read the Output Queue when no data was present or pending, or that data in the Output Queue was lost.
1	<b>RQC</b> (Request Control). Not used.
0 (LSB)	<b>OPC</b> (Operation Complete). Shows that the operation is complete. This bit is set when all pending operations complete preceding a *OPC command.

## The Status Byte Register (SBR) & \*STB?

The Status Byte Register (SBR) records whether output is available in the Output Queue, whether the instrument requests service, and whether the Standard Event Status Register (SESR) has recorded any events.

Use a Serial Poll or the \*STB? query to read the contents of the SBR. The bits in the SBR are set and cleared depending upon the contents of the Standard Event Status Register (SESR), the Event Status Enable Register (ESER), and the Output Queue. When you use a Serial Poll to obtain the SBR, bit 6 is the Request Service (RQS) bit, which indicates whether or not the instrument asserted the SRQ interface line on the GPIB. When you use the \*STB? query to obtain the SBR, bit 6 is the Master Summary Status (MSS) bit, which indicates that either or both of the Event Status Bit or the Message Available bit were set and enabled by the Service Request Enable Register (SRER). The SBR is cleared only by reading it with a Serial Poll. Reading the SBR with \*STB? does not clear it.

7	6	5	4	3	2	1	0
—	RQS	ESB	MAV	—	—	—	—
	MSS						

*The Status Byte Register (SBR).*

**Table 1-3. Status Byte Register (SBR) bit functions**

Bit	Decimal Value	Function
7		Not used.
6	<b>64</b>	<b>RQS</b> (Request Service), obtained from a serial poll. Shows that the instrument requests service from the GPIB controller. <b>MSS</b> (Master Summary Status), obtained from *STB? query. Summarizes the ESB and MAV bits in the SBR.
5	<b>32</b>	<b>ESB</b> (Event Status Bit). Shows that status is enabled and present in the SESR.
4	<b>16</b>	<b>MAV</b> (Message Available). Shows that output is available in the Output Queue.
3 - 0		Not used.

## Enable Registers

ESER and SRER allow you to select what events are reported to the Status Registers. Each Enable Register acts as a filter to a Status Register and can prevent information from being recorded in the register.

Each bit in an Enable Register corresponds to a bit in the Status Register it controls. In order for an event to be reported to its bit in the Status Register, the corresponding bit in the Enable Register must be set to one. If the bit in the Enable Register is set to zero, the event is not recorded.

Various commands set the bits in the Enable Registers. The Enable Registers and the commands used to set them are described below.

## The Event Status Enable Register (ESER)

This register controls what types of events the Event Status Bit (ESB) in the SBR summarizes. Use the \*ESE command to set the bits in the ESER. Use the \*ESE? query to read it.

7	6	5	4	3	2	1	0
PON	URQ	CME	EXE	DDE	QYE	RQC	OPC

*The Event Status Enable Register (ESER).*

## The Service Request Enable Register (SRER)

This register controls which bits in the SBR generate a Service Request and are summarized by the Master Status Summary Status (MSS) bit. The Event Status Bit (ESB) and the Message Available bit (MAV) enable the corresponding bit in the SBR to generate a Service Request interrupt.

Use the \*SRE command to set the SRER. Use the \*SRE? query to read it. The RQS bit remains set to one until either the Status Byte Register is read with a Serial Poll or the MSS bit changes back to a zero.

7	6	5	4	3	2	1	0
—	—	ESB	MAV	—	—	—	—

*The Service Request Enable Register (SRER).*

## Event Handling Sequence

Figure 1-3 shows how to use the status and event handling system. In the explanation that follows, numbers in parentheses refer to the number notations in the figure.

When an event occurs, a signal is sent to the SESR (1).

If that type of event is enabled (that is, if the bit for that event is set to one) in the ESER (2) and the appropriate bit in the SESR is set to one, then the ESB bit (3) is set to one.

While the Output Queue is not empty (one or more bytes are available for output), the MAV bit (4) in the SBR is set to one.

When a bit in the SBR is set to one and the corresponding bit in the SRER (5) is enabled, the MSS bit (6) in the SBR is set to one and a service request is generated.

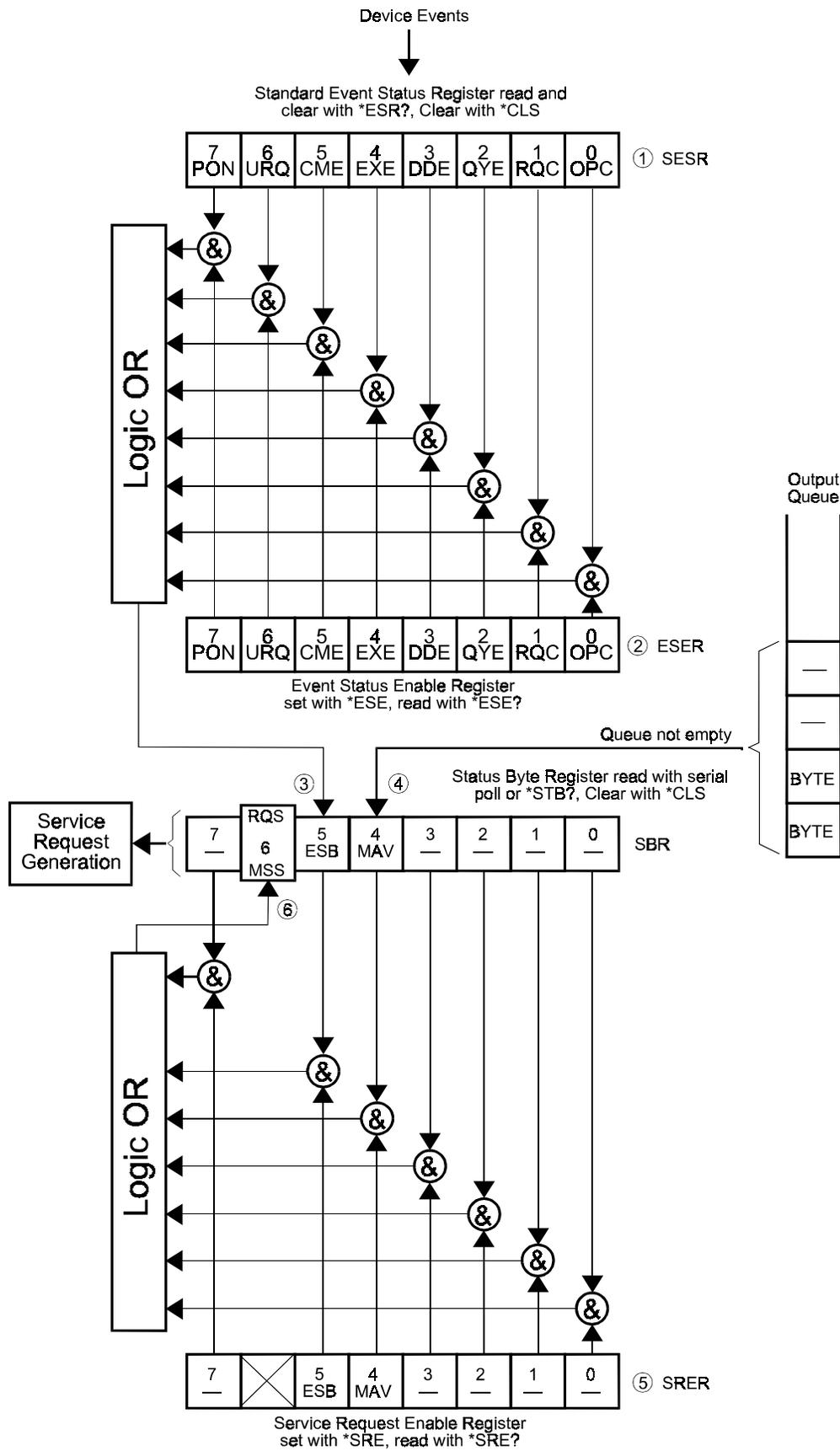

Figure 1-3. Status and Event handling process

## Error Codes and Error Messages

Programming error status may be reported through two methods. The first method uses the Standard Event Status Register, which can be read by the \*ESR? query. A particular class of errors or events, defined below, sets each bit. Bit 1 is not set by the instrument and is always 0. Multiple errors can be determined by evaluating the number returned in response to the \*ESR? query. Table 1-4 describes the meaning of the bits in the \*ESR? response.

**Table 1-4. Standard Event Status Register error codes**

Bit	7	6	5	4	3	2	1	0
Event	Power On	User Request	Command Error	Execution Error	Device Dependent Error	Query Error	Not Used	Operation Complete
Decimal Value	128	64	32	16	8	4	2	1

The second method provides a response to the ERRMESSAGE? query which reports a numeric value and a quoted string explaining the error. Since several conditions may be associated with a given bit in the Standard Event Status Register, the ERRMESSAGE? query provides more descriptive information about the error.

Table 1-5 lists the possible responses to the ERRMESSAGE? query and the bit in the Standard Event Status Register which is associated with each error message.

**Table 1-5. Error Messages**

Error Number	Error Message Response to ERRMESSAGE?	SESR Decimal Value	SESR BIT
0	None	0	NA
1	Invalid command header	32	5
2	Invalid command argument	32	5
3	Conflict with minimum amplitude	16	4
4	Conflict with maximum amplitude	16	4
5	Conflict with minimum frequency	16	4
6	Conflict with maximum frequency	16	4
7	Unknown argument list	32	5
8	Missing argument	32	5
9	Settling timeout	8	3
10	Some data in GPIB output buffer has been lost	4	2
11	Operation complete	1	0
12	No output available when addressed to talk	4	2
13	Power on	128	7
14	Command error	32	5
15	Sweep is using settling	32	5
16	Invalid unit	32	5
17	Measurement out of range	8	3
18	Argument out of range	16	4
19	Square wave conflict with Gen Ampl or Freq	8	3
20	GPIB input and output buffers have been cleared	8	3
21	User request – return to local	64	6
22	Input overrange	8	3
23	Empty or Deleted RCL/SAV Register	16	4
24	Protected RCL/SAV Register	16	4

## Synchronization Methods

Although most GPIB commands are completed almost immediately after being received by the instrument, some commands start a process that requires more time. For example, once a SWEEP START command is executed, it will be several seconds before the sweep operation is complete. Rather than remain idle while a sweep is in process, the system controller may perform other operations while waiting for an interrupt from the instrument. The instrument status reporting system provides ways to do this.

### Using the \*OPC Command

If the corresponding status registers are enabled, the \*OPC command sets the OPC bit in the Standard Event Status Register (SESR) when an operation is complete. You achieve synchronization by using this command with either a serial poll or service request handler.

### Serial Poll Method

Enable the OPC bit in the Event Status Enable Register (ESER) using the \*ESE command. When the operation is complete, the OPC bit in the Standard Event Status Register (SESR) and the Event Status Bit (ESB) in the Status Byte Register will be set.

The command sequence using the \*OPC command for synchronization with serial polling looks like this:

```
/* Set up an amplitude sweep */
FUNC AMPL
/* Enable the status registers */
*ESE 1;*SRE 0
/* Acquire sweep data */
SWEEP START
/* Wait until the sweep is complete before acquiring sweep data */
*OPC

/* while serial poll status byte = 0, keep looping */

/* Clear ESB bit */
*CLS
/* Read sweep data */
DATA1?;DATAF?
```

### Service Request Method

Enable the OPC bit in the Event Status Enable Register (ESER) using the \*ESE command. Also enable service requests by setting the ESB bit in the Service Request Enable Register (SRER) using the \*SRE command. When the operation is complete, a Service Request will be generated.

The same command sequence using the \*OPC command for synchronization looks like this. This technique is more efficient but requires more sophisticated programming.

```
/* Set up an amplitude sweep */
FUNC AMPL
/* Enable the status registers */
*ESE 1;*SRE 32
/* Acquire sweep data */
SWEEP START
/* Wait until the sweep is complete before acquiring sweep data */
*OPC

/* The program can now do different tasks such as talk to other devices.
When the SRQ comes, it interrupts those tasks and returns control to this
task. */

/* Clear ESB bit */
*CLS
/* Read sweep data */
DATA1?;DATAF?
```

## Using the \*OPC? Query

The \*OPC? query places a 1 in the Output Queue once an operation is complete. A time-out could occur if you try to read the Output Queue before there is any data in it.

The same command sequence using the \*OPC? query for synchronization looks like this. This is the simplest approach. It requires no status handling or loops. However, you must set the controller time-out for longer than the acquisition operation.

```
/* Set up an amplitude sweep */
FUNC AMPL
/* Acquire sweep data */
SWEEP START
/* Wait until the acquisition is complete before taking the measurement */
*OPC?

/* Wait for read from instrument Output Queue */

/* Read sweep data */
DATA1?;DATAF?
```

## Using the SBR MAV Bit To Acquire Query Responses

The MAV bit (Message Available) in the Status Byte Register may also be used to generate a service request interrupt when a query response is available in the instrument output queue. Settled readings and measurement sweep data may be acquired as they become available to permit the system controller to perform other tasks while waiting for an interrupt from the instrument.

The command sequence for acquiring new settled readings after a MAV interrupt looks like this:

```
/* Set up a triggered settled reading */
TRIGGER ON; FUNC AMPL; SETTLE ON;
/* Enable the status registers */
*SRE 16
/* Trigger and query for a reading */
M1?; *TRG

/* The program can now do different tasks. When the SRQ from the instrument
comes, it interrupts those tasks and returns control to this task. */

/* Read M1 response from instrument Output Queue */
```

## Making Measurements

The instrument provides up to four possible measurement values depending on the selected measurement function. The measurement values are provided in response to four specific queries that are related to the displayed measurements on the instrument front panel display. The displayed measurements are dependent on the measurement function selected with the FUNCTION command. Table 1-6 shows the relationship between selected measurement function and the values returned by each measurement query.

**Table 1-6. Measurement functions and measurement queries**

<b>Analog Functions</b>					
<b>Function</b>	<b>M1?</b>	<b>M2?</b>	<b>M3?</b>	<b>MF?</b>	<b>MP?</b>
AC Mains	AC Level	THD+N	Frequency	Frequency	NA
Amplitude	Band-limited Level	NA	Frequency	Frequency	NA
Noise	Band-limited Level	NA	NA	Frequency	NA
Genload	Resistance	NA	Frequency	Frequency	NA
IMD	Inter-modulation Distortion	Wide-band RMS Level	NA	Frequency	NA
Level	Wide-band RMS Level	Wide-band RMS Level	Frequency	Frequency	Phase
Phase	Phase	Wide-band RMS Level	Frequency	Frequency	Phase
Ratio	Ratio	Wide-band RMS Level	Frequency	Frequency	Phase
SINAD	Distortion	Wide-band RMS Level	NA	Frequency	NA
THD+N	Distortion	Wide-band RMS Level	NA	Frequency	NA
W+F	Wow & Flutter	Wide-band RMS Level	Frequency	Frequency	NA
XTALK	Crosstalk	Wide-band RMS Level	Frequency	Frequency	NA
<b>Dual Domain Digital Functions</b>					
<b>Function</b>	<b>M1?</b>	<b>M2?</b>	<b>M3?</b>	<b>MF?</b>	<b>MP?</b>
Amplitude	Band-limited Level	NA	Frequency	Frequency	NA
Noise	Band-limited Level	NA	NA	Frequency	NA
THD+N	Total Harmonic Distortion + Noise	Wide-band RMS Level	Frequency	Frequency	NA
IMD	Inter Modulation Distortion	Wide-band RMS Level	NA	Frequency	NA
Jitter	Jitter	Digital Interface Pulse Amplitude	Jitter Frequency	Jitter Frequency	NA
Digital I/O	Sample Rate	Digital Interface Pulse Amplitude	Digital Interface Delay	NA	NA
Level	Wide-band RMS Level	Wide-band RMS Level	Frequency	Frequency	Phase
Phase	Phase	Wide-band RMS Level	Frequency	Frequency	Phase
Ratio	Ratio	Wide-band RMS Level	Frequency	Frequency	Phase
XTALK	Crosstalk	Wide-band RMS Level	Frequency	Frequency	NA
Data Check	Bit Error	Bit Error	Data	NA	NA

## Measurement Acquisition

Measurements may be acquired from five measurement meters:

- The main function meter M1
- The secondary meter M2
- The tertiary meter for digital domain measurements M3
- The phase meter MP
- The frequency meter MF

Invalid measurements are reported with the invalid reading number,  $-1.E+30$ , indicating that a reading was requested which could not be measured or the instrument was in a state which cannot return the requested reading. Invalid measurements also cause Error 17 to be generated.

The analog phase meter provides valid measurements only if the LEVEL, RATIO, or PHASE measurements are currently selected. The digital phase meter provides valid measurements only if the DLEVEL, DRATIO, or DPHASE measurements are selected. The analog and digital phase meters will return the invalid reading number if any other functions are selected when a phase reading is requested.

The frequency meter returns the invalid reading number,  $-1.E+30$ , if the input level is too low for a valid reading.

## Settled Measurements

A settling algorithm is available for M1, the main function meter. The three other meters provide non-settled readings.

In the analog LEVEL and the digital DLEVEL measurement functions, the M2 meter reading is settled simultaneously with the M1 meter reading.

Responses to measurement queries consist of headers and arguments. The headers indicate the meter and the settled state of the reading argument. Arguments contain the measurement value and the currently selected units. The third character of the measurement header indicates whether the measurement was settled (S), unsettled (U), or no settling enabled (N). Unsettled indicates that the measurement was the average of readings in the settling buffer and that a settling time-out occurred. Settled indicates that the measurement was the most recent measurement in the settling buffer which met the settling criteria.

For example, M1? asks for a measurement from the main meter. The response could have three forms: :M1S 1.234 DBV; or :M1U 1.234 V; or :M1N 1.234 V;

## Settling Parameters

The settling algorithm takes readings until the settling parameters have been fulfilled or until a time-out value has been exceeded. The parameters are resolution (SRESolution), tolerance (STOLerance), number of points (SPOints), delay (SDElay), and time-out (STIMEout).

- SRESolution sets a lower resolution boundary, below which readings whose difference is less than this value will be considered settled.
- SPOints specifies the number of readings to be used for settling calculations, either two or three readings.
- STOLerance is the percent of change between readings which will be used as a criteria for settling.

- `SDELaY` is a delay in seconds to wait before starting to look for settled readings and is used after the generator frequency has been changed, typically when frequency sweeps are being performed.

The settling algorithm starts by waiting the time specified by `SDELaY`, starting a time-out timer, and taking the first reading. The timeout timer is checked after each reading. If a timeout has occurred, then the average of the last two or three readings (depending on `SPOints`) is returned as an unsettled reading.

If `SPOints` is two, a second reading is acquired and is considered settled if the difference between the readings is less than the resolution or is less than the tolerance times the most recent reading. If settled, the second reading is returned as the settled reading. If the second reading is not settled, a new reading is acquired and compared to the previous reading in like manner until either a settled reading or a timeout occurs.

If `SPOints` is three, a third reading is acquired and compared to `SRESolution` and to the second and first readings in similar fashion. If the third reading is settled with respect to both the first reading and the second reading, it is returned as the settled reading. If a time-out has not occurred and a settled reading has not been found, another reading is acquired and compared to the previous two readings. The process is repeated until either a settled reading is found or a timeout occurs.

## Triggered Measurements

Measurements may be initiated by the hardware in one of two modes, free run or triggered. The `TRIGGER OFF` command enables free-run measurements at the normal rate of up to eight readings per second. This is the normal mode of operation.

The `TRIGGER ON` command halts free-run measurement acquisition and places the instrument into a measurement mode that requires a trigger event to cause acquisition of readings. The `M1` reading in the display is not continually updated and thus does not show changes in the signal in real time. A trigger event is either receipt of the `*TRG` command or receipt of the Group Execute Trigger (GET) GPIB bus message. When a trigger event occurs the instrument makes one measurement cycle and then halts until triggered again by another trigger event. Receipt of a trigger event initiates one measurement cycle. A measurement cycle consists of one set of readings if settling is disabled or one settled reading if settling is enabled. Triggering affects all measurement meters.

The commands below illustrate the recommended method for setting up and triggering readings. The essential concept is that the trigger event must occur in order to get a reading that is synchronous with the trigger event. The command string `TRIGGER ON;M1?;*TRG` will setup the instrument for a triggered measurement, request the measurement data, and then trigger the measurement. The response would be a new measurement synchronous with the receipt of the `TRIGGER ON` command. An alternative to the `*TRG` is the GET message. The GET message is a convenient method of triggering multiple instruments on the GPIB bus to synchronize their actions.

A trigger event must occur in order to receive a response to the `M1?` command. The command string `TRIGGER ON;M1?` would fail to respond with a reading because no trigger event has occurred before the `M1?` query was sent. It will respond after a `GET`.

# Measurement Functions Change Generator Settings

## Summary

Selecting the analog function IMD sets the analog generator waveform to IMD.

Selecting the Digital function IMD sets the digital generator waveform to IMD.

Selecting the function Data sets the digital generator to RAND and turns the digital audio output off.

From any of the above functions, selecting another function sets the appropriate generator (digital or analog) waveform to SINE.

## Detailed Description

Analog measurement functions cause changes to the generator settings in order to setup for the selected measurement. The analog generator settings that are affected are the state of the output (OUTPUT) and the waveform (WAVEFORM). Table 1-7 and Table 1-8 show the effects of selecting analog and digital measurement functions.

Digital measurement functions in the Dual Domain instrument modify the digital generator settings in order to setup for the selected measurement. The digital generator settings that are affected are the state of the output (DOUTPUT) and the waveform (DWAVEFORM). For example, if the digital measurement function DNOISE is selected then the digital outputs will be switched OFF (muted). If the digital function DAMPLITUDE is selected next, then the digital outputs will be switched back ON (un-muted) to the previous state. Note that if the previous state was OFF then the outputs remain OFF.

The state of the digital output is also affected by the choice of waveform. Muting is automatic when the digital waveforms RANDOM, JTEST, or PASS are selected. Muting does not occur when the digital waveforms SINE, SQUARE, or IMD are selected. When a transition from a muted waveform to an un-muted waveform occurs, the instrument reverts to the last state of the un-muted waveform. For example, if the outputs are ON and the SINE waveform is selected, then the output will be OFF when the RANDOM waveform is selected. If the SQUARE waveform is then selected, the output will revert to the state that existed when the SINE waveform was selected. Note that if the previous state was OFF then the outputs remain OFF.

**Table 1-7. Analog measurement functions that alter analog generator settings**

<b>Analog Measurement Function</b>	<b>Analog Generator Setting</b>
AMPLITUDE FUNC AMPLITUDE	If the previous function was IMD then the analog generator SINE waveform will be selected
NOISE FUNC NOISE	The analog generator OUTPUT is turned OFF (muted) if previously ON. Selecting any other function after this change from OUTPUT ON to OFF will revert to the previous output state.
NOISE, DB UNITS FUNC NOISE; :NOISE:UNIT DB	The analog generator OUTPUT cycles OFF and ON.
THD+N FUNC THD	If the previous function was IMD then the analog generator SINE waveform will be selected.
SINAD, TUNE OFF FUNC SINAD; SINAD:TUNE OFF	Sets the analog generator to 400 Hz if TUNE OFF was the previous setup for SINAD. The analog generator frequency reverts to its prior setting if TUNE FIXTUNE or TUNE AUTO is selected or when any other function is selected.
IMD FUNC IMD	Selects the analog generator 2 tone IMD waveform.
Wow & Flutter FUNC WF	Sets analog generator frequency to 3150 HZ.
AC Mains FUNC ACMAINS	No change.
LEVEL FUNC LEVEL	If the previous function was IMD then the analog generator SINE waveform will be selected
PHASE FUNC PHASE	If the previous function was IMD then the analog generator SINE waveform will be selected
RATIO FUNC RATIO	If the previous function was IMD then the analog generator SINE waveform will be selected
XTALK FUNC XTALK	Turns ON the analog generator output channel (A or B) that is the opposite of the currently selected input channel to be measured (e.g. if INPUT A then OUTPUT B and vice versa).
GENLOAD FUNC GENLOAD	Sets the analog generator output A or B to the same state as the INPUT command (A or B).

**Table 1-8. Digital measurement functions that alter digital generator settings**

Digital Measurement Function	Digital Generator Setting
AMPLITUDE FUNC DAMPLITUDE	If previous function was DIMD or DCHK then selects digital generator SINE waveform. No change otherwise.
NOISE FUNC DNOISE	Sets DOUTPUT OFF if previously ON. Selecting any other function after this change from DOUTPUT ON to OFF will revert to the previous output state unless a different waveform is selected first.
THD FUNC DTHD	If the previous function was DIMD or DCHK then selects digital generator SINE waveform. No change otherwise.
IMD FUNC DIMD	Digital generator 2 tone DIMD waveform selected.
JITTER FUNC DJITTER	If the previous function was DIMD then selects digital generator SINE waveform. No change otherwise.
DIO FUNC DIO	If the previous function was DIMD then selects digital generator SINE waveform. No change otherwise.
LEVEL FUNC DLEVEL	If the previous function was DIMD or DCHK then selects digital generator SINE waveform. No change otherwise.
PHASE FUNC DPHASE	If the previous function was DIMD or DCHK then selects digital generator SINE waveform. No change otherwise.
RATIO FUNC DRATIO	If the previous function was DIMD or DCHK then selects digital generator SINE waveform. No change otherwise.
XTALK FUNC DXTALK	If the previous function was DIMD or DCHK then selects digital generator SINE waveform. Turns ON the digital generator output channel (A or B) that is the opposite of the currently selected input channel to be measured (e.g. if DINP A then DOUTPUT B and vice versa).
DATA CHECK FUNC DCHK	Selects the RANDOM digital generator waveform. Turns the digital generator outputs OFF.

## Sweeps

### Frequency Sweeps

Frequency sweeps involve setting the sweep type to frequency with the SWPTYPE command, e.g. **:AMPL:SWPTYPE FREQ**. Frequency sweeps involve sweeps of the frequency of the currently selected generator. For the Portable one Plus Access, only the analog generator is available for sweeps. For the Portable One Dual Domain, the GENERator command selects one of the three possible generators for display on the front panel and for use during a sweep. The range of frequencies is dependent on which generator is selected and which waveform it is generating. The maximum and minimum frequency sweep ranges are set by the FMAX and FMIN commands. The value for each command must be a number within the permissible range for the generator currently selected and its waveform currently selected. As a consequence of this linkage, the permissible values for FMAX and FMIN will change when the generator is changed. The instrument handles this by coercing the present values of FMAX and FMIN to correct values when the generator is changed or its waveform is changed.

As a general rule, the best practice for setting the maximum and minimum values for a frequency sweep is to set the generator and its waveform first, then set the FMAX and FMIN values with ranges compatible with the generator. For example, if it is desired to do a frequency response sweep of the analog generator sinewave at 0 dBV between 20 Hz and 30 kHz and measure the amplitude with the analyzer through a selective bandpass filter in dBV units, then send the following commands:

```
:GEN ANLG;WAVEFORM SINE;GAMPL 0 DBV;GFREQ 1000;OUTPUT ON;
:FUNC AMPL;SWPTYPE FREQ;FMAX 30000;FMIN 20;FILTER UNWTD;
UNIT DBV;;DISPLAY SWEEP;SWEEP START;DATAF?;DATA1?
```

The resultant response string is:

```
:DATAF
ASCII, HZ, 33, 20., 25., 31.5, 40., 50., 63., 80., 100., 125., 160., 200.
, 250., 315., 400., 500., 630., 800., 1.E+3, 1.25E+3, 1.6E+3, 2.E+3, 2.
5E+3, 3.15E+3, 4.E+3, 5.E+3, 6.3E+3, 8.E+3, 10.E+3, 12.5E+3, 16.E+3,
20.E+3, 25.E+3, 30.E+3;:DATA1 ASCII, DBV, 33, -0.01, -0.01, -0.02, -
0.02, -0.02, -0.02, -0.02, -0.02, -0.02, -0.02, -0.02, -0.02, -0.02, -
0.02, -0.02, -0.02, -0.02, -0.02, -0.02, -0.02, -0.02, -0.01, -0.01, -
0.01, -0.01, -0.02, -0.02, -0.02, -0.01, -0.01, -0.01, -0.01, -0.01;
```

### Amplitude Sweeps

Amplitude sweeps involve setting the sweep type to amplitude rather than frequency with the SWPTYPE command, e.g. **:AMPL:SWPTYPE AMPL**. Amplitude sweeps involve sweeps of the amplitude parameter of the generator. The Dual Domain GENERator command selects one of the three possible generators for display on the front panel and for use during a sweep. The range of amplitude values to sweep is dependent on the selected generator and upon the valid amplitude range for the selected type of waveform. The maximum and minimum amplitude sweep ranges are set by the AMAX and AMIN commands. The value for each command must be a number within the permissible range for the generator currently selected and its waveform currently selected. As a consequence of this linkage, the permissible values for AMAX and AMIN will change when the generator is changed. The instrument handles this by coercing the present values of AMAX and AMIN to correct values when a generator is changed or its waveform is changed.

**Table 1-9. Dual Domain Generator Types and Valid Units for AMAX and AMIN commands.**

Generator selected by the GENERator command.	AMAX and AMIN Valid Units	Default Unit
<b>ANLG</b>	<b>[VPK   V   DBV   DBU   DBM ]</b>	<b>V</b>
<b>DIG</b>	<b>[ DBFS   FFS ]</b>	<b>DBFS</b>
<b>JITT</b>	<b>[ UI   SEC ]</b>	<b>UI</b>
<b>RATE</b>	No Valid Units, RATE cannot be swept.	

**The correct unit argument for AMIN and AMAX also depends on the currently selected generator set by the GENERator command for the dual domain instrument. If an invalid unit is specified then the instrument will assume a valid default unit for the generator currently selected and coerce the numeric <nrf> argument to a value within the valid amplitude range for the currently selected generator. See**

Table 1-9 to determine the possible units and the default unit for each of the generators that may be selected with the GENERator command for the dual domain instrument.

As a general rule, the best practice for setting the maximum and minimum values for an amplitude sweep is to set the generator and its waveform first, then set the AMAX and AMIN values with units compatible with the generator. For example, if it is desired to do a gain linearity sweep of the analog generator sinewave at 1 kHz between -60 dBV and +10 dBV and measure the amplitude with the analyzer through a selective bandpass filter in dBV units, then send the following commands:

```
:GEN ANLG;WAVEFORM SINE;GAMPL 0 DBV;GFREQ 1000;OUTPUT
ON;:FUNC AMPL;SWPTYPE AMPL;AMAX 10 DBV;AMIN -60 DBV;FILTER
SEL;UNIT DBV;:DISPLAY SWEEP;SWEEP START;DATAA?;DATA1?
```

The resultant response string is:

```
:DATAA ASCII,DBV,37,-60.,-58.06,-55.92,-53.98,-52.04,-
50.03,-47.96,-46.02,-44.01,-41.94,-40.,-38.06,-35.92,-
33.98,-32.04,-30.03,-27.96,-26.02,-24.01,-21.94,-20.,-
18.06,-15.92,-13.98,-12.04,-10.03,-7.96,-6.02,-4.01,-1.94,
0., 1.94, 4.08, 6.02, 7.96, 9.97, 10.;

:DATA1 ASCII,DBV,37,-60.,-58.05,-55.93,-53.98,-52.05,-
50.05,-47.97,-46.03,-44.02,-41.94,-40.01,-38.07,-35.93,-
33.99,-32.05,-30.05,-27.97,-26.03,-24.02,-21.93,-19.99,-
18.06,-15.91,-13.98,-12.05,-10.04,-7.96,-6.02,-4.02,-1.94,
0., 1.93, 4.09, 6.02, 7.97, 9.98, 10.01;
```

## Improved Performance with the DISPLAY GPIB Command

Performance can be improved and total test time reduced by using certain programming techniques. The instrument accepts GPIB interface commands and displays the resultant state of the hardware on the front panel display. Performance can be improved by selecting a display that requires no updating when GPIB interface commands are sent to the instrument. Performance will be greatly enhanced if the front panel display is set to display the GPIB panel because the instrument will not update the front panel for each command it receives.

The \*LRN? response and the responses to the SET? commands take advantage of this feature by inserting a DISPLAY GPIB command at the beginning of the response and concatenating another DISPLAY command at the end of the response. This last DISPLAY command sets the instrument to the actual display setting in use when the query was received. This is done in order to generate a response string that can be used to re-program the instrument later. If the response string is used as a setting string, then the instrument will be momentarily set to display the GPIB panel until all settings have been received and processed. The last command displays the correct panel, resulting in an a setup exactly the same as the original. This practice speeds up the processing of GPIB interface commands by a factor of four.

The response to the :AMPLITUDE:SET? query is shown below to illustrate this point. In this example, the instrument first displays the GPIB display and then displays the PANEL display after all commands have been processed.

```
:DISP GPIB;:AMPLITUDE:AMAX 1. V;AMIN 0. V;BPFR 1.E+3  
HZ;EXTERNAL GLIDE;FILTER UNWTD;FMAX 20.E+3 HZ;FMIN 20.  
HZ;HPASS OFF;LPASS R300K;MMAX 10. V;MMIN 1.E-6 V;SPEED  
FAST;STEPS 0;SWPTYPE FREQ;UNIT V;WTD IECA;:DISPLAY PANEL;
```

## Command Groups

The instrument commands are Grouped as listed on the following two pages. Sections 2 through 9 of this guide describe the commands alphabetically in each group, including (when applicable):

- The full name, with the short form indicated by upper-case letters
- Summary of the function of each command
- Related commands to which you may want to refer
- Syntax statements
- Arguments
- One or more examples

### System Commands (Section 2)

System commands involve general communications, common system attributes (IEEE-488.2), instrument status, and front panel display mode. The commands with gray background are unique to the Dual Domain instrument.

*CLS	*SAV	DELay	LIGHt ...?
*ESE ...?	*SRE ...?	DELete ...?	NAME ...?
*ESR?	*STB?	DISPlay ...?	PRINT
*IDN?	*TRG	DTIMe ...?	PRN ...?
*LRN?	*TST?	DTRGout ...?	PROTect ...?
*OPC ...?	*WAI	ERRMessage?	SET?
*OPT?	CLROutbuf	GENerator ...?	TEST
*RCL	CLRTime	HEADer ...?	TIME?
*RST	DATE ...?	HELP?	VERBose ...?

### Measurement Commands (Section 3)

Measurement commands acquire measurement data, start measurement sweeps, set data formats, and control measurement triggering modes.

DATA1?	FUNcTION ...?	REPeat	STOLerance ...?
DATA2?	M1?	SDELay ...?	SWEep ...?
DATAA?	M2?	SETTle ...?	TRIGger ...?
DATAF?	M3?	SPOints ...?	
DBRZero	MF?	SRESolution ...?	
FORMat ...?	MP?	STIMeout ...?	

### Analog Generator Commands (Section 4)

Analog generator setup commands control output parameters of the analog generator. Some analog generator parameters are also changed by measurement functions (frequency, waveform type, and output on or off).

GAMPplitude ...?	GZ ...?	IMDLf ...?	WAVEform ...?
GFRequency ...?	IMDHf ...?	OUTPut ...?	

## Analog Analyzer Commands (Section 5)

Analog Analyzer setup commands control the types of measurements to be made and all parameters that affect them. The primary functions with colon delimiters shown below have additional parameters. Also see the *Analyzer Function Setting Commands* subsection.

HOLD	RNGB ...?	AMPLitude:	RATio:
INPut ...?	RNGM ...?	GENLoad:	SINad:
REFDBM ...?	ZINA ...?	IMD:	THD:
REFDBR ...?	ZINB ...?	LEVel:	WF:
REFWatt ...?		NOISE:	XTALK:
RNGA ...?	ACMains:	PHASe:	

## Dual Domain - Digital Generator Commands (Section 6)

Digital Generator setup commands control output parameters of the digital audio generator. Some generator parameters are also changed by measurement functions (frequency, waveform type, and output on or off).

DCAL ...?	DIMHf ...?	DOUTput ...?	JFRequency ...?
DGAMplitude ...?	DIMLf ...?	DSRef ...?	JWAVeform ...?
DGFRequency ...?	DITHer ...?	DSYNch ...?	
DGRate ...?	DOAMplitude ...?	DWAVeform ...?	
DGSQrfreq ...?	DOResolution ...?	JAMplitude ...?	

## Dual Domain - Digital Analyzer Commands (Section 7)

Digital Analyzer setup commands control the types of measurements to be made on digital audio inputs and all parameters that affect them. The primary functions with colon delimiters shown below have additional parameters. Digital Analyzer command parameters are given in Section 7. Also see the *Analyzer Function Setting Commands* subsection.

DAMplitude:	DIO:	DRATio:	DXTalk:
DCHK:	DJITter:	DREFdbr ...?	DZIN ...?
DHOLd ...?	DLEVel:	DRGA ...?	
DIMD:	DNOise	DRGB ...?	
DINPut ...?	DPHase:	DTHD:	

## Dual Domain - Digital Output Status Commands (Section 8)

Digital Output Status Commands control the digital status transmitted from the instrument to the receiving device. See Section 8 for Digital Output Status command descriptions.

DOSTatus:CONS ...?	DOSTatus:SET?	DOSTatus:VALidity ...?
DOSTatus:PROF ...?	DOSTatus:STDO ...?	

## Dual Domain - Digital Input Status and Error Commands (Section 9)

Digital Input Status and Error Commands decode status received by the instrument and detect error conditions at the digital input (Invalid, Confidence, Coding, Parity, and Lock). These commands are described in Section 9.

DISTatus:CODing?	DISTatus:PARity?	DISTatus:LOCK?
DISTatus:CONfidence?	DISTatus:STDI?	DISTatus:STATus?
DISTatus:INValid?	DISTatus:ERRor?	

## Analyzer Function-Setting Commands

All function-setting commands have parameters specific to each measurement function. They are retained in memory and become active when the function is selected with the FUNCtion command. Parameters for these functions can be changed without changing the active function. For example, if FUNC AMPL has been sent to make measurements with the analog analyzer AMPLITUDE function, then a change to the LEVEL function with a :LEVEL:UNIT V; command will not affect the UNIT command for the AMPLITUDE function. The changes to the LEVEL function are retained in memory and become active only when the FUNC LEVEL command is sent.

Each function setting below requires a compound command header to specify which function is being changed, since many of the parameters use the same name to simplify programming. According to the IEEE-488.2 standard, a compound command requires the colon prefix unless it is the first command in a message. Each compound header may be followed by multiple setting commands, each terminated with a semicolon. A new command or compound header may follow if it is prefixed with a colon.

### Example 1

Compound header at the beginning of a message.

```
ACMAINS:LUNIT PCT;UNIT V;
```

### Example 2

Compound header after another command.

```
OUTPUT ON;:ACMAINS:LUNIT PCT;UNIT V;
```

### Example 3

Commands before and after compound header commands.

```
OUTPUT ON;:ACMAINS:LUNIT PCT;UNIT V;:OUTPUT OFF;
OUTPUT ON;:ACMAINS:LUNIT PCT;UNIT V;:THD:LUNIT DBV;UNIT PCT;:OUTPUT OFF;
```

The instrument complies with the IEEE-488.2 standard but optionally allows the compound command header to not require a colon prefix. The following examples show the alternative syntax:

### Example 4

```
OUTPUT ON;ACMAINS:LUNIT PCT;UNIT V;
```

### Example 5

```
OUTPUT ON;ACMAINS:LUNIT PCT;OUTPUT OFF;
OUTPUT ON;ACMAINS:LUNIT PCT;THD:LUNIT DBV;OUTPUT OFF;
```

The instrument always responds to queries with colon delimiters prefixed to all headers.

## Power-On Settings

The current state of all controls and functions is remembered in non-volatile ram when the instrument power is turned off. When power is turned on the instrument retrieves these settings from the non-volatile memory to restore the instrument setup.

## Factory Default Settings

Press and hold the front panel **dBr ZERO** button while turning power on to restore the factory default settings. The GPIB address is set to address 31 (with EOI terminator) which puts the instrument off line, disabling it from participating in GPIB communications. Factory default settings are shown in Appendix B.

## Reset Settings

The \*RST (reset) command sets all instrument controls and functions to the factory power-on default settings. The command mode setting is not affected and the instrument GPIB address is not changed. Factory default settings are shown in Appendix B for each command.

# GPIB Sample Program

This sample program illustrates how to setup and use the Portable One Dual Domain to perform automated sweep measurements. The Visual Basic 5.0 program below resides in one module file P1ACDDGPIBSAMPLE.BAS. It requires a National Instruments GPIB interface card with a driver for Windows 95 and the two modules NIGLOBAL.BAS and VBIB-32.BAS, version 1.6 or later. This code and related files are on the sample program CD provided with this manual.

The program performs a free-run measurement acquisition and a triggered measurement acquisition of stereo level, channel A frequency, and inter-channel phase, followed by a sweep of THD+N distortion versus frequency on channel A, followed by a gain linearity sweep on channel A. The inputs are internally connected to the generator outputs using the generator monitor input configuration.

For each of the two measurements and for each sweep the program synchronizes GPIB reads of the output queue by testing the Event Status Bit in the status byte register. The Event Status Bit will be set when the OPC bit in the Event Status Register is set to a 1 after a measurement or sweep has finished.

The displays below illustrate the sequence of normal messages presented in VB Message Boxes while the program is running.

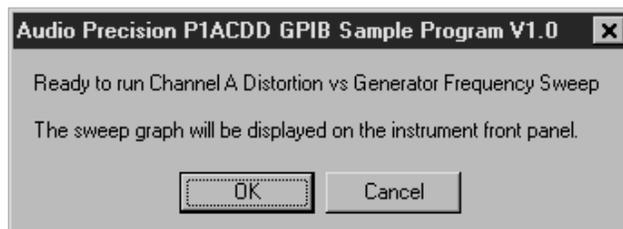
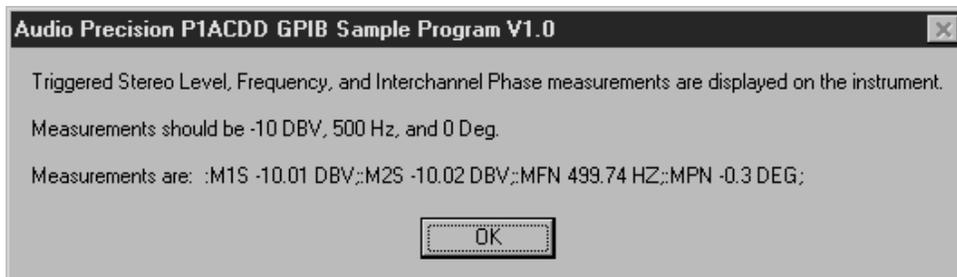
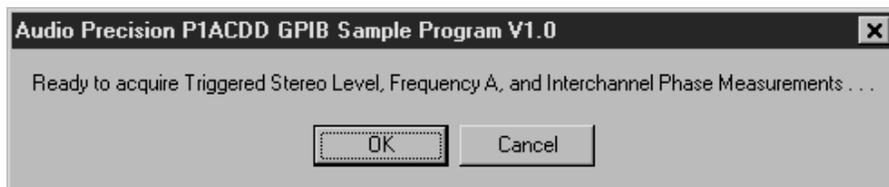
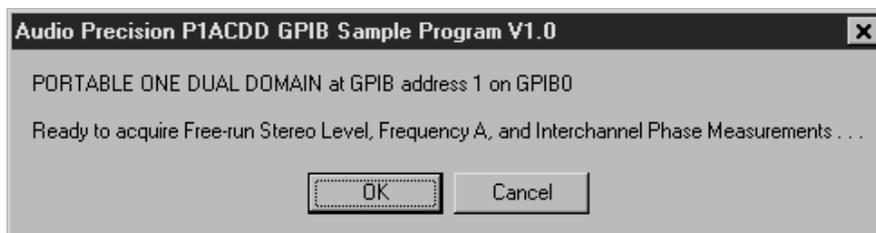

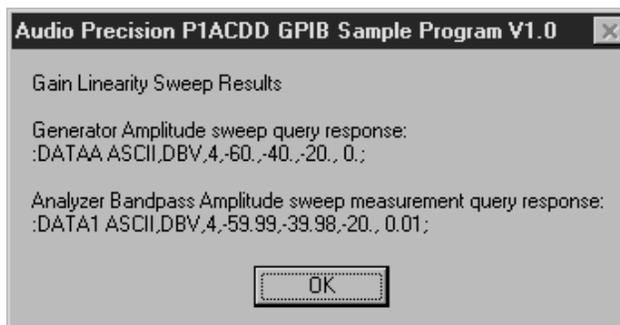
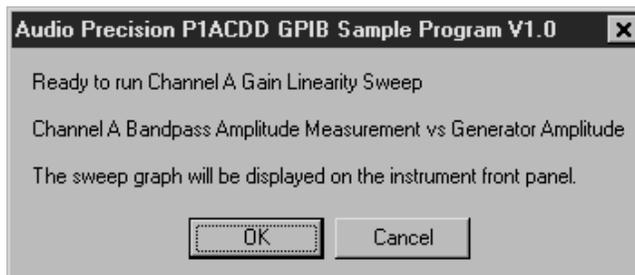
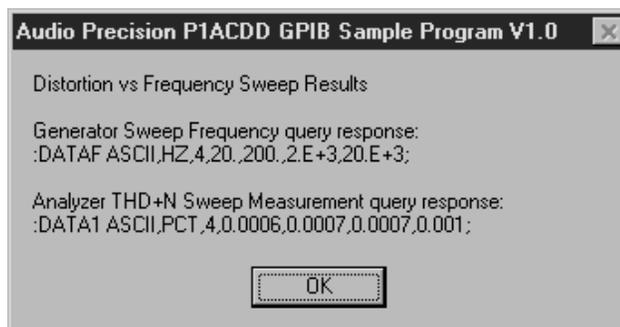

## GPIB Sample Program Listing

```
' P1ACDDGPIBSAMPLE.BAS
' Example GPIB program for Microsoft Visual Basic 5.0
' July 15,1998, Copyright (c) 1998 Audio Precision Inc.
' All Rights Reserved
' An example of instrument setup and OPC measurement synchronization,
' free-run measurements, triggered measurements, and sweeps of
' Analog Distortion vs Frequency and Gain Linearity using
' a National Instruments GPIB interface for Win95.
' This program supports Audio Precision models:
' ATS-1 Access, ATS-1 Dual Domain, Portable One Plus Access,
' and Portable One Dual Domain.
' Uses modules "Niglobal.bas" and "Vbib-32.bas" ver 1.6 for VB 5.0
' from National Instruments Corp.
Option Explicit
Public sBoard As String
' GPIB input buffer byte length, must be large enough to receive an
' instrument measurement query response. The size is dependent on
' the number of measurements selected for a sweep.
Const BUFLNGTH = 1000
' GPIB board number 0
' Change if your board is other (0, 1, 2, or 3)
Const BOARD = 0
Const MSGBOX_TITLE = "Audio Precision GPIB Sample Program V1.0"
Const ATS1A = "ATS-1"
Const ATS1DD = "ATS-1 DUAL DOMAIN"
Const P1PA = "PORTABLE ONE PLUS ACCESS"
Const P1DD = "PORTABLE ONE DUAL DOMAIN"
Const NOTFOUND = -1

' VB 5.0 Startup Object is Sub Main
```

```

Sub Main()
  Dim iAP As Integer, iSPR As Integer, iAddr As Integer
  Dim sData As String, sFreq As String, sMsg As String
  Dim iStatus As Integer, sID As String, sOPC As String
  sBoard = "GPIB" & Right(Str(BOARD), 1)
  sData = Space(BUFLLENGTH)
  sFreq = Space(BUFLLENGTH)
  ' Find the first GPIB listener connected to this GPIB interface
  ' board that is an ATS-1 Access, ATS-1 Dual Domain,
  ' Portable One Plus Access, or a Portable One Dual Domain.
  ' Return an instrument ID and GPIB address if found.
  iAP = FindAP(sID, iAddr)
  If iAP = NOTFOUND Then
    ' The GPIB search for the instrument failed. Exit the program.
    sMsg = "An " & ATS1A & " or " & ATS1DD & " or " & P1PA _
      & " or " & P1DD & " was not found on " & sBoard
    MsgBox sMsg, vbExclamation, MSGBOX_TITLE
  Else
    ' The GPIB search for the instrument was successful.
    ' Reset the instrument to default settings
    ' & enable ESER OPC status bit
    GpibWrite iAP, "*RST;*ESE 1;"
    sMsg = sID & " at GPIB address " & iAddr
    sMsg = sMsg & " on " & sBoard & vbCrLf & vbCrLf
    sMsg = sMsg & "Ready to acquire Free-run Stereo Level, "
    sMsg = sMsg & "Frequency A, and Interchannel Phase"
    sMsg = sMsg & " Measurements . . ."
    If MsgBox((sMsg), vbOKCancel, MSGBOX_TITLE) = vbOK Then
      ' Acquire free-run A & B stereo level, frequency A,
      ' and interchannel phase measurements.
      ' reporting in the Status Byte Register.
      GpibWrite iAP, "INPUT GAGB;OUTPUT ON;GAMPLITUDE 0.5 V;"
      GpibWrite iAP, "LIGHT ON;FUNCTION LEVEL;SETTLE ON;"
      GpibWrite iAP, ":LEVEL:UNIT V;DISPLAY PANEL"
      ' Query the level and frequency measurements.
      ' Set OPC bit when all queries have been processed.
      GpibWrite iAP, "*CLS;M1?;M2?;MF?;MP?;*OPC"
      ' Serial poll until the OPC bit is set (Operation Complete)
      ' in the Status Byte Register.
      Do
        ' Read the instrument status byte with a Serial Poll.
        iStatus = ilrsp(iAP, iSPR)
        ' Let other Windows tasks run too.
        DoEvents
      Loop While (iSPR And 32) <> 32 ' Check for the OPC bit set.
      ' Read the measurements.
      sData = GpibRead(iAP, BUFLLENGTH)
      GpibWrite iAP, "*CLS" ' Clear the status registers.
      ' sOPC = GpibRead(iAP, BUFLLENGTH)
      ' Display the measurements.
      sMsg = "Free-run Stereo Level, Frequency A, and "
      sMsg = sMsg & "Interchannel Phase Measurements "
      sMsg = sMsg & "are displayed on the instrument." & vbCrLf
      sMsg = sMsg & vbCrLf & "Measurements are: " & sData
      MsgBox sMsg, vbOKOnly, MSGBOX_TITLE
      ' Disable settled measurement mode.
      GpibWrite iAP, "SETTLE OFF"
    End If

    ' Acquire triggered stereo level, frequency,
    ' and interchannel phase measurements.
    sMsg = "Ready to acquire Triggered Stereo Level, Frequency A, "
    sMsg = sMsg & " and Interchannel Phase Measurements . . ."
    If MsgBox((sMsg), vbOKCancel, MSGBOX_TITLE) = vbOK Then
      ' Get a triggered measurement using GET message.
      GpibWrite iAP, "*CLS;INPUT GAGB;OUTPUT ON;GAMPLITUDE -10 DBV;"
      GpibWrite iAP, "GFREQUENCY 500 HZ;FUNCTION LEVEL;SETTLE ON;"
      GpibWrite iAP, ":LEVEL:UNIT DBV;DISPLAY PANEL"
      ' Enable triggered measurement mode.
      GpibWrite iAP, "TRIGGER ON"
      ' Query for operation complete to assure input queue has been
  
```

```

' processed before Group Execute Trigger message is sent.
GpibWrite iAP, "*OPC?"
' Read *OPC? response to assure complete input queue processing.
sOPC = GpibRead(iAP, BUFLLENGTH)
' Query the triggered measurement.
' Measurement waits for a trigger event.
GpibWrite iAP, "*CLS;M1?;M2?;MF?;MP?;*OPC"
' Trigger a measurement with GPIB Group Execute Trigger.
iStatus = iltrg(iAP)
' Serial poll until the OPC bit is set (Operation Complete)
' in the Status Byte Register.
Do
  ' Read the instrument status byte with a Serial Poll.
  iStatus = ilrsp(iAP, iSPR)
  ' Let other Windows tasks run too.
  DoEvents
Loop While (iSPR And 32) <> 32  ' Check for the OPC bit set.
' Change signal level.
' Triggered measurement should not be affected.
GpibWrite iAP, "*CLS;GAMPLITUDE -30 DBV;GFREQUENCY 1000 HZ"
' Read the triggered measurement.
' The measurement should be -10 DBV.
sData = GpibRead(iAP, BUFLLENGTH)
' Display the triggered measurement.
sMsg = "Triggered Stereo Level, Frequency, and Interchannel "
sMsg = sMsg & "Phase measurements are displayed "
sMsg = sMsg & "on the instrument." & vbCrLf & vbCrLf
sMsg = sMsg & "Measurements should be -10 DBV, 500 Hz, and 0 Deg."
sMsg = sMsg & vbCrLf & vbCrLf & "Measurements are: " & sData
MsgBox sMsg, vbOKOnly, MSGBOX_TITLE
' Disable triggered measurement mode and return to
' free-run measurement mode.
GpibWrite iAP, "TRIGGER OFF;GAMPLITUDE 0 DBV"
End If
' Analog Distortion VS Frequency Sweep.
sMsg = "Ready to run Channel A Distortion vs "
sMsg = sMsg & "Generator Frequency Sweep" & vbCrLf & vbCrLf
sMsg = sMsg & "The sweep graph will be displayed on the "
sMsg = sMsg & "instrument front panel." & vbCrLf
' Continue if OK selected else end the program.
If MsgBox((sMsg), vbOKCancel, MSGBOX_TITLE) = vbOK Then
  ' Setup for THD+N measurements
  ' Set the instrument for 3 sweep steps (4 measurement points).
  ' Change the STEPS argument if more sweep steps are desired.
  ' Change the FMIN and FMAX arguments if a different sweep
  ' frequency range is desired.
GpibWrite iAP, ":INPUT GENA;OUTPUT A;GAMPLITUDE 1 V;"
GpibWrite iAP, ":FUNCTION THD;:THD:LPASS R22K;TUNE GENTRACK"
GpibWrite iAP, ":THD:SWPTYPE FREQ;STEPS 3;FMIN 20;FMAX 20000"
  ' Clear the Status Registers and start a sweep.
  ' After the sweep is complete set the OPC bit in the
  ' Event Status Register with *OPC in order to set the
  ' Event Status Bit in the Status Byte Register.
GpibWrite iAP, "*CLS;SWEEP START;*OPC"
  ' Serial poll until the OPC bit is set (Operation Complete)
  ' in the Status Byte Register.
Do
  ' Read the instrument status byte with a Serial Poll.
  iStatus = ilrsp(iAP, iSPR)
  ' Let other Windows tasks run too.
  DoEvents
Loop While (iSPR And 32) <> 32  ' Check for the OPC bit set.
' Query for sweep frequency data.
GpibWrite iAP, "*CLS;DATAF?"
' Read the sweep frequency data.
sFreq = GpibRead(iAP, BUFLLENGTH)
' Query for THD measurement sweep data.
GpibWrite iAP, "DATA1?"
' Read the THD measurement sweep data.
sData = GpibRead(iAP, BUFLLENGTH)
' Format text lines for data display in a VB message box.

```

```

sMsg = "Distortion vs Frequency Sweep Results" & vbCrLf & vbCrLf
sMsg = sMsg & "Generator Sweep Frequency query response: "
sMsg = sMsg & vbCrLf & sFreq & vbCrLf & vbCrLf
sMsg = sMsg & "Analyzer THD+N Sweep Measurement query response: "
sMsg = sMsg & vbCrLf & sData
MsgBox sMsg, vbOKOnly, MSGBOX_TITLE
End If

' Analog Gain Linearity Sweep
sMsg = "Ready to run Channel A Gain Linearity Sweep" & vbCrLf
sMsg = sMsg & vbCrLf & "Channel A Bandpass Amplitude Measurement"
sMsg = sMsg & " vs Generator Amplitude" & vbCrLf & vbCrLf
sMsg = sMsg & "The sweep graph will be displayed on the "
sMsg = sMsg & "instrument front panel." & vbCrLf
' Continue if OK selected else end.
If MsgBox((sMsg), vbOKCancel, MSGBOX_TITLE) = vbOK Then
' Change STEPS argument if more sweep steps are desired.
' Change AMIN and AMAX arguments if a different
' sweep amplitude range is desired.
GpibWrite iAP, ":GAMPLITUDE 0 DBV;:FUNCTION AMPL"
GpibWrite iAP, ":AMPL:FILTER SELECTIVE;UNIT DBV"
GpibWrite iAP, ":AMPL:SWPTYPE AMPLITUDE;STEPS 3"
GpibWrite iAP, ":AMPL:AMIN -60 DBV;AMAX 0 DBV"
' Clear the Status Registers and start a sweep.
' After the sweep is complete set the OPC bit in the
' Event Status Register with *OPC in order to set the
' Event Status Bit in the Status Byte Register.
GpibWrite iAP, "*CLS;SWEEP START;*OPC"
iSPR = 0
' Serial poll until the OPC bit is set (Operation Complete)
' in the Status Byte Register.
Do
' Read the instrument status byte with a Serial Poll.
iStatus = ilrsp(iAP, iSPR)
' Let other Windows tasks run too.
DoEvents
Loop While (iSPR And 32) <> 32 ' Check for the OPC bit set.
' Query for the generator sweep amplitude data.
GpibWrite iAP, "*CLS;DATAA?"
' Read the generator sweep amplitude data.
sFreq = GpibRead(iAP, BUFLLENGTH)
' Query for the analyzer bandpass amplitude measurement data.
GpibWrite iAP, "DATA1?"
' Read the analyzer bandpass amplitude measurement data.
sData = GpibRead(iAP, BUFLLENGTH)
' Format text lines for data display in a VB message box.
sMsg = "Gain Linearity Sweep Results" & vbCrLf & vbCrLf
sMsg = sMsg & "Generator Amplitude sweep query response: "
sMsg = sMsg & vbCrLf & sFreq & vbCrLf & vbCrLf
sMsg = sMsg & "Analyzer Bandpass Amplitude sweep measurement "
sMsg = sMsg & "query response: " & vbCrLf & sData
MsgBox sMsg, vbOKOnly, MSGBOX_TITLE
End If
iStatus = ilonl(iAP, 0) ' close GPIB device iAP
End If
End Sub
Sub Delay(dDelaytime As Double) ' Delay user specified time in seconds.
Dim dStart As Double
dStart = Timer
While Timer - dStart < dDelaytime
DoEvents
Wend
End Sub
Private Sub GpibWrite(iDev As Integer, sBufOut As String)
' Listen address iDev and send string
Dim iStatus As Integer, iBufOutLength As Integer
iBufOutLength = Len(sBufOut)
' Send the output string if length > 0
If iBufOutLength > 0 Then
iStatus = ilwrt(iDev, sBufOut, iBufOutLength)
End Sub

```

```

Function GpibRead(iDev As Integer, iBufLen As Integer) As String
    ' Talk address GPIB instrument at address iDev and read the
    ' response into string variable GpibRead.
    Dim iStatus As Integer
    ' Set the size of the input buffer.
    GpibRead = Space(iBufLen)
    ' Read the GPIB response string.
    iStatus = ilrd(iDev, GpibRead, iBufLen)
    ' Trim the input string to the greater of:
    ' the length of GPIB input buffer or the length of the input string.
    GpibRead = Left(GpibRead, ibcnt)
End Function

Function FindAP(sID As String, iAddr As Integer) As Integer
    ' Find the first GPIB listener that is an ATS-1 Access
    ' or an ATS-1 Dual Domain or a Portable One Plus Access
    ' or a Portable One Dual Domain.
    ' If found then return the instrument's *IDN? response string
    ' and it's GPIB address.
    ' Assume the GPIB controller primary address is 0.
    Dim iListenerFound As Integer, iDev As Integer, iBoard As Integer
    Dim sResponse As String, iStatus As Integer
    iAddr = 0      ' Initialize GPIB address to 0.
    sID = ""      ' Initialize GPIB device identification to null string.
    iBoard = ilfind(sBoard)      ' Get GPIB board descriptor for BOARD.
    iStatus = ilsic(iBoard)      ' Clear GPIB.
    iStatus = ilsre(iBoard, 1)   ' Assert Remote Enable.
    Do
        iAddr = iAddr + 1      ' Increment the GPIB address, starting with 1.
        ' Open communications to GPIB address iAddr with 3 second timeout.
        iDev = ildev(BOARD, iAddr, NO_SAD, T3s, 1, 0)
        ' GPIB listener at this address?
        iStatus = illn(iDev, iAddr, NO_SAD, iListenerFound)
        If iListenerFound Then      ' A GPIB listener was found.
            iStatus = ilclr(iDev)      ' Send Select Device Clear (SDC).
            ' Send a query for Instrument Identification.
            GpibWrite iDev, "*IDN?"
            sResponse = GpibRead(iDev, 60)      ' Read the query response.
            ' Search query response string if no GPIB read error.
            If (ibsta And EERR) = 0 Then
                ' Is it ATS-1 Access?
                If InStr(1, sResponse, ATSlA) Then
                    sID = ATSlA
                ' Is it ATS-1 Dual Domain?
                ElseIf InStr(1, sResponse, ATSlDD) Then
                    sID = ATSlDD
                ' Is it Portable One Plus Access?
                ElseIf InStr(1, sResponse, PlPA) Then
                    sID = PlPA
                ' Is it Portable One Dual Domain?
                ElseIf InStr(1, sResponse, PlDD) Then
                    sID = PlDD
                End If
                ' If the search is successful then initialize the instrument
                ' I/O and exit this function.
                If sID <> "" Then
                    FindAP = iDev      ' Set the instrument device number.
                    Exit Function
                End If
            Else
                MsgBox "The instrument at address " & iAddr _
                    & " does not respond to *IDN?" & vbCrLf _
                    & AddIbsta & AddIberr, vbOKOnly, MSGBOX_TITLE
            End If
        End If
        ' Close the instruments GPIB device I/O if it's *IDN?
        ' query response does not match the search criterion.
        iStatus = ilonl(iDev, 0)
    Loop While iAddr < 31      ' Address 30 is the last valid address.
    ' No instrument *IDN? response matched the search criterion.

```

```

FindAP = NOTFOUND
End Function

Function AddIberr() As String
' Return a GPIB interface error message string by examining
' the bits in the ibsta variable.
If (ibsta And EERR) Then
  If (iberr = EDVR) Then
    AddIberr = vbCrLf & "iberr = EDVR <DOS Error>"
  If (iberr = ECIC) Then
    AddIberr = vbCrLf & "iberr = ECIC <Not CIC>"
  If (iberr = ENOL) Then
    AddIberr = vbCrLf & "iberr = ENOL <No Listener>"
  If (iberr = EADR) Then
    AddIberr = vbCrLf & "iberr = EADR <Address Error>"
  If (iberr = EARG) Then
    AddIberr = vbCrLf & "iberr = EARG <Invalid argument>"
  If (iberr = ESAC) Then
    AddIberr = vbCrLf & "iberr = ESAC <Not Sys Ctrlr>"
  If (iberr = EABO) Then
    AddIberr = vbCrLf & "iberr = EABO <Op. aborted>"
  If (iberr = ENEB) Then
    AddIberr = vbCrLf & "iberr = ENEB <No GPIB board>"
  If (iberr = EOIP) Then
    AddIberr = vbCrLf & "iberr = EOIP <Async I/O in prg>"
  If (iberr = ECAP) Then
    AddIberr = vbCrLf & "iberr = ECAP <No capability>"
  If (iberr = EFSO) Then
    AddIberr = vbCrLf & "iberr = EFSO <File sys. error>"
  If (iberr = EBUS) Then
    AddIberr = vbCrLf & "iberr = EBUS <Command error>"
  If (iberr = ESTB) Then
    AddIberr = vbCrLf & "iberr = ESTB <Status byte lost>"
  If (iberr = ESRQ) Then
    AddIberr = vbCrLf & "iberr = ESRQ <SRQ stuck high>"
  If (iberr = ETAB) Then
    AddIberr = vbCrLf & "iberr = ETAB <Table overflow>"
  Else
    AddIberr = vbCrLf & "iberr = " & Str$(iberr)
  End If
End Function

Function AddIbsta() As String
' Return a GPIB interface error message string by examining
' the bits in the ibsta variable.
AddIbsta = vbCrLf & "ibsta = &H" & Hex$(ibsta) & " <"
If (ibsta And EERR) Then AddIbsta = AddIbsta & " ERR"
If (ibsta And TIMO) Then AddIbsta = AddIbsta & " TIMO"
If (ibsta And EEND) Then AddIbsta = AddIbsta & " END"
If (ibsta And SRQI) Then AddIbsta = AddIbsta & " SRQI"
If (ibsta And RQS) Then AddIbsta = AddIbsta & " RQS"
If (ibsta And CMPL) Then AddIbsta = AddIbsta & " CMPL"
If (ibsta And LOK) Then AddIbsta = AddIbsta & " LOK"
If (ibsta And RREM) Then AddIbsta = AddIbsta & " REM"
If (ibsta And CIC) Then AddIbsta = AddIbsta & " CIC"
If (ibsta And AATN) Then AddIbsta = AddIbsta & " ATN"
If (ibsta And TACS) Then AddIbsta = AddIbsta & " TACS"
If (ibsta And LACS) Then AddIbsta = AddIbsta & " LACS"
If (ibsta And DTAS) Then AddIbsta = AddIbsta & " DTAS"
If (ibsta And DCAS) Then AddIbsta = AddIbsta & " DCAS"
AddIbsta = AddIbsta & ">"
End Function

```

## Settings Recall Sample Program

This program shows how the instrument saved settings may be recalled with the \*RCL and \*LRN? commands and how the settings may be saved in computer files. These files may be used later by the SAVSample.BAS program to save these settings into the same registers on another instrument. This capability allows a suite of test settings to be created manually on one instrument and then copied to other instruments. See the comments at the beginning of the program listing below for more information. The displays below illustrate the normal messages presented while the program is running.

The Visual Basic 5.0 program below resides in one module file RCLSample.BAS. It requires a National Instruments GPIB interface card with a driver for Windows 95 and the two modules NIGLOBAL.BAS and VBIB-32.BAS, version 1.6 or later. This code and its VB 5.0 form file, and an installable compiled executable are on the sample program CD provided with this manual. Run the setup program in the RCLSample directory of the GPIB CD in order to install the program and the source code.

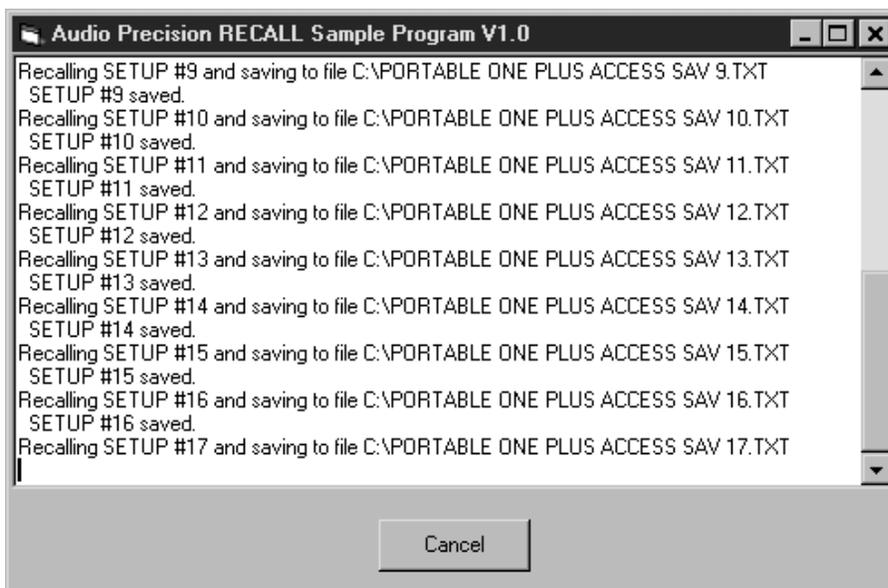
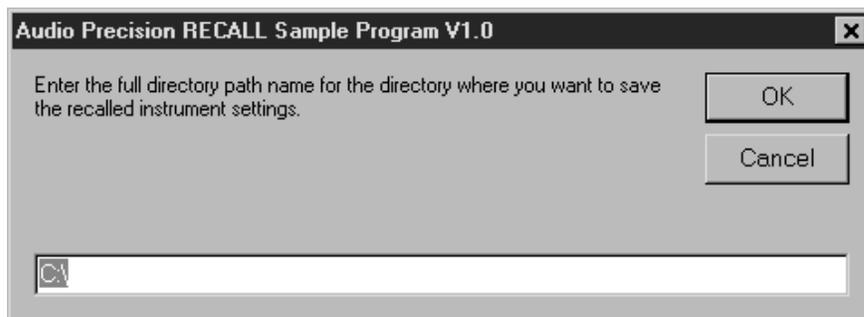



## Settings Recall Sample Program Listing

```
' RCLSample.bas - Version 1.0
' Example GPIB program for Microsoft Visual Basic 5.0
' August 4,1998, Copyright (c) 1998 Audio Precision Inc.
' All Rights Reserved
' An example of instrument setup RECALL with National Instruments
' GPIB interface for Win95.
' This program recalls each of 30 valid instrument setups saved
' in non-volatile instrument memory and then adds the
' *SAV n;NAME n,"abc" commands. The name is acquired from the
' instrument. The entire setup string is then written to a
' diskfile for later use by the SAVsample.bas example program.
' Supports Audio Precision models: ATS-1 Access, ATS-1 Dual Domain,
' Portable One Plus Access, and Portable One Dual Domain.
' Uses module "Niglobal.bas" and "Vbib-32.bas" ver 1.6 for VB 5.0
' from National Instruments Corp.
```

Option Explicit

```
Public sBoard As String, iAP As Integer, iStatus As Integer
Public Const MSGTITLE = "Audio Precision RECALL Sample Program V1.0"
' GPIB board number (0, 1, 2, or 3), change if your board is other
Public Const BOARD = 0
' GPIB input buffer byte length, must be large enough to receive
' an instrument query response.
Const BUFLLENGTH = 5000 ' GPIB input buffer byte length
Const GPIB_ERR = 488
Const NOTFOUND = -1
Const ATS1A = "ATS-1 ACCESS"
Const ATS1DD = "ATS-1 DUAL DOMAIN"
Const P1PA = "PORTABLE ONE PLUS ACCESS"
Const P1DD = "PORTABLE ONE DUAL DOMAIN"
' VB 5.0 Startup Object is Form1
```

Sub Main()

```
Dim iSPR As Integer, iAddr As Integer, iFileNumber As Integer
Dim sTxt As String, iSAVED As Integer, sNAME As String
Dim sFilename As String, sPATH As String, iSAV As Integer
Dim sMsg As String, sID As String, sERR As String, sLRN As String
Form1.Status.Text = ""
On Error GoTo errhandler
sPATH = "C:\" ' Change this to your preferred default path.
iSAVED = 0
sBoard = "GPIB" & Right(Str(BOARD), 1)
sERR = Space(100)
sLRN = Space(BUFLLENGTH)
' Find the first GPIB listener connected to this GPIB interface
' board that is an ATS-1 Access, ATS-1 Dual Domain,
' Portable One Plus Access, or a Portable One Dual Domain.
' Return an instrument ID and GPIB address if found.
iAP = FindAP(sID, iAddr)
If iAP = NOTFOUND Then
' The GPIB search for the instrument failed. Exit the program.
sMsg = "An " & ATS1A & " or " & ATS1DD & " or " & P1PA _
& " or " & P1DD & " was not found on " & sBoard
MsgBox sMsg, vbExclamation, MSGTITLE
' Quit the program by executing cmdCancel_Click event.
Form1.cmdCancel_Click
Else ' Search successful
' The GPIB search for the instrument was successful.
' Clear status registers and reset the instrument to defaults.
```

```

GpibWrite iAP, "*CLS;*RST"
sMsg = sID & " at GPIB address " & iAddr
sMsg = sMsg & " on " & sBoard & vbCrLf & vbCrLf
sMsg = sMsg & "Ready to Recall all Saved instrument setups"
sMsg = sMsg & vbCrLf & "and store them on disk?" & vbCrLf
' Continue if OK selected else end.
If MsgBox(sMsg), vbOKCancel, MSGTITLE) = vbOK Then
    sMsg = "Enter the full directory path name for the directory"
    sMsg = sMsg & " where you want to save the recalled"
    sMsg = sMsg & " instrument settings."
    sPATH = InputBox$(sMsg, MSGTITLE, sPATH)
    ' Cancel ifCANCEL button clicked or null directory
    If sPATH = "" Then Form1.cmdCancel_Click
    ' Begin retrieving valid stored settings
    For iSAV = 0 To 29
        DoEvents
        GpibWrite iAP, "*RCL " & iSAV _
            & ";VERBOSE OFF;HEADER OFF;ERRM?"
        ' Read ERRM? response, then continue.
        sERR = GpibRead(iAP, BUFLNGTH)
        ' If no *RCL error then continue, else abort recall of
        ' this saved setup.
        If Val(sERR) = 0 Then
            sFilename = sPATH & sID & " SAV" & Str$(iSAV) & ".TXT"
            sTxt = sTxt & "Recalling SETUP #" & iSAV _
                & " and saving to file " & sFilename & vbCrLf
            StatusUpdate sTxt
            ' Delete the setup file if it exists,
            ' but not if write protected.
            Kill sFilename
            ' Save the settings to a file with file name "SAV n"
            ' Alternative file I/O when using National Instruments
            ' boards.
            '
            iStatus = ilrdf(iAP, sFilename)
            ' All other boards use explicit file I/O shown below.
            iFileNumber = FreeFile
            ' Create filename.
            Open sFilename For Binary Access Write As #iFileNumber
            GpibWrite iAP, "HEADER ON;*LRN?"
            sLRN = GpibRead(iAP, BUFLNGTH)
            DoEvents
            ' Query name of recalled setup.
            GpibWrite iAP, "NAME? " & iSAV
            ' Read name of recalled setup.
            sNAME = GpibRead(iAP, 50)
            sLRN = sLRN & "*SAV " & iSAV & ";" & sNAME
            ' Write the recalled setup string to disk file.
            Put #iFileNumber, , sLRN
            Close #iFileNumber          ' Close file.
            iSAVED = iSAVED + 1
            sTxt = sTxt & " SETUP #" & iSAV & " saved." & vbCrLf
            StatusUpdate sTxt
        End If
    error_exit: ' file access error exit point if error 75
    Next iSAV
    ' Format lines for data display in VB message box.
    sMsg = "Recalled " & iSAVED & " instrument setups from the" _
        & vbCrLf & sID
    MsgBox sMsg, vbOKOnly + vbInformation, MSGTITLE
Else
    ' Quit the program by executing cmdCancel_Click event.
    Form1.cmdCancel_Click
End If
' abort the program due to user Abort button
' on file error dialog.
error_abort:
End If
Exit Sub

errhandler:
Select Case Err.Number

```

```

Case vbObjectError + GPIB_ERR
    sMsg = Err.Description & vbCrLf & vbCrLf
    sMsg = sMsg & "Abort this session?"
    Select Case MsgBox(sMsg, vbOKCancel + vbCritical, MSGTITLE)
        Case vbOK
            Resume error_abort ' abort setup save for this file
        Case vbCancel
            Resume Next ' ignore
    End Select
Case 53 ' File not found, ignore
    Resume Next
Case 75 ' File access error, file write protected
    sMsg = "Error " & Err.Number & " - " & Err.Description _
        & " for file " & sFilename & vbCrLf
    sMsg = sMsg & "Write or Delete not permitted "
    sMsg = sMsg & "(probably read-only)." & vbCrLf _
        & "Setup Save Aborted!"
    If MsgBox(sMsg, vbOKCancel, MSGTITLE) = vbCancel Then Resume
error_abort
    sMsg = ""
    Resume error_exit ' abort setup save for this file
Case Else ' Other errors ignored
    sERR = "Error " & Err.Number & " - " & Err.Description _
        & " for file " & sFilename
    Select Case MsgBox(sERR, vbAbortRetryIgnore, MSGTITLE)
        Case vbIgnore
            Resume Next
        Case vbAbort
            Resume error_abort ' abort setup save for this file
        Case vbRetry
            Resume
        Case Else
            Resume error_exit ' abort setup save for this file
    End Select
    sERR = ""
End Select
End Sub
Sub StatusUpdate(sTxt As String)
    Form1.Status.Text = sTxt
    Form1.Status.Refresh
    Form1.Status.SelStart = Len(sTxt)
    DoEvents
End Sub

Sub GpibWrite(iDev As Integer, sBufOut As String)
    ' Listen address iDev and send string
    Dim iStatus As Integer, iBufOutLength As Integer
    iBufOutLength = Len(sBufOut)
    ' Send the output string if length > 0
    If iBufOutLength > 0 Then
        iStatus = ilwrt(iDev, sBufOut, iBufOutLength)
    End If
    If (ibsta And EERR) <> 0 Then
        Err.Raise vbObjectError + GPIB_ERR, , "GPIB Write Error" _
            & vbCrLf & AddIberr & AddIbsta
    End If
End Sub

Function GpibRead(iDev As Integer, iBufLength As Integer) As String
    ' Talk address iDev and read response into GpibRead
    Dim iStatus As Integer
    ' Set size of input buffer
    GpibRead = Space(iBufLength)
    ' Read GPIB response string
    iStatus = ilrd(iDev, GpibRead, iBufLength)
    If (ibsta And EERR) <> 0 Then
        Err.Raise vbObjectError + GPIB_ERR, , "GPIB Read Error" _
            & vbCrLf & AddIberr & AddIbsta
    End If
    ' Trim input string to greater of
    ' length of GPIB input buffer or length of input string

```

```

    GpibRead = Left(GpibRead, ibcnt)
End Function
Function FindAP(sID As String, iAddr As Integer) As Integer
' Find the first GPIB listener that is an ATS-1 Access
' or an ATS-1 Dual Domain or a Portable One Plus Access
' or a Portable One Dual Domain.
' If found then return the instrument's *IDN? response string
' and it's GPIB address.
' Assume the GPIB controller primary address is 0.
Dim iListenerFound As Integer, iDev As Integer
Dim sResponse As String, iStatus As Integer, iBoard As Integer
iAddr = 0      ' Initialize GPIB address to 0.
sID = ""      ' Initialize GPIB device identification to null.
' Get GPIB board descriptor for BOARD.
iBoard = ilfind(sBoard)
' Clear GPIB.
iStatus = ilsic(iBoard)
' Assert Remote Enable.
iStatus = ilsre(iBoard, 1)
Do
' Increment the GPIB address, starting with 1.
iAddr = iAddr + 1
' Open communications to address iAddr with 3 sec timeout.
iDev = ildev(BOARD, iAddr, NO_SAD, T3s, 1, 0)
' GPIB listener at this address?
iStatus = illn(iDev, iAddr, NO_SAD, iListenerFound)
If iListenerFound Then ' A GPIB listener was found.
    iStatus = ilclr(iDev) ' Send Select Device Clear (SDC).
    ' Send a query for Instrument Identification.
    GpibWrite iDev, "*IDN?"
    sResponse = GpibRead(iDev, 60) ' Read the query response.
    ' Search query response string if no GPIB read error.
    If (ibsta And EERR) = 0 Then
        ' Is it ATS-1 Access?
        If InStr(1, sResponse, ATSlA) Then
            sID = ATSlA
        ' Is it ATS-1 Dual Domain?
        ElseIf InStr(1, sResponse, ATSlDD) Then
            sID = ATSlDD
        ' Is it Portable One Plus Access?
        ElseIf InStr(1, sResponse, P1PA) Then
            sID = P1PA
        ' Is it Portable One Dual Domain?
        ElseIf InStr(1, sResponse, P1DD) Then
            sID = P1DD
        End If
        ' If the search is successful then initialize the
        ' instrument I/O and exit this function.
        If sID <> "" Then
            FindAP = iDev ' Set the instrument device number.
            ' Put the instrument into Remote With Lockout State
            ' in order to prevent the user from changing the front
            ' panel during GPIB I/O.
            SendLLO (BOARD)
            Exit Function
        End If
    Else
        MsgBox "The instrument at address " & iAddr _
            & " does not respond to *IDN?" & vbCrLf _
            & AddIbsta & AddIberr, vbOKOnly, MSGTITLE
    End If
End If
' Close the instruments GPIB device I/O if it's *IDN? query
' response does not match the search criterion.
iStatus = ilonl(iDev, 0)
Loop While iAddr < 31 ' Address 30 is the last valid address.
' No instrument *IDN? response matched the search criterion.
FindAP = NOTFOUND
End Function

Function AddIberr() As String

```

```

' Return a GPIB interface error message string by examining
' the bits in the ibsta variable.
If (ibsta And EERR) Then
  If (iberr = EDVR) Then
    AddIberr = vbCrLf & "iberr = EDVR <DOS Error>"
  If (iberr = ECIC) Then
    AddIberr = vbCrLf & "iberr = ECIC <Not CIC>"
  If (iberr = ENOL) Then
    AddIberr = vbCrLf & "iberr = ENOL <No Listener>"
  If (iberr = EADR) Then
    AddIberr = vbCrLf & "iberr = EADR <Address Error>"
  If (iberr = EARG) Then
    AddIberr = vbCrLf & "iberr = EARG <Invalid argument>"
  If (iberr = ESAC) Then
    AddIberr = vbCrLf & "iberr = ESAC <Not Sys Ctrlr>"
  If (iberr = EABO) Then
    AddIberr = vbCrLf & "iberr = EABO <Op. aborted>"
  If (iberr = ENEB) Then
    AddIberr = vbCrLf & "iberr = ENEB <No GPIB board>"
  If (iberr = EOIP) Then
    AddIberr = vbCrLf & "iberr = EOIP <Async I/O in prg>"
  If (iberr = ECAP) Then
    AddIberr = vbCrLf & "iberr = ECAP <No capability>"
  If (iberr = EFSO) Then
    AddIberr = vbCrLf & "iberr = EFSO <File sys. error>"
  If (iberr = EBUS) Then
    AddIberr = vbCrLf & "iberr = EBUS <Command error>"
  If (iberr = ESTB) Then
    AddIberr = vbCrLf & "iberr = ESTB <Status byte lost>"
  If (iberr = ESRQ) Then
    AddIberr = vbCrLf & "iberr = ESRQ <SRQ stuck high>"
  If (iberr = ETAB) Then
    AddIberr = vbCrLf & "iberr = ETAB <Table overflow>"
Else
  AddIberr = vbCrLf & "iberr = " & Str$(iberr)
End If
End Function

Private Function AddIbsta() As String
  AddIbsta = vbCrLf + "ibsta = &H" + Hex$(ibsta) + " <"
  If (ibsta And EERR) Then AddIbsta = AddIbsta + " ERR"
  If (ibsta And TIMO) Then AddIbsta = AddIbsta + " TIMO"
  If (ibsta And EEND) Then AddIbsta = AddIbsta + " END"
  If (ibsta And SRQI) Then AddIbsta = AddIbsta + " SRQI"
  If (ibsta And RQS) Then AddIbsta = AddIbsta + " RQS"
  If (ibsta And CMPL) Then AddIbsta = AddIbsta + " CMPL"
  If (ibsta And LOK) Then AddIbsta = AddIbsta + " LOK"
  If (ibsta And RREM) Then AddIbsta = AddIbsta + " REM"
  If (ibsta And CIC) Then AddIbsta = AddIbsta + " CIC"
  If (ibsta And AATN) Then AddIbsta = AddIbsta + " ATN"
  If (ibsta And TACS) Then AddIbsta = AddIbsta + " TACS"
  If (ibsta And LACS) Then AddIbsta = AddIbsta + " LACS"
  If (ibsta And DTAS) Then AddIbsta = AddIbsta + " DTAS"
  If (ibsta And DCAS) Then AddIbsta = AddIbsta + " DCAS"
  AddIbsta = AddIbsta + ">"
End Function

```

## Settings Save Sample Program

This sample program shows how the instrument settings recalled from the instrument by the RCLSample.BAS program and saved as disk files may be saved in their original registers on the same or different instrument. This capability allows a suite of test settings to be created manually on one instrument and then copied to other instruments. See the comments at the beginning of the program listing below for more information. The displays below illustrate the normal messages presented while the program is running.

The Visual Basic 5.0 program below resides in one module file RCLSample.BAS. It requires a National Instruments GPIB interface card with a driver for Windows 95 and the two modules NIGLOBAL.BAS and VBIB-32.BAS, version 1.6 or later. This code and its VB 5.0 form file, and an installable compiled executable are on the sample program CD provided with this manual. Run the setup program in the SAVSample directory of the CD in order to install the program and the source code.

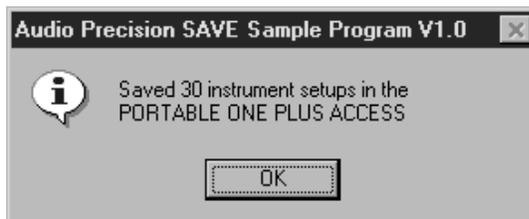
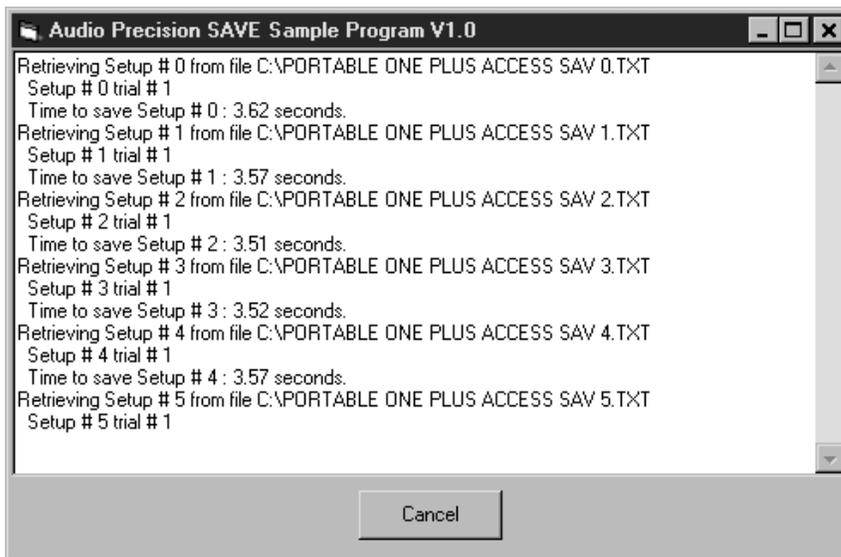
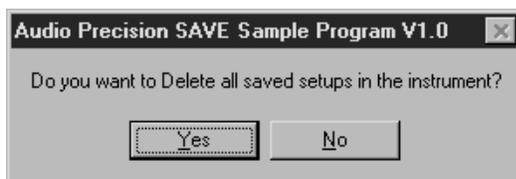
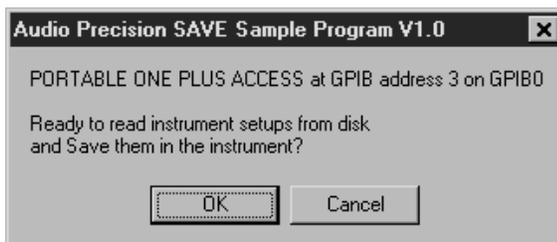

## Settings Save Sample Program Listing

```
' SAVSample.bas - Version 1.0
' Example GPIB program for Microsoft Visual Basic 5.0
' August 5,1998, Copyright (c) 1998 Audio Precision Inc.
' All Rights Reserved
' An example of instrument setup SAVE with National Instruments
' GPIB interface for Win95.
' Supports Audio Precision models: ATS-1 Access, ATS-1 Dual Domain,
' Portable One Plus Access, and Portable One Dual Domain.
' Uses module "Niglobal.bas" and "Vbib-32.bas" ver 1.6 for VB 5.0
' from National Instruments Corp.

Option Explicit
Public sBoard As String, iAP As Integer, iStatus As Integer
Public Const MSGTITLE = "Audio Precision SAVE Sample Program V1.0"
' GPIB board number 0, change if your board is other (0,1,2, or 3)
Public Const BOARD = 0
' GPIB input buffer byte length, must be large enough to receive
' an instrument query response.
Const BUFLLENGTH = 5000
Const ATS1A = "ATS-1 ACCESS"
Const ATS1DD = "ATS-1 DUAL DOMAIN"
Const P1PA = "PORTABLE ONE PLUS ACCESS"
Const P1DD = "PORTABLE ONE DUAL DOMAIN"
Const NOTFOUND = -1
Const TRIALS = 3 ' Number of times to retry loading each setup
' VB 5.0 Startup Object is Form1

Sub Main()
    Dim iSPR As Integer, iAddr As Integer, iFileNumber As Integer
    Dim sFilename As String, lSetupFileLen As Long, iSAVED As Integer
    Dim iSavTry As Integer, iSAV As Integer, sMsg As String
    Dim iERR As Integer, sLRN As String, dTime As Double
    Dim sID As String, sERR As String, sRCL As String
    Dim dStartTime As Double, sTxt As String, sPATH As String
    On Error GoTo file_error_handler
    iSAVED = 0
    sPATH = "C:\"
    Form1.Status.Text = ""
    sBoard = "GPIB" & Right(Str(BOARD), 1)
    sERR = Space(100)
    sLRN = Space(BUFLLENGTH)
    ' Find the first GPIB listener connected to this GPIB interface
    ' board that is an ATS-1 Access, ATS-1 Dual Domain,
    ' Portable One Plus Access, or a Portable One Dual Domain.
    ' Return an instrument ID and GPIB address if found.
    iAP = FindAP(sID, iAddr)
    If iAP = NOTFOUND Then
        ' The GPIB search for the instrument failed. Exit the program.
        sMsg = "An " & ATS1A & " or " & ATS1DD & " or " & P1PA _
            & " or " & P1DD & " was not found on " & sBoard
        MsgBox sMsg, vbExclamation, MSGTITLE
        ' Quit the program by executing cmdCancel_Click event.
        Form1.cmdCancel_Click
    Else
        ' The GPIB search for the instrument was successful.
        ' Clear status registers and reset the instrument to defaults.
        GpibWrite iAP, "*CLS;*RST"
        sMsg = sID & " at GPIB address " & iAddr
        sMsg = sMsg & " on " & sBoard & vbCrLf & vbCrLf
        sMsg = sMsg & "Ready to read instrument setups from disk"
        sMsg = sMsg & vbCrLf & "and Save them in the instrument?"
        ' Continue if OK selected else end.
        If MsgBox(sMsg, vbOKCancel, MSGTITLE) = vbOK Then
            ' Get user's saved instrument setup files directory path.

            sMsg = "Enter the full directory path name that contains"
            sMsg = sMsg & " the instrument settings."
            sPATH = InputBox$(sMsg, MSGTITLE, sPATH)
            ' Cancel if CANCEL button clicked or null directory
```

```

If sPATH = "" Then Form1.cmdCancel_Click
' Delete all currently saved setups before beginning?
sMsg = "Do you want to Delete all saved setups "
sMsg = sMsg & "in the instrument?"
GpibWrite iAP, "VERB OFF;HEAD OFF"
If MsgBox(sMsg, vbYesNo, MSGTITLE) = vbYes Then
  For iSAV = 0 To 29
    ' Delete saved setups that are not already deleted.
    ' Turn DELETE OFF if DELETE ON.
    ' Cannot turn PROTECT OFF if PROTECT ON with DELETE ON.
    GpibWrite iAP, "DELETE? " & iSAV
    sERR = GpibRead(iAP, BUFLLENGTH)
    If InStr(1, sERR, "ON") > 0 Then
      GpibWrite iAP, "DELETE " & iSAV & ",OFF"
    End If
    GpibWrite iAP, "PROTECT " & iSAV & _
      ",OFF;DELETE " & iSAV & ",ON"
  Next iSAV
End If
' Begin retrieving valid stored settings from file.
sTxt = ""
For iSAV = 0 To 29
  DoEvents
  ' If no setup error then check protect mode and save
  ' the setup.
  GpibWrite iAP, "VERB OFF;HEAD OFF;PROT? " & iSAV
  ' Read instrument setup register protect query response
  sERR = GpibRead(iAP, BUFLLENGTH)
  ' If Protection is Off then proceed to save the setup.
  If InStr(1, sERR, "OFF") > 0 Then
    sFilename = sPATH & sID & " SAV" & Str$(iSAV) & ".TXT"
    sTxt = sTxt & "Retrieving Setup # " & iSAV
    sTxt = sTxt & " from file " & sFilename & vbCrLf
    StatusUpdate sTxt
    iFileNumber = FreeFile
    ' Create filename.
    Open sFilename For Binary Access Read _
      As #iFileNumber
    lSetupFileLen = LOF(iFileNumber)
    ' File has no data (did not previously exist)
    ' therefor continue with next file.
    If lSetupFileLen = 0 Then
      sTxt = sTxt & " File " & sFilename
      sTxt = sTxt & " does not exist." & vbCrLf & vbCrLf
      StatusUpdate sTxt
      Close #iFileNumber ' Close the file
      GoTo NoFile
    End If
    sRCL = Space(LOF(iFileNumber))
    ' Read setup data from the file.
    Get #iFileNumber, , sRCL
    Close #iFileNumber ' Close the file
    dStartTime = Timer
    ' Try multiple times to send setup data to the
    ' instrument without errors.
    For iSavTry = 1 To TRIALS
      sTxt = sTxt & " Setup # " & iSAV
      sTxt = sTxt & " trial # " & iSavTry & vbCrLf
      StatusUpdate sTxt
      GpibWrite iAP, sRCL ' Send setup
      ' Send ERRM? query to detect when setup is complete.
      GpibWrite iAP, "HEAD OFF;VERB OFF;ERRM?"
      ' Read ERRM? response with a long timeout to allow
      ' the instrument to process the long setup string.
      sERR = GpibReadT(iAP, BUFLLENGTH)
      ' sERR = GpibRead(iAP, BUFLLENGTH)
      dTime = Timer - dStartTime
      ' If valid error response then test error code
      ' else continue with next setup.
      If sERR <> "" Then
        iERR = Val(sERR)

```

```

' If specific errors then retry setup else continue
' with next setup.
If iERR = 1 Or iERR = 2 Or iERR = 7 Or iERR = 8 _
Or iERR = 10 Or iERR = 14 Or iERR = 16 Or iERR = 18 _
Or iERR = 19 Or iERR = 20 Then
    sTxt = sTxt & " Instrument Error " _
        & sERR & vbCrLf
    StatusUpdate sTxt
    If iSavTry = TRIALS Then
        GpibWrite iAP, "DELETE " & iSAV & ",ON"
        sTxt = sTxt & " Save Setup " & iSAV
        sTxt = sTxt & " Failed - Setup DELETED" & vbCrLf
        StatusUpdate sTxt
    End If
    ' Fall through into retry loop.
Else
    ' Save setup was successful.
    ' PROTECT all successfully saved setups.
    GpibWrite iAP, "PROT " & iSAV & ",ON"
    sTxt = sTxt & " Time to save Setup # " & iSAV _
        & " : " & Format(dTime, "FIXED") _
        & " seconds." & vbCrLf
    StatusUpdate sTxt
    ' No error, exit the retry loop.
    iSAVED = iSAVED + 1
    Exit For
End If
Else
    sTxt = sTxt & " Instrument Error: " _
        & "No ERRM? query response. Save Setup # " _
        & iSAV & " Failed." & vbCrLf
    StatusUpdate sTxt
    ' Exit retry loop if no ERRM? query response
    ' after setup sent.
    Exit For
End If
' Retry if setting conflict errors
Next iSavTry
Else
    sTxt = sTxt & "Setup # " & iSAV & _
        " PROTECT ON - Not Saved" & vbCrLf
    StatusUpdate sTxt
End If
NoFile:
Next iSAV
sMsg = "Saved " & iSAVED & " instrument setups in the" _
    & vbCrLf & sID
MsgBox sMsg, vbOKOnly + vbInformation, MSGTITLE
' Unassert REN line to put instrument back to local state.
iStatus = ilsre(BOARD, 0)
Else
    ' Quit the program by executing cmdCancel_Click event.
    Form1.cmdCancel_Click
End If
End If
Exit Sub

file_error_handler:
sMsg = Err.Description & Err.Number & " for file " & sFilename
If MsgBox(sMsg, vbOKCancel, MSGTITLE) = vbCancel Then Exit Sub
Resume
End Sub
Sub StatusUpdate(sTxt As String)
    Form1.Status.Text = sTxt
    Form1.Status.Refresh
    Form1.Status.SelStart = Len(sTxt)
    DoEvents
End Sub
Sub GpibWrite(iDev As Integer, sBufOut As String)
    ' Set mouse pointer to arrow with hourglass
    Form1.Status.MousePointer = vbArrowHourglass

```

```

    ' Listen address iDev and send string
Dim iStatus As Integer, iBufOutLength As Integer
    ' Set 3 second input/output timeout
iStatus = iltmo(iDev, T3s)
iBufOutLength = Len(sBufOut)
    ' Send the output string if length > 0
If iBufOutLength > 0 Then _
    iStatus = ilwrt(iDev, sBufOut, iBufOutLength)
    ' Reset mouse pointer to default.
Form1.Status.MousePointer = vbDefault
End Sub

Function GpibRead(iDev As Integer, iBufLen As Integer) As String
    ' Set mouse pointer to arrow with hourglass
Form1.Status.MousePointer = vbArrowHourglass
    ' Talk address iDev and read response into GpibRead
    ' with short timeout of 10 seconds.
Dim iStatus As Integer
    ' Set 10 second input/output timeout.
iStatus = iltmo(iDev, T10s)
    ' Set size of input buffer.
GpibRead = Space(iBufLen)
    ' Read instrument response string.
iStatus = ilrd(iDev, GpibRead, iBufLen)
    ' Trim input string to greater of:
    ' length of GPIB input buffer or length of input string
GpibRead = Left(GpibRead, ibcnt)
    ' Reset mouse pointer to default.
Form1.Status.MousePointer = vbDefault
End Function

Function GpibReadT(iDev As Integer, iBufLen As Integer) As String
    ' Talk address iDev and read response into GpibReadT
    ' Use 0.3 second timeout for ilrd function, keep trying
    ' until 10 seconds have elapsed.
    ' Set mouse pointer to arrow with hourglass
Form1.Status.MousePointer = vbArrowHourglass
Dim iStatus As Integer, iSPR As Integer, iERR As Integer
Dim dStartTime As Double, dStopTime As Double
dStopTime = 10
dStartTime = Timer
GpibReadT = Space(iBufLen) ' Set size of input buffer.
    ' Set 0.3 second input/output timeout.
iStatus = iltmo(iDev, T300ms)
Do
    iStatus = ilrd(iDev, GpibReadT, iBufLen)
    DoEvents ' Let other Windows applications run.
    iERR = ibsta And EERR
    ' Loop While read timeout error and not overall timeout.
Loop While iERR And (Timer - dStartTime < dStopTime)
If iERR Then
    iStatus = ilclr(iAP) ' Clear instrument I/O with SDC.
    GpibReadT = "" ' Clear return value to null string.
Else
    ' Trim input string to greater of:
    ' length of GPIB input buffer or length of input string.
GpibReadT = Left(GpibReadT, ibcnt)
End If
    ' Reset mouse pointer to default.
Form1.Status.MousePointer = vbDefault
End Function

Function FindAP(sID As String, iAddr As Integer) As Integer
    ' Find the first GPIB listener that is an ATS-1 Access
    ' or an ATS-1 Dual Domain or a Portable One Plus Access
    ' or a Portable One Dual Domain.
    ' If found then return the instrument's *IDN? response string
    ' and it's GPIB address.
    ' Assume the GPIB controller primary address is 0.
Dim iListenerFound As Integer, iDev As Integer
Dim sResponse As String, iStatus As Integer, iBoard As Integer
iAddr = 0 ' Initialize GPIB address to 0.
sID = "" ' Initialize GPIB device identification to null.

```

```

' Get GPIB board descriptor for BOARD.
iBoard = ilfind(sBoard)
' Clear GPIB.
iStatus = ilsic(iBoard)
' Assert Remote Enable.
iStatus = ilsre(iBoard, 1)
Do
  ' Increment the GPIB address, starting with 1.
  iAddr = iAddr + 1
  ' Open communications to address iAddr with 3 sec timeout.
  iDev = ildev(BOARD, iAddr, NO_SAD, T3s, 1, 0)
  ' GPIB listener at this address?
  iStatus = illn(iDev, iAddr, NO_SAD, iListenerFound)
  If iListenerFound Then
    ' A GPIB listener was found.
    iStatus = ilclr(iDev)
    ' Send Select Device Clear (SDC).
    ' Send a query for Instrument Identification.
    GpibWrite iDev, "*IDN?"
    sResponse = GpibRead(iDev, 60)
    ' Read the query response.
    ' Search query response string if no GPIB read error.
    If (ibsta And EERR) = 0 Then
      ' Is it ATS-1 Access?
      If InStr(1, sResponse, ATS1A) Then
        sID = ATS1A
      ' Is it ATS-1 Dual Domain?
      ElseIf InStr(1, sResponse, ATS1DD) Then
        sID = ATS1DD
      ' Is it Portable One Plus Access?
      ElseIf InStr(1, sResponse, P1PA) Then
        sID = P1PA
      ' Is it Portable One Dual Domain?
      ElseIf InStr(1, sResponse, P1DD) Then
        sID = P1DD
      End If
      ' If the search is successful then initialize the
      ' instrument I/O and exit this function.
      If sID <> "" Then
        FindAP = iDev
        ' Set the instrument device number.
        ' Put the instrument into Remote With Lockout State
        ' in order to prevent the user from changing the front
        ' panel during GPIB I/O.
        SendLLO (BOARD)
        Exit Function
      End If
    Else
      MsgBox "The instrument at address " & iAddr _
        & " does not respond to *IDN?" & vbCrLf _
        & AddIbsta & AddIberr, vbOKOnly, MSGTITLE
    End If
  End If
  ' Close the instruments GPIB device I/O if it's *IDN? query
  ' response does not match the search criterion.
  iStatus = ilonl(iDev, 0)
Loop While iAddr < 31
' Address 30 is the last valid address.
' No instrument *IDN? response matched the search criterion.
FindAP = NOTFOUND
End Function

Function AddIberr() As String
' Return a GPIB interface error message string by examining
' the bits in the ibsta variable.
If (ibsta And EERR) Then
  If (iberr = EDVR) Then
    AddIberr = vbCrLf & "iberr = EDVR <DOS Error>"
  If (iberr = ECIC) Then
    AddIberr = vbCrLf & "iberr = ECIC <Not CIC>"
  If (iberr = ENOL) Then
    AddIberr = vbCrLf & "iberr = ENOL <No Listener>"
  If (iberr = EADR) Then
    AddIberr = vbCrLf & "iberr = EADR <Address Error>"
  If (iberr = EARG) Then
    AddIberr = vbCrLf & "iberr = EARG <Invalid argument>"

```

```

If (iberr = ESAC) Then
  AddIberr = vbCrLf & "iberr = ESAC <Not Sys Ctrlr>"
If (iberr = EABO) Then
  AddIberr = vbCrLf & "iberr = EABO <Op. aborted>"
If (iberr = ENEB) Then
  AddIberr = vbCrLf & "iberr = ENEB <No GPIB board>"
If (iberr = EOIP) Then
  AddIberr = vbCrLf & "iberr = EOIP <Async I/O in prg>"
If (iberr = ECAP) Then
  AddIberr = vbCrLf & "iberr = ECAP <No capability>"
If (iberr = EFSO) Then
  AddIberr = vbCrLf & "iberr = EFSO <File sys. error>"
If (iberr = EBUS) Then
  AddIberr = vbCrLf & "iberr = EBUS <Command error>"
If (iberr = ESTB) Then
  AddIberr = vbCrLf & "iberr = ESTB <Status byte lost>"
If (iberr = ESRQ) Then
  AddIberr = vbCrLf & "iberr = ESRQ <SRQ stuck high>"
If (iberr = ETAB) Then
  AddIberr = vbCrLf & "iberr = ETAB <Table overflow>"
Else
  AddIberr = vbCrLf & "iberr = " & Str$(iberr)
End If
End Function

Function AddIbsta() As String
' Return a GPIB interface error message string by examining the
' bits in the ibsta variable.
AddIbsta = vbCrLf & "ibsta = &H" & Hex$(ibsta) & " <"
If (ibsta And EERR) Then AddIbsta = AddIbsta & " ERR"
If (ibsta And TIMO) Then AddIbsta = AddIbsta & " TIMO"
If (ibsta And EEND) Then AddIbsta = AddIbsta & " END"
If (ibsta And SRQI) Then AddIbsta = AddIbsta & " SRQI"
If (ibsta And RQS) Then AddIbsta = AddIbsta & " RQS"
If (ibsta And CMPL) Then AddIbsta = AddIbsta & " CMPL"
If (ibsta And LOK) Then AddIbsta = AddIbsta & " LOK"
If (ibsta And RREM) Then AddIbsta = AddIbsta & " REM"
If (ibsta And CIC) Then AddIbsta = AddIbsta & " CIC"
If (ibsta And AATN) Then AddIbsta = AddIbsta & " ATN"
If (ibsta And TACS) Then AddIbsta = AddIbsta & " TACS"
If (ibsta And LACS) Then AddIbsta = AddIbsta & " LACS"
If (ibsta And DTAS) Then AddIbsta = AddIbsta & " DTAS"
If (ibsta And DCAS) Then AddIbsta = AddIbsta & " DCAS"
AddIbsta = AddIbsta & ">"
End Function

```



# 2. System Command Descriptions

This section describes the System commands, as listed in Section 1. IEEE Std 488.2 Common commands (preceded by an asterisk) are listed first, alphabetically, followed by the remaining system commands, alphabetically. Refer to Section 1 for a list of all commands by command groups, and for command notation and syntax.

---

## \* CLS

Clear Status command. Clears the Standard Event Status Register and the Status Byte Register.

**Related Commands:** \*ESR, \*STB

**Syntax:** \*CLS

**Example:** \*CLS

---

## \* ESE

Standard Event Status Enable command. Sets bits in the Standard Event Status Enable register to allow events or errors to set the event status bit (bit 5) in the Status Byte Register. The single integer decimal numeric argument may be a number in the range 0 to 255. Non-integer numbers will be rounded up or down to the nearest valid integer.

Bit	7	6	5	4	3	2	1	0
Event	PON	URQ	CME	EXE	DDE	QYE	RQC	OPC

*The Standard Event Status Enable register (SESE)*

**Related commands:** \*ESR, \*SRE, \*OPC

**Syntax:** \*ESE <nrf>

**Factory Default:** 0

**Example:** \*ESE 255;

---

## \* ESE?

Standard Event Status Enable Query command. Returns the value of the Event Status Enable register in decimal notation. Returns an integer in the range of 0 to 255.

**Related Commands:** \*ESR, \*SRE, \*OPC

**Syntax:** \*ESE?

**Example:** \*ESE?

**Response:** 255;

---

**\*ESR?**

Standard Event Status Register Query command. Returns the value of the Standard Event Status register in decimal notation and clears all bits in the register. A destructive read.

Bit	7	6	5	4	3	2	1	0
Event	PON	URQ	CME	EXE	DDE	QYE	RQC	OPC

*The Standard Event Status Register (SESR)*

**Related Commands:** \*ESE, \*SRE, \*OPC

**Syntax:** \*ESR?

**Example:** 128; indicates Bit 7, Power-On event, was set.

---

**\*IDN?**

Identification Query command. Returns the instrument identification string. The response is organized into four comma-separated fields:

- Field 1 Manufacturer (AUDIO PRECISION)
- Field 2 Instrument model (PORTABLE ONE PLUS ACCESS or PORTABLE ONE DUAL DOMAIN)
- Field 3 Not used (0)
- Field 4 Firmware level

The firmware field for the Portable One Dual Domain contains two firmware version numbers. The first number is the microprocessor firmware version. The second number is the digital signal processor firmware version.

**Related Commands:** None

**Syntax:** \*IDN?

**Example:** \*IDN?

**Access Response:** AUDIO PRECISION, PORTABLE ONE PLUS ACCESS, 0, 3.11;

**Dual Domain Response:** AUDIO PRECISION, PORTABLE ONE DUAL DOMAIN, 0, 3.11 1.00;

---

**\*LRN?**

Returns all settings for the instrument. All settings will be returned with command headers (i.e. implicit HEADER ON). The response settings may be sent back to the instrument unaltered to completely reset the instrument to that state. The response will always include the DISP GPIB command as the first message unit.

For the Portable One Plus Access (P1PA) this command is equivalent to sending the following query string:

```
:FORMAT?; :FUNCTION?; :GENERATOR?;
:GAMPLITUDE?; :GFREQUENCY?; :GZ?; :HEADER?; :IMDHF?;
:IMDLF?; :INPUT?; :LIGHT?; :OUTPUT?; :PRN?;
:REFDBM?; :REFDDB?; :REFWATT?; :RNGA?; :RNGB?; :RNGM?;
:SDELAY?; :SETTLE?; :SPOINTS?; :SRESOLUTION?;
:STIMEOUT?; :STOLERANCE?; :SWEEP?; :TRIGGER?;
:VERBOSE?; :WAVEFORM?; :ZINA?; :ZINB?; :ACMAINS:SET?;
:AMPLITUDE:SET?; :GENLOAD:SET?; :IMD:SET?;
:LEVEL:SET?; :NOISE:SET?; :PHASE:SET?; :RATIO:
SET?; :SINAD:SET?; :THD:SET?; :WF:SET?; :XTALK:SET?;
:DISPLAY?
```

For the Portable One Dual Domain (P1DD) this command is equivalent to sending the following query string:

```

:DCAL?;:DGAMPLITUDE?;DGFREQUENCY?;:DGRATE?;
:DGSQRFREQ?;:DIMHF?;:DIMLF?;DINPUT?;:DISPLAY?;
:DITHER?;:DOAMPLITUDE?;:DORESOLUTION?;:DOUTPUT?;
:DREFDBR?;:DRGA?;:DRGB?;:DHOLD?;:DSREF?;:DSYNCH?;
:DTRGOUT?;:DWAVEFORM?;:DZIN?;:FORMAT?;:FUNCTION?;
:GENERATOR?;:GAMPLITUDE?;:GFREQUENCY?;:GZ?;
:HEADER?;:IMDHF?;:IMDLF?;:INPUT?;:JAMPLITUDE?;
:JFREQUENCY?;:JWAVEFORM?;:LIGHT?;:OUTPUT?;:PRN?;
:REFDBM?;:REFDBR?;:REFWATT?;:RNGA?;:RNGB?;:RNGM?;
:SDELAY?;:SETTLE?;:SPOINTS?;:SRESOLUTION?;
:STIMEOUT?;:STOLERANCE?;:SWEEP?;:TRIGGER?;
:VERBOSE?;:WAVEFORM?;:ZINA?;:ZINB?;:ACMAINS:SET?;
:DAMPLITUDE:SET?;:DCHK:SET?;:DIMD:SET?;:DIO:SET?;
:DJITTER:SET?;:DLEVEL:SET?;:DNOISE:SET?;
:DSTATUS:SET?;:DPHASE:SET?;:DRATIO:SET?;
:DTHD:SET?;:DXTALK:SET?;:AMPLITUDE:SET?;
:GENLOAD:SET?;:IMD:SET?;:LEVEL:SET?;:NOISE:SET?;
:PHASE:SET?;:RATIO:SET?;:SINAD:SET?;:THD:SET?;
:WF:SET?;:XTALK:SET?;

```

**Group:** System

**Related Commands:** SET?

**Syntax:** \*LRN?

**Example:** \*LRN?

**NOTE:** The following responses have been formatted for readability. The actual responses will have different line lengths, and will not have the bold and spacing attributes shown here.

**Access Response:**

```

DISP GPIB;:FORMAT ASCII;:FUNCTION LEVEL;
:GAMPLITUDE 1. V;:GFREQUENCY 1.E+3 HZ;:GZ B40;
:HEADER ON;:IMDHF 7000.;:IMDLF 60.;:INPUT A;
:LIGHT ON;:OUTPUT OFF;:PRN IBM;:REFDBM 600. OHM;
:REFDBR 1. V;:REFWATT 8. OHM;:RNGA -0.1;
:RNGB -0.1;:RNGM 1.;:SDELAY 7.5E-2;:SETTLE OFF;
:SPOINTS 3;:SRESOLUTION 1.E-7;:STIMEOUT 5.;
:STOLERANCE 1.;:TRIGGER OFF;:VERBOSE ON;
:WAVEFORM SINE;:ZINA HIGH;:ZINB HIGH;
:ACMAINS:LUNIT PCT;MMAX 300. V;MMIN 0. V;UNIT V;
:AMPLITUDE:AMAX 1. V;AMIN 0. V;BPFR 1.E+3 HZ;
EXTERNAL GLIDE;FILTER UNWTD;FMAX 20.E+3 HZ;
FMIN 20. HZ;HPASS OFF;LPASS R300K;MMAX 10. V;
MMIN 1.E-6 V;SPEED FAST;STEPS 0;SWPTYPE FREQ;
UNIT V;WTD IECA;
:GENLOAD:FMAX 20.E+3 HZ;FMIN 20. HZ;
MMAX 1000. OHM;MMIN 0. OHM;SPEED FAST;STEPS 0;
UNIT OHM;
:IMD:AMAX 1. V;AMIN 0. V;LUNIT V;MMAX 1. PCT;
MMIN 0. PCT;SPEED FAST;STEPS 0;UNIT PCT;
:LEVEL:AMAX 1. V;AMIN 0. V;EXTERNAL GLIDE;
FMAX 20.E+3 HZ;FMIN 20. HZ;LUNIT V;MMAX 10. V;
MMIN 1.E-6 V;SPEED FAST;STEPS 0;SWPTYPE FREQ;
UNIT V;
:NOISE:AMAX 1. V;AMIN 0. V;BPFR 1.E+3 HZ;
EXTERNAL GLIDE;FILTER UNWTD;FMAX 20.E+3 HZ;
FMIN 20. HZ;HPASS OFF;LPASS R80K;MMAX 10. V;
MMIN 1.E-6 V;SPEED FAST;STEPS 0;SWPTYPE FREQ;
UNIT V;WTD IECA;
:PHASE:AMAX 1. V;AMIN 0. V;AVERAGE NOAVERAGE;
EXTERNAL GLIDE;FMAX 20.E+3 HZ;FMIN 20. HZ;
LUNIT V;MMAX 180. DEG;MMIN -180. DEG;
RANGE DEG270;SPEED FAST;STEPS 0;SWPTYPE FREQ;

```

```

UNIT DEG;
:RATIO:AMAX 1. V;AMIN 0. V;EXTERNAL GLIDE;
FMAX 20.E+3 HZ;FMIN 20. HZ;LUNIT V;MMAX 20. DB;
MMIN -60. DB;MODE 1;SPEED FAST;STEPS 0;
SWPTYPE FREQ;UNIT DB;
: SINAD:HPASS OFF;LPASS R30K;LUNIT V;MMAX 40. DB;
MMIN -140. DB;NOTCHFREQ 400. HZ;PRESET F400;
TUNE OFF;UNIT DB;
:THD:AMAX 1. V;AMIN 0. V;EXTERNAL GLIDE;
FILTER UNWTD;FMAX 20.E+3 HZ;FMIN 20. HZ;
HPASS OFF;LPASS R80K;LUNIT V;MMAX 1. PCT;
MMIN 0.0001 PCT;NOTCHFREQ 1.E+3 HZ;
SPEED FAST;STEPS 0;SWPTYPE FREQ;TUNE AUTO;
UNIT PCT;WTD RMSCCIR;
:WF:DETECT IEC;FILTER WTD;LUNIT V;MMAX 1. PCT;
MMIN 0. PCT;RESPONSE PEAK;UNIT PCT;WFUNIT HZ;
:XTALK:AMAX 1. V;AMIN 0. V;EXTERNAL GLIDE;
FMAX 20.E+3 HZ;FMIN 20. HZ;LUNIT V;MMAX 0. DB;
MMIN -120. DB;SPEED FAST;STEPS 0;SWPTYPE FREQ;
UNIT DB;
:DISPLAY PANEL;

```

**Dual Domain Response:**

```

DISP GPIB;;DCAL BAL;;DGAMPLITUDE 0. DBFS;
: DGFREQUENCY 997. HZ;;DGRATE 48000. HZ;
: DGSQRFREQ 1000. HZ;;DHOLD OFF;;DIMHF 7000.;
: DIMLF 60.;;DINPUT A;;DITHER TRI;
: DOAMPLITUDE 5. VPP;;DORESOLUTION 24;
: DOUTPUT OFF;;DREFDDB 1. FFS;;DRGA 0.;;DRGB 0.;
: DSREF OFF;;DSYNCH 0.;;DTRGOUT XMTFRAME;
: DWAVEFORM SINE;;DZIN HIGH;;FORMAT ASCII;
: FUNCTION LEVEL;;GAMPLITUDE 1. V;
: GENERATOR ANLG;;GFREQUENCY 1.E+3 HZ;;GZ B40;
: HEADER ON;;IMDHF 7000.;;IMDLF 60.;;INPUT A;
: JAMPL 0. UI;;JFREQ 1.002E+3 HZ;;JWAVE OFF;
: LIGHT ON;;OUTPUT OFF;;PRN IBM;;REFDBM 600. OHM;
: REFDBR 1. V;;REFWATT 8. OHM;;RNGA -0.1;
: RNGB -0.1;;RNGM 1.;;SDELAY 7.5E-2;;SETTLE OFF;
: SPOINTS 3;;SRESOLUTION 1.E-7;;STIMEOUT 5.;
: STOLERANCE 1.;;TRIGGER OFF;;VERBOSE ON;
: WAVEFORM SINE;;ZINA HIGH;;ZINB HIGH;
: ACMAINS:LUNIT PCT;MMAX 300. V;MMIN 0. V;UNIT V;
: AMPLITUDE:AMAX 1. V;AMIN 0. V;BPFR 1.E+3 HZ;
EXTERNAL GLIDE;FILTER UNWTD;FMAX 20.E+3 HZ;
FMIN 20. HZ;HPASS OFF;LPASS R300K;MMAX 10. V;
MMIN 1.E-6 V;SPEED FAST;STEPS 0;SWPTYPE FREQ;
UNIT V;WTD IECA;
: GENLOAD:FMAX 20.E+3 HZ;FMIN 20. HZ;
MMAX 1000. OHM;MMIN 0. OHM;SPEED FAST;STEPS 0;
UNIT OHM;
: IMD:AMAX 1. V;AMIN 0. V;LUNIT V;MMAX 1. PCT;
MMIN 0. PCT;SPEED FAST;STEPS 0;UNIT PCT;
: LEVEL:AMAX 1. V;AMIN 0. V;EXTERNAL GLIDE;
FMAX 20.E+3 HZ;FMIN 20. HZ;LUNIT V;MMAX 10. V;
MMIN 1.E-6 V;SPEED FAST;STEPS 0;SWPTYPE FREQ;
UNIT V;
: NOISE:AMAX 1. V;AMIN 0. V;BPFR 1.E+3 HZ;
EXTERNAL GLIDE;FILTER UNWTD;FMAX 20.E+3 HZ;
FMIN 20. HZ;HPASS OFF;LPASS R80K;MMAX 10. V;
MMIN 1.E-6 V;SPEED FAST;STEPS 0;SWPTYPE FREQ;
UNIT V;WTD IECA;
: PHASE:AMAX 1. V;AMIN 0. V;AVERAGE NOAVERAGE;
EXTERNAL GLIDE;FMAX 20.E+3 HZ;FMIN 20. HZ;
LUNIT V;MMAX 180. DEG;MMIN -180. DEG;

```

```

RANGE DEG270;SPEED FAST;STEPS 0;SWPTYPE FREQ;
UNIT DEG;
:RATIO:AMAX 1. V;AMIN 0. V;EXTERNAL GLIDE;
FMAX 20.E+3 HZ;FMIN 20. HZ;LUNIT V;MMAX 20. DB;
MMIN -60. DB;MODE 1;SPEED FAST;STEPS 0;
SWPTYPE FREQ;UNIT DB;
:SINAD:HPASS OFF;LPASS R30K;LUNIT V;MMAX 40. DB;
MMIN -140. DB;NOTCHFREQ 400. HZ;PRESET F400;
TUNE OFF;UNIT DB;
:THD:AMAX 1. V;AMIN 0. V;EXTERNAL GLIDE;
FILTER UNWTD;FMAX 20.E+3 HZ;FMIN 20. HZ;
HPASS OFF;LPASS R80K;LUNIT V;MMAX 1. PCT;
MMIN 0.0001 PCT;NOTCHFREQ 1.E+3 HZ;SPEED FAST;
STEPS 0;SWPTYPE FREQ;TUNE AUTO;UNIT PCT;
WTD RMSCCIR;
:WF:DETECT IEC;FILTER WTD;LUNIT V;MMAX 1. PCT;
MMIN 0. PCT;RESPONSE PEAK;UNIT PCT;WFUNIT HZ;
:XTALK:AMAX 1. V;AMIN 0. V;EXTERNAL GLIDE;
FMAX 20.E+3 HZ;FMIN 20. HZ;LUNIT V;MMAX 0. DB;
MMIN -120. DB;SPEED FAST;STEPS 0;SWPTYPE FREQ;
UNIT DB;
:DAMPL:AMAX 1. V;AMIN 0. V;BPFR 1.E+3 HZ;
EXTERNAL GLIDE;FILTER UNWTD;FMAX 20.E+3 HZ;
FMIN 20. HZ;HPASS HP10;LPASS HALFRATE;
MMAX 0. DBFS;MMIN -120. DBFS;SPEED FAST;STEPS 0;
SWPTYPE FREQ;UNIT DBFS;WTD IECA;
:DCHK:DBITS ACTV;DUNIT HEX;MMAX 1000 NORM;
MMIN 0 NORM;UNIT NORM;
:DIMD:AMAX 1. V;AMIN 0. V;LUNIT DBFS;
MMAX -40. DB;MMIN -999. DB;SPEED FAST;STEPS 0;
UNIT DB;
:DIO:DDREF OUTF;DIRESOLUTION 0.;DUNIT SEC;
FRQREF MEAS;MMAX 50000. HZ;MMIN 30000. HZ;
UNIT HZ;
:DJITTER:AMAX 1. V;AMIN 0. V;BPFR 1.E+3 HZ;
EXTERNAL GLIDE;FILTER UNWTD;FMAX 20.E+3 HZ;
FMIN 20. HZ;HPASS HP50;JDETECTOR RMS;LUNIT VPP;
MMAX 1. UI;MMIN 0. UI;SPEED FAST;STEPS 0;
SWPTYPE FREQ;UNIT UI;
:DLEVEL:AMAX 1. V;AMIN 0. V;EXTERNAL GLIDE;
FMAX 20.E+3 HZ;FMIN 20. HZ;LUNIT DBFS;
MMAX 0. DBFS;MMIN -120. DBFS;SPEED FAST;STEPS 0;
SWPTYPE FREQ;UNIT DBFS;
:DNOISE:AMAX 1. V;AMIN 0. V;BPFR 1.E+3 HZ;
EXTERNAL GLIDE;FILTER UNWTD;FMAX 20.E+3 HZ;
FMIN 20. HZ;HPASS HP10;LPASS HALFRATE;
MMAX 0. DBFS;MMIN -120. DBFS;SPEED FAST;STEPS 0;
SWPTYPE FREQ;UNIT DBFS;WTD IECA;
:DOSTATUS:STDO PROF;
PROF AUTO,NI,NULL,NULL;VALIDITY VALID;
:DPHASE:AMAX 1. V;AMIN 0. V;EXTERNAL GLIDE;
FMAX 20.E+3 HZ;FMIN 20. HZ;LUNIT DBFS;
MMAX 180. DEG;MMIN -180. DEG;RANGE DEG270;
SPEED FAST;STEPS 0;SWPTYPE FREQ;UNIT DEG;
:DRATIO:AMAX 1. V;AMIN 0. V;EXTERNAL GLIDE;
FMAX 20.E+3 HZ;FMIN 20. HZ;LUNIT DBFS;
MMAX 20. DB;MMIN -60. DB;SPEED FAST;STEPS 0;
SWPTYPE FREQ;UNIT DB;
:DTHD:AMAX 1. V;AMIN 0. V;EXTERNAL GLIDE;
FILTER UNWTD;FMAX 20.E+3 HZ;FMIN 20. HZ;
HPASS HP10;LPASS HALFRATE;LUNIT DBFS;
MMAX -40. DB;MMIN -120. DB;NOTCHFREQ 1.E+3 HZ;
SPEED FAST;STEPS 0;SWPTYPE FREQ;TUNE AUTO;
UNIT DB;WTD IECA;

```

```
:DXTALK:AMAX 1. V;AMIN 0. V;EXTERNAL GLIDE;
FMAX 20.E+3 HZ;FMIN 20. HZ;LUNIT DBFS;
MMAX 0. DB;MMIN -120. DB;SPEED FAST;STEPS 0;
SWPTYPE FREQ;UNIT DB;
:DISPLAY PANEL;
```

---

## \* OPC

Operation Complete command. Provides a means of synchronizing the instrument with the controller. Sets the OPC bit (bit 0) in the Standard Event Status Register.

**Related Commands:** \*ESE, \*SRE

**Syntax:** \*OPC

**Example:** \*OPC

---

## \* OPC?

Operation Complete Query command. Places a 1 in the output queue to provides a means of synchronizing the instrument with the controller.

**Related Commands:** \*SRE

**Syntax:** \*OPC?

**Example:** \*OPC?

**Response:** 1;

---

## \* OPT?

Option Identification Query command. Identifies the presence of instrument options. Options are AUX1, AUX2, EURO, IMD, and 96K.

The response is in the form *AUX1, AUX2, EURO, IMD, 96K* where five fields are always present. The first field is AUX1 if a filter is installed in the first optional filter slot or 0 if the AUX1 filter is not installed. The second field is AUX2 if a filter is installed in the second optional filter slot or 0 if the AUX2 filter is not installed. The third field is EURO if this analog generator output impedance option is installed or 0 if the EURO option is not installed. The fourth field is IMD if the IMD generator and analyzer option is installed or 0 if the IMD option is not installed. The fifth field is 96K if the 96 K sample rate option is installed or 0 if this option is not installed. The fifth field applies only to the dual domain instrument.

**Related Commands:** None

**Syntax:** \*OPT?

**Example:** \*OPT?

**Response:** 0, 0, 0, 0, 0; with no options installed

AUX1, AUX2, 0, IMD, 96K; with AUX1, AUX2, IMD, and 96K options installed.

---

**\*RCL**

The \*RCL command sets the instrument to the settings saved in the specified register number. The argument specifies the register number. The range of allowable register numbers is 0 to 29. The register number argument may be any numeric format and will be rounded to an integer. An error will be generated if a setting register is empty (contains no saved settings).

**Related Commands:** \*SAV

**Syntax:** \*RCL <nrf>

**Example:** \*RCL 10

---

**\*RST**

The \*RST command resets the instrument to the factory default settings. See appendix B for the factory default settings. The GPIB address remains unchanged. \*RST does not clear the contents of the standard event status register or the status byte register. \*RST does not change saved settings and does not set the following instrument settings: DELAY, LIGHT.

**Related Commands:** \*CLS

**Syntax:** \*RST

**Example:** \*RST

---

**\*SAV**

The \*SAV command specifies a register number for saving the current instrument settings and sweep data. The range of allowable register numbers is 0 to 29. The register number argument may be any numeric format and will be rounded to an integer. Settings already stored in a settings register will be deleted unless the register is protected by the PROTECT command. An execution error will be reported if the specified register is in protect mode.

The name of the setting will be defaulted to the name of the current measurement function and related data. The current date and time will be stored within the default name. The name may be subsequently changed with the NAME command. The status of saved settings is not returned in the response to \*LRN? or SET?.

**Related Commands:** \*RCL, NAME, PROTECT

**Syntax:** \*SAV <nrf>

**Example:** \*SAV 10

**\*SRE**

Service Request Enable command. Enables service request interrupts for Message Available (MAV) and Standard Event Summary Message (ESB). The argument may be integer numbers in the range of 0 to 255. Non-integer arguments will be rounded to the nearest integer.

Bit	7	6	5	4	3	2	1	0
Event	—	—	ESB	MAV	—	—	—	—

*The Service Request Enable Register (SRER).*

**Related Commands:** \*STB?, \*ESR?, \*ESE, \*ESE?

**Syntax:** \*SRE <nrf>

**Factory Default:** 0

**Example:** \*SRE 255

**\*SRE?**

Service Request Enable Query command. Returns the value of the service request enable register in decimal notation. Responses will be integer numbers in the range of 0 to 255.

**Related Commands:** \*STB?, \*ESR?, \*ESE, \*ESE?

**Syntax:** \*SRE?

**Example:** \*SRE?

**Response:** 0;

**\*STB?**

Read Status Byte Query command. Returns the value of the status byte register in decimal notation. Responses will be integer numbers in the range of 0 to 255.

Bit	7	6	5	4	3	2	1	0
Event	—	RQS	ESB	MAV	—	—	—	—
		MSS						

*The Status Byte Register (SBR).*

**Group:** Measurement

**Related Commands:** \*SRE, \*ESE, \*ESR?

**Syntax:** \*STB?

**Example:** \*STB?

**Response:** 0;

**\*TRG**

Trigger Command. Initiates the same action as a Group Execute Trigger (GET) bus command. Initiates a triggered measurement if the instrument is in the triggered measurement mode (TRIGGER ON command has been sent previously), otherwise is ignored.

**Related Commands:** TRIGger

**Syntax:** \*TRG

**Example:** \*TRG

---

**\*TST?**

Self-test Query command. This executes the self-test function in the AC Mains display menu. The response will be an integer, 0 if the selftest passed with no failures, otherwise a 3-digit code for the first test which failed.

The 3-digit failure code is related to the self test codes as follows: xxy for test x.xy where the value of y is 2 if the test has a B suffix, 1 if the test has an A suffix, and 0 if the test has no suffix. Example: test 7.0A fails so the code returned by the \*TST? command would be 701.

A self test may be aborted with the SDC (Select Device Clear) or DCL (Device Clear) GPIB bus commands.

**Related Commands:** TEST

**Syntax:** \*TST?

**Example** \*TST?

**Response** With no errors: 0;  
With at least one error: 701;

**NOTE:** The analog and digital generator outputs must be disconnected from any load before issuing the \*TST? Command; otherwise, the test may fail or damaging voltages may be applied to the device under test. Commands sent while the self-test is running may interfere with the test and cause test errors.

---

**\*WAI**

Wait-to-Continue command. Forces sequential execution of commands in the input queue. Use this command after a SWEEP START or \*TST? command to force subsequent commands and queries to be held off until the sweep or self-test is done.

**Related Commands:** None

**Syntax:** \*WAI

**Example:** \*WAI

---

**CLROutbuf**

Clears the instrument output buffer (output queue) of any unread query responses and sets the MAV bit to 0 in the Status Byte Register. Use the CLROUTBUF command as an alternative to the SDC or DCL GPIB bus commands to clear the output buffer.

**Related Commands:** DCL or SDC GPIB bus commands.

**Syntax:** CLROutbuf

**Example:** CLROUTBUF

---

**CLRTime**

Resets the internal timer to 0 seconds, the initial value set when the instrument is turned on. This is used with the TIME? command when the elapsed time between events is desired.

**Related Commands:** TIME?

**Syntax:** CLRTime

**Example:** CLRTIME

---

## DATE

Sets the current calendar date. Three numeric arguments specify the year, month, and day in the format yy,mm,dd. Each argument takes two digits maximum; it is not necessary to enter the leading zero.

The example shows the date for April 1, 1998.

**Related Commands:** DATE?; DTIME  
**Syntax:** DATE <nr1>,<nr1>,<nr1>  
**Example:** DATE 98,04,01;

---

## DATE?

Returns the current calendar date in the format yy,mm,dd.

**Related Commands:** DATE  
**Syntax:** DATE?  
**Example:** DATE?  
**Response:** :DATE 98,04,01;

---

## DElay

Initiates a programmed delay in seconds. The instrument stops all processing for the delay time specified by the numeric argument. Subsequent queries and set commands are held off until the specified time elapses. The status byte register may be read with a serial poll during the delay interval. Interleaving the DELAY command between them may pace the execution of commands sent to the instrument.

**Related Commands:** None  
**Syntax:** DELay <nrf>  
**Example:** DELAY 2.5

---

## DElete

Deletes or undeletes a saved instrument settings register. The numeric argument specifies the numbered saved setting register (range 0 to 29). The second argument specifies the condition: ON means the register is deleted, OFF means the register is undeleted. A register that is protected from \*SAV with the PROTect command may be deleted with the DElete command. A register that has been deleted is given the new name of "deleted \_ \_ \_ \_ \_" (seven-character name with seven trailing space characters). A register that has been undeleted reverts to its prior saved settings condition and setting name.

**Related Commands:** PROTect, \*SAV, \*RCL, NAME  
**Syntax:** DElete <nr1>, {OFF | ON}  
**Example:** DELETE 1, ON

---

## DELeTe?

Returns the delete status of the specified saved setting register. The numeric argument specifies the saved setting register (range 0 to 29). See the DELeTe command description above for more information.

**Related Commands:** DELeTe  
**Syntax:** DELeTe? <nr1>  
**Example:** DELETE? 1  
**Response:** DELETE 1, ON;

---

## DISPlay

Controls the front panel display mode for the currently selected measurement function. ANALYZER displays only the analyzer readings and settings. BARGraph turns on the normal bargraph display. DSTATus turns on the digital interface status bits panel for the Dual Domain instrument only and generates an illegal argument error for the Access instrument. GENERATOR turns on the generator display only. GPIB turns on the GPIB address display. PANel turns on the normal analyzer/generator display with readings. SWEEP turns on the sweep display. TEST turns on the self test display. UTILity turns on the utility panel which contains the controls for the printer type, date and time, amplitude and frequency step size, invert display, and digital trigger out options. SETUPS turns on the RECALL/SAVE display.

**Note:** The MMIN and MMAX commands with units arguments will change the bargraph or sweep displayed units only if the DISPLAY command is set to BARGRAPH or SWEEP.

**Group:** System  
**Related Commands:** MMIN, MMAX  
**Access Syntax:** DISPlay { ANALyzer | BARGraph | GENerator | GPIB | PANel | SWEep | TEST | UTILity | SETUPS }  
**Dual Domain Syntax:** DISPlay { ANALyzer | BARGraph | DSTATus | GENerator | GPIB | PANel | SWEep | TEST | UTILity | SETUPS }  
**Factory Default:** PANel  
**Example:** DISPLAY PANEL

---

## DISPlay?

Returns the currently selected front panel display.

**Related Commands:** None  
**Syntax:** DISPlay?  
**Example:** DISPLAY?  
**Response:** :DISPLAY PANEL;

---

## DTIME

Sets the current time in 24 hour format. Three numeric arguments specify the hour, minute, and second in the format hh,mm,ss.

The example shows the time for 10:05:33 PM.

**Related Commands:** DTIME?; DATE

**Syntax:** DTIME <nr1>,<nr1>,<nr1>

**Example:** DTIME 22,05,33

---

## DTIME?

Returns the current hour, minute, and second time in the format hh,mm,ss.

**Related Commands:** DTIME

**Syntax:** DTIME?

**Example:** DTIME?

**Response:** :DTIME 22,05,33;

---

## DTRGout

**Dual Domain only**

Selects the current digital trigger signal provided at the Digital Trigger output BNC connector on the rear panel.

The argument choices are:

- Digital Signal Generator (DGEN) – squarewave at digital generator audio frequency,
- Jitter Generator (JITGEN) – squarewave at jitter frequency,
- Receive Clock (RCVCLK) – squarewave at 256 x the receive sample rate,
- Receive Error (RCVERR) – logic low during Receive Error Detection,
- Receive Frame Synch (RCVFRAME) – squarewave at the receive sample rate,
- Reference Input Frame (REFFRAME) - one squarewave cycle per data frame (sample),
- Transmit Clock (XMTCLK) – squarewave at 256X the transmit sample rate,
- Transmit Frame Synch (XMTFRAME) – squarewave at the transmit sample rate.

**Group:** System

**Related Commands:** DTRGout?

**Factory Default:** DGEN

**Syntax:** DTRGout { DGEN | JITGen | RCVClk | RCVERR | RCVFrame | REFFrame | XMTClk | XMTFrame }

**Example:** DTRGOUT DGEN

---

## DTRGout?

**Dual Domain only**

Returns the current digital trigger signal provided at the Digital Trigger output BNC connector on the rear panel.

**Group:** System

**Related Commands:** DTRGout

**Syntax:** DTRGout?

**Example:** DTRGOUT?

**Response:** :DTRGOUT DGEN;

---

## ERRMessage?

Returns the most recent error message string. Command argument errors result in a message containing the valid arguments.

**Related Commands:** \*ESR?, \*STB?

**Syntax:** ERRMessage?

**Example:** HEADER XYZ;ERRMESSAGE?

**Response:** :ERRMESSAGE 2, "INVALID COMMAND ARGUMENT FOR  
:HEADER, VALID ARGUMENTS ARE: OFF,ON";

---

## GENerator

**Dual Domain only**

Selects the generator that should be displayed or swept when the DISPLAY command selects either GENERATOR or PANel. Selects the generator that will be swept when a sweep is started. The generator to be selected may be the analog generator ANLG, the digital generator DIG, the digital interface jitter generator JITT, or the digital interface rate generator RATE. Note that the sample rate cannot be swept on the digital interface rate generator.

**Group:** System Commands

**Related Commands:** GENerator?, SWPType, DISPLAY, SWEEP

**Syntax:** GENerator { ANLG | DIG | JITT | RATE }

**Factory Default:** ANLG

**Example:** GENERATOR DIG

---

## GENerator?

**Dual Domain only**

Returns the current generator which will be displayed or swept when the DISPLAY command selects either GENERATOR or PANel. The response may be the analog generator ANLG, the digital generator DIG, the digital interface jitter generator JITT, or the digital interface rate generator RATE.

**Group:** System Commands

**Related Commands:** GENerator, SWPType, DISPLAY, SWEEP

**Syntax:** GENerator?

**Example:** GENERATOR?

**Response:** :GENERATOR DIG;

---

## HEADer

Enables or disables sending headers in query responses. The query responses are sent without headers if OFF.

**Related Commands:** None

**Syntax:** HEADer { ON | OFF }

**Factory Default:** ON.

**Example:** HEADER ON

---

## HEADER?

Returns the current header command setting, ON or OFF.

**Related Commands:** None

**Syntax:** HEADER?

**Example:** HEADER?

**Response:** :HEADER ON;

---

## HELP?

Returns a list of all commands and measurement queries for the instrument, but does not list query forms of settings commands. The list is arranged alphabetically in the following order: IEEE-488.2 Common Commands, root node commands, function commands, and function parameters. If VERBOSE ON is in effect, each group of commands is delimited with a carriage return character to improve readability. If VERBOSE OFF is in effect, no carriage return characters are used to delimit each group of commands. Examples of both modes are shown below.

**Group:** System

**Related Commands:** VERBOSE

**Syntax:** HELP?

**Example:** VERBOSE ON;HELP?

**NOTE:** The following responses have been formatted for readability. The actual responses will have different line lengths, and will not have the bold and spacing attributes shown here.

**Access Response:**

```
:HELP
*CLS;*ESE;*ESR;*IDN;*LRN;*OPC;*OPT;*RCL;*RST;*SAV;
*SRE;*STB;*TRG;*TST;*WAI;:CLROUTBUF;:CLRTIME;
:DATA1;:DATA2;:DATAA;:DATAF;:DATE;:DBRZERO;:DELAY;
:DELETE;:DISPLAY;:DTIME;:ERRMESSAGE;:FORMAT;
:FUNCTION;:GAMPLITUDE;:GFREQUENCY;:GZ;:HEADER;
:HELP;:HOLD;:IMDHF;:IMDLF;:INPUT;:LIGHT;:M1;:M2;
:M3;:MF;:MP;:NAME;:OUTPUT;:PRINT;:PRN;:PROTECT;
:REFDBM;:REFDBR;:REFWATT;:REPEAT;:RNGA;:RNGB;
:RNGM;:SDELAY;:SETTLE;:SPOINTS;:SRESOLUTION;
:STIMEOUT;:STOLERANCE;:SWEEP;:TEST;:TIME;:TRIGGER;
:VERBOSE;:WAVEFORM;:ZINA;:ZINB;
:ACMAINS:LUNIT;MMAX;MMIN;SET;UNIT;
:AMPLITUDE:AMAX;AMIN;BPFR;EXTERNAL;FILTER;FMAX;
FMIN;HPASS;LPASS;MMAX;MMIN;SET;SPEED;STEPS;
SWPTYPE;UNIT;WTD;
:GENLOAD:FMAX;FMIN;MMAX;MMIN;SET;SPEED;STEPS;UNIT;
:IMD:AMAX;AMIN;LUNIT;MMAX;MMIN;SET;SPEED;STEPS;
UNIT;
```

**:LEVEL**: AMAX; AMIN; EXTERNAL; FMAX; FMIN; LUNIT; MMAX;  
 MMIN; SET; SPEED; STEPS; SWPTYPE; UNIT;  
**:NOISE**: AMAX; AMIN; BPFR; EXTERNAL; FILTER; FMAX; FMIN;  
 HPASS; LPASS; MMAX; MMIN; SET; SPEED; STEPS; SWPTYPE;  
 UNIT; WTD;  
**:PHASE**: AMAX; AMIN; AVERAGE; EXTERNAL; FMAX; FMIN; LUNIT;  
 MMAX; MMIN; RANGE; SET; SPEED; STEPS; SWPTYPE; UNIT;  
**:RATIO**: AMAX; AMIN; EXTERNAL; FMAX; FMIN; LUNIT; MMAX;  
 MMIN; MODE; SET; SPEED; STEPS; SWPTYPE; UNIT;  
**:SINAD**: HPASS; LPASS; LUNIT; MMAX; MMIN; NOTCHFREQ;  
 PRESET; SET; TUNE; UNIT;  
**:THD**: AMAX; AMIN; EXTERNAL; FILTER; FMAX; FMIN; HPASS;  
 LPASS; LUNIT; MMAX; MMIN; NOTCHFREQ; SET; SPEED; STEPS;  
 SWPTYPE; TUNE; UNIT; WTD;  
**:WF**: DETECT; FILTER; LUNIT; MMAX; MMIN; RESPONSE; SET;  
 UNIT; WFUNIT;  
**:XTALK**: AMAX; AMIN; EXTERNAL; FMAX; FMIN; LUNIT; MMAX;  
 MMIN; SET; SPEED; STEPS; SWPTYPE; UNIT;

### **Dual Domain Response:**

:HELP \*CLS;\*ESE;\*ESR;\*IDN;\*LRN;\*OPC;\*OPT;\*RCL;  
 \*RST;\*SAV;\*SRE;\*STB;\*TRG;\*TST;\*WAI;:CLROUTBUF;  
 :CLRTIME;:DATA1;:DATA2;:DATAA;:DATAF;:DATE;  
 :DBRZERO;:DCAL;:DELAY;:DELETE;:DGAMPLITUDE;  
 :DGFREQUENCY;:DGRATE;:DGSQRFREQ;:DHOLD;:DIMHF;  
 :DIMLF;:DINPUT;:DISPLAY;:DITHER;:DOAMPLITUDE;  
 :DORESOLUTION;:DOUTPUT;:DREFDBR;:DRGA;:DRGB;  
 :DSREF;:DSYNCH;:DTIME;:DTRGOUT;:DWAVEFORM;:DZIN;  
 :ERRMESSAGE;:FORMAT;:FUNCTION;:GAMPLITUDE;  
 :GENERATOR;:GFREQUENCY;:GZ;:HEADER;:HELP;:HOLD;  
 :IMDHF;:IMDLF;:INPUT;:JAMPL;:JFREQ;:JWAVE;:LIGHT;  
 :M1;:M2;:M3;:MF;:MP;:NAME;:OUTPUT;:PRINT;:PRN;  
 :PROTECT;:REFDBM;:REFDBR;:REFWATT;:REPEAT;:RNGA;  
 :RNGB;:RNGM;:SDELAY;:SETTLE;:SPOINTS;:SRESOLUTION;  
 :STIMEOUT;:STOLERANCE;:SWEEP;:TEST;:TIME;:TRIGGER;  
 :VERBOSE;:WAVEFORM;:ZINA;:ZINB;  
**:ACMAINS**: LUNIT; MMAX; MMIN; SET; UNIT;  
**:AMPLITUDE**: AMAX; AMIN; BPFR; EXTERNAL; FILTER; FMAX;  
 FMIN; HPASS; LPASS; MMAX; MMIN; SET; SPEED; STEPS;  
 SWPTYPE; UNIT; WTD;  
**:GENLOAD**: FMAX; FMIN; MMAX; MMIN; SET; SPEED; STEPS; UNIT;  
**:IMD**: AMAX; AMIN; LUNIT; MMAX; MMIN; SET; SPEED; STEPS;  
 UNIT;  
**:LEVEL**: AMAX; AMIN; EXTERNAL; FMAX; FMIN; LUNIT; MMAX;  
 MMIN; SET; SPEED; STEPS; SWPTYPE; UNIT;  
**:NOISE**: AMAX; AMIN; BPFR; EXTERNAL; FILTER; FMAX; FMIN;  
 HPASS; LPASS; MMAX; MMIN; SET; SPEED; STEPS; SWPTYPE;  
 UNIT; WTD;  
**:PHASE**: AMAX; AMIN; AVERAGE; EXTERNAL; FMAX; FMIN; LUNIT;  
 MMAX; MMIN; RANGE; SET; SPEED; STEPS; SWPTYPE; UNIT;  
**:RATIO**: AMAX; AMIN; EXTERNAL; FMAX; FMIN; LUNIT; MMAX;  
 MMIN; MODE; SET; SPEED; STEPS; SWPTYPE; UNIT;  
**:SINAD**: HPASS; LPASS; LUNIT; MMAX; MMIN; NOTCHFREQ;  
 PRESET; SET; TUNE; UNIT;  
**:THD**: AMAX; AMIN; EXTERNAL; FILTER; FMAX; FMIN; HPASS;  
 LPASS; LUNIT; MMAX; MMIN; NOTCHFREQ; SET; SPEED; STEPS;  
 SWPTYPE; TUNE; UNIT; WTD;  
**:WF**: DETECT; FILTER; LUNIT; MMAX; MMIN; RESPONSE; SET;  
 UNIT; WFUNIT;  
**:XTALK**: AMAX; AMIN; EXTERNAL; FMAX; FMIN; LUNIT; MMAX;  
 MMIN; SET; SPEED; STEPS; SWPTYPE; UNIT;  
**:DAMPL**: AMAX; AMIN; BPFR; EXTERNAL; FILTER; FMAX; FMIN;

```

HPASS;LPASS;MMAX;MMIN;SET;SPEED;STEPS;SWPTYPE;
UNIT;WTD;
:DCHK:BITS;DBITS;DUNIT;MMAX;MMIN;SET;UNIT;
:DIMD:AMAX;AMIN;LUNIT;MMAX;MMIN;SET;SPEED;STEPS;
UNIT;
:DIO:DDREF;DIRESOLUTION;DUNIT;FRQREF;MMAX;MMIN;
SET;UNIT;
:DISTATUS:CODING;CONFIDENCE;DISTATUS;ERROR;
INVALID;LOCK;PARITY;STATUS;STDI;
:DJITTER:AMAX;AMIN;BPFR;EXTERNAL;FILTER;FMAX;FMIN;
HPASS;JDETECTOR;LUNIT;MMAX;MMIN;SET;SPEED;STEPS;
SWPTYPE;UNIT;
:DLEVEL:AMAX;AMIN;EXTERNAL;FMAX;FMIN;LUNIT;MMAX;
MMIN;SET;SPEED;STEPS;SWPTYPE;UNIT;
:DNOISE:AMAX;AMIN;BPFR;EXTERNAL;FILTER;FMAX;FMIN;
HPASS;LPASS;MMAX;MMIN;SET;SPEED;STEPS;SWPTYPE;
UNIT;WTD;
:DOSTATUS:CONS;DOSTATUS;PROF;STDO;VALIDITY;
:DPHASE:AMAX;AMIN;EXTERNAL;FMAX;FMIN;LUNIT;MMAX;
MMIN;RANGE;SET;SPEED;STEPS;SWPTYPE;UNIT;
:DRATIO:AMAX;AMIN;EXTERNAL;FMAX;FMIN;LUNIT;MMAX;
MMIN;SET;SPEED;STEPS;SWPTYPE;UNIT;
:DTHD:AMAX;AMIN;EXTERNAL;FILTER;FMAX;FMIN;HPASS;
LPASS;LUNIT;MMAX;MMIN;NOTCHFREQ;SET;SPEED;STEPS;
SWPTYPE;TUNE;UNIT;WTD;
:DXTALK:AMAX;AMIN;EXTERNAL;FMAX;FMIN;LUNIT;MMAX;
MMIN;SET;SPEED;STEPS;SWPTYPE;UNIT;

```

**Example:** VERBOSE OFF;HELP?

**Access Response:**

```

:HELP *CLS;*ESE;*ESR;*IDN;*LRN;*OPC;*OPT;*RCL;
*RST;*SAV;*SRE;*STB;*TRG;*TST;*WAI;:CLRO;:CLRT;
:DATA1;:DATA2;:DATAA;:DATAF;:DATE;:DBRZ;:DEL;
:DELE;:DISP;:DTIM;:ERRM;:FORM;:FUNC;:GAMP;:GFRE;
:GZ;:HEAD;:HELP;:HOLD;:IMDH;:IMDL;:INP;:LIGH;
:M1;:M2;:M3;:MF;:MP;:NAME;:OUTP;:PRIN;:PRN;
:PROT;:REFDBM;:REFDBR;:REFW;:REP;:RNGA;:RNGB;
:RNGM;:SDEL;:SETT;:SPO;:SRES;:STIM;:STOL;:SWE;
:TEST;:TIME;:TRIG;:VERB;:WAV;:ZINA;:ZINB;
:ACM:LUN;MMAX;MMIN;SET;UNIT;
:AMPL:AMAX;AMIN;BPFR;EXT;FILT;FMAX;FMIN;HPAS;
LPAS;MMAX;MMIN;SET;SPE;STEP;SWPT;UNIT;WTD;
:GENL:FMAX;FMIN;MMAX;MMIN;SET;SPE;STEP;UNIT;
:IMD:AMAX;AMIN;LUN;MMAX;MMIN;SET;SPE;STEP;UNIT;
:LEV:AMAX;AMIN;EXT;FMAX;FMIN;LUN;MMAX;MMIN;SET;
SPE;STEP;SWPT;UNIT;
:NOIS:AMAX;AMIN;BPFR;EXT;FILT;FMAX;FMIN;HPAS;
LPAS;MMAX;MMIN;SET;SPE;STEP;SWPT;UNIT;WTD;
:PHAS:AMAX;AMIN;AVER;EXT;FMAX;FMIN;LUN;MMAX;
MMIN;RANG;SET;SPE;STEP;SWPT;UNIT;
:RAT:AMAX;AMIN;EXT;FMAX;FMIN;LUN;MMAX;MMIN;MODE;
SET;SPE;STEP;SWPT;UNIT;
:SIN:HPAS;LPAS;LUN;MMAX;MMIN;NOTC;PRES;SET;TUN;
UNIT;
:THD:AMAX;AMIN;EXT;FILT;FMAX;FMIN;HPAS;LPAS;LUN;
MMAX;MMIN;NOTC;SET;SPE;STEP;SWPT;TUN;UNIT;WTD;
:WF:DET;FILT;LUN;MMAX;MMIN;RESP;SET;UNIT;WFUN;
:XTAL:AMAX;AMIN;EXT;FMAX;FMIN;LUN;MMAX;MMIN;SET;
SPE;STEP;SWPT;UNIT;

```

**Dual Domain Response:**

```

:HELP *CLS;*ESE;*ESR;*IDN;*LRN;*OPC;*OPT;*RCL;
*RST;*SAV;*SRE;*STB;*TRG;*TST;*WAI;:CLRO;:CLRT;
:DATA1;:DATA2;:DATAA;:DATAF;:DATE;:DBRZ;:DCAL;
:DEL;:DELE;:DGAM;:DGFR;:DGR;:DGSQ;:DHOL;:DIMH;
:DIML;:DINP;:DISP;:DITH;:DOAM;:DOR;:DOUT;:DREF;
:DRGA;:DRGB;:DSR;:DSYN;:DTIM;:DTRG;:DWAV;:DZIN;
:ERRM;:FORM;:FUNC;:GAMP;:GEN;:GFRE;:GZ;:HEAD;
:HELP;:HOLD;:IMDH;:IMDL;:INP;:JAMP;:JFR;:JWAV;
:LIGH;:M1;:M2;:M3;:MF;:MP;:NAME;:OUTP;:PRIN;:PRN;
:PROT;:REFDBM;:REFDBR;:REFW;:REP;:RNGA;:RNGB;
:RNGM;:SDEL;:SETT;:SPO;:SRES;:STIM;:STOL;:SWE;
:TEST;:TIME;:TRIG;:VERB;:WAV;:ZINA;:ZINB;
:ACM:LUN;MMAX;MMIN;SET;UNIT;
:AMPL:AMAX;AMIN;BPFR;EXT;FILT;FMAX;FMIN;HPAS;LPAS;
MMAX;MMIN;SET;SPE;STEP;SWPT;UNIT;WTD;
:GENL:FMAX;FMIN;MMAX;MMIN;SET;SPE;STEP;UNIT;
:IMD:AMAX;AMIN;LUN;MMAX;MMIN;SET;SPE;STEP;UNIT;
:LEV:AMAX;AMIN;EXT;FMAX;FMIN;LUN;MMAX;MMIN;SET;
SPE;STEP;SWPT;UNIT;
:NOIS:AMAX;AMIN;BPFR;EXT;FILT;FMAX;FMIN;HPAS;LPAS;
MMAX;MMIN;SET;SPE;STEP;SWPT;UNIT;WTD;
:PHAS:AMAX;AMIN;AVER;EXT;FMAX;FMIN;LUN;MMAX;MMIN;
RANG;SET;SPE;STEP;SWPT;UNIT;
:RAT:AMAX;AMIN;EXT;FMAX;FMIN;LUN;MMAX;MMIN;MODE;
SET;SPE;STEP;SWPT;UNIT;
:SIN:HPAS;LPAS;LUN;MMAX;MMIN;NOTC;PRES;SET;TUN;
UNIT;
:THD:AMAX;AMIN;EXT;FILT;FMAX;FMIN;HPAS;LPAS;LUN;
MMAX;MMIN;NOTC;SET;SPE;STEP;SWPT;TUN;UNIT;WTD;
:WF:DET;FILT;LUN;MMAX;MMIN;RESP;SET;UNIT;WFUN;
:XTAL:AMAX;AMIN;EXT;FMAX;FMIN;LUN;MMAX;MMIN;SET;
SPE;STEP;SWPT;UNIT;
:DAMP:AMAX;AMIN;BPFR;EXT;FILT;FMAX;FMIN;HPAS;LPAS;
MMAX;MMIN;SET;SPE;STEP;SWPT;UNIT;WTD;
:DCHK:BITS;DBIT;DUN;MMAX;MMIN;SET;UNIT;
:DIMD:AMAX;AMIN;LUN;MMAX;MMIN;SET;SPE;STEP;UNIT;
:DIO:DDREF;DIR;DUN;FRQR;MMAX;MMIN;SET;UNIT;
:DIST:COD;CONF;DIST;ERROR;INV;LOCK;PAR;STAT;STDI;
:DJIT:AMAX;AMIN;BPFR;EXT;FILT;FMAX;FMIN;HPAS;JDET;
LUN;MMAX;MMIN;SET;SPE;STEP;SWPT;UNIT;
:DLEV:AMAX;AMIN;EXT;FMAX;FMIN;LUN;MMAX;MMIN;SET;
SPE;STEP;SWPT;UNIT;
:DNOIS:AMAX;AMIN;BPFR;EXT;FILT;FMAX;FMIN;HPAS;
LPAS;MMAX;MMIN;SET;SPE;STEP;SWPT;UNIT;WTD;
:DOST:CONS;DOST;PROF;STDO;VAL;
:DPHA:AMAX;AMIN;EXT;FMAX;FMIN;LUN;MMAX;MMIN;RANG;
SET;SPE;STEP;SWPT;UNIT;
:DRAT:AMAX;AMIN;EXT;FMAX;FMIN;LUN;MMAX;MMIN;SET;
SPE;STEP;SWPT;UNIT;
:DTHD:AMAX;AMIN;EXT;FILT;FMAX;FMIN;HPAS;LPAS;LUN;
MMAX;MMIN;NOTC;SET;SPE;STEP;SWPT;TUN;UNIT;WTD;
:DXTAL:AMAX;AMIN;EXT;FMAX;FMIN;LUN;MMAX;MMIN;SET;
SPE;STEP;SWPT;UNIT;

```

---

## LIGHT

Turns the display backlight on or off. The backlight automatically turns off after 2 hours of on time to increase the lifetime of the fluorescent backlight tube. The LIGHT ON command will turn on the backlight and restart the 2-hour timer.

**Related Commands:** None  
**Syntax:** LIGHT { ON | OFF }  
**Factory Default:** ON  
**Example:** LIGHT OFF

---

## LIGHT?

Returns the current state of the display backlight, either on or off.

**Related Commands:** None  
**Syntax:** LIGHT?  
**Example:** LIGHT?  
**Response:** :LIGHT OFF;

---

## NAME

Specifies the name of a numbered saved setting register which has been saved with the \*SAV command. The name will be displayed on the front panel when the STORE/RECALL panel is displayed. Any previous name will be replaced. An execution error will be generated if an attempt is made to specify a name for a numbered setting which is empty ( has no stored setting and indicates EMPTY on the STORE/RECALL panel). The numeric argument must be in the range of 0 to 29.

The name string may be up to fourteen characters in length and may be a NULL string (e.g., ""). A command error will be reported and the string will be discarded if it is over fourteen characters in length. Valid characters must be ASCII characters in the range of Hex 20 (dec 32) to Hex 7E (dec 126) character. See the ASCII Code Chart in Appendix A for more information. The following characters are interpreted as special characters in the display of the instrument:

\$ (dec 36) = D:  
 @ (dec 64) = A:  
 ^ (dec 94) = F<sub>5</sub>

Either single quotes (ASCII character 27 hex or 39 decimal) or double quotes (ASCII character 22 hex or 34 decimal) may be used to delimit the name string. Double quotes may be used within a string delimited by single quotes, and vice versa. However, if double quotes are used to delimit the string, then double quotes may not be used within the string. If single quotes are used to delimit the string, then single quotes may not be used within the string.

**Related Commands:** NAME?, \*RCL, \*SAV  
**Syntax:** NAME <nr1>, "namestring"  
**Example:** NAME 1, "TEST 1 - DISTORTION"

---

## NAME?

Returns the name of a numbered saved setting register that has been saved with the \*SAV command. The name is that which is displayed on the front panel when the STORE/RECALL panel is displayed. The name string "EMPTY" will be returned when an attempt is made to query a name for a numbered setting that is empty (has no stored setting).

The response name string will be delimited in double quotes.

**NOTE:** Names entered from the front panel Recall/Save menu may contain double quotes. If a Name? response contains double quotes, then this response cannot be used as a command. In order to preserve the name as a command, we recommend that you convert double quote characters to single quotes within the name string.

**Related Commands:** NAME, \*RCL, \*SAV

**Syntax:** NAME? <nr1>

**Example:** NAME? 1

**Response:** NAME 1, "EMPTY" ;

---

## PRINT

Initiates a printout of the selected item to the printer connected to the parallel port. Does not hang if no printer is connected. Refer to the users manual for the description of these printouts.

**Related Commands:** None

**Syntax:** PRINT { SCReen | TABLE | GRAPh | LINefeed | FORMfeed | READing | HEADer }

**Example:** PRINT GRAPH

---

## PRN

Selects the printer format to be used when a PRINT command is received to initiate a print to the printer on the parallel port. The possible printer formats are IBM for IBM compatible (Epson format), or PCL for HP Laserjet PCL4 format.

**Related Commands:** PRN?, PRINT

**Syntax:** PRN { IBM | PCL }

**Example:** PRN PCL

---

## PRN?

Returns the currently selected printer format for a print to the the parallel port, either IBM for IBM compatible (Epson format), or PCL for HP Laserjet PCL4 format.

**Related Commands:** PRN, PRINT

**Syntax:** PRN?

**Example:** PRN?

**Response:** :PRN IBM;

---

## PROTECT

Enables or disables protect mode for a saved instrument settings register. The argument specifies the saved settings register and its protect mode. A protect mode of ON means that the register contents (instrument settings and sweep data) may not be changed by the \*SAV command. A protect mode of OFF will allow a new instrument setting and data to be saved in that register with the \*SAV command. PROTECT ON does not prevent a settings register from being deleted by the DELETE command.

The range of register values is 0 to 29. An execution error will be reported if an empty register is specified.

**Related Commands:** PROTECT?, \*SAV

**Syntax:** PROTECT <nr1>, { OFF | ON }

**Example:** PROTECT 1, ON

---

## PROTECT?

Returns the protect mode for a saved instrument settings register. The argument specifies the saved settings register to be queried. The response indicates the saved settings register and its protect mode, either ON or OFF.

A protect mode of ON means that the register contents (instrument settings and sweep data) may not be changed by the \*SAV command. A protect mode of OFF will allow a new instrument setting and data to be saved in that register with the \*SAV command.

The range of register values is 0 to 29. An execution error will be reported if an empty register is specified.

**Related Commands:** PROTECT

**Syntax:** PROTECT? <nr1>

**Example:** PROTECT? 1

**Response:** :PROTECT 1, ON;

---

## SET?

This command returns settings for all commands with headers (i.e. implicit HEADER ON). The response will include settings for the currently selected measurement function. The response will always include the DISP GPIB command as the first message unit.

For the Portable One Plus Access (P1PA) this command is equivalent to sending the following query string followed by the SET? command for the measurement function presently displayed, followed by the DISPLAY? command. For example, if the LEVEL function is displayed, then the response to a :LEVEL:SET? command will be returned with the other query responses.

```
:FORMAT?; :FUNCTION?; :GAMPLITUDE?; :GFREQUENCY?;
:GZ?; :HEADER?; :IMDHF?; :IMDLF?; :INPUT?; :LIGHT?;
:OUTPUT?; :PRN?; :REFDBM?; :REFDBR?; :REFWATT?;
:RNGA?; :RNGB?; :RNGM?; :SDELAY?; :SETTLE?;
:SPOINTS?; :SRESOLUTION?; :STIMEOUT?;
:STOLERANCE?; :TRIGGER?; :VERBOSE?; :WAVEFORM?;
:ZINA?; :ZINB?; :LEVEL:SET?; :DISPLAY?
```

For the Portable One Dual Domain (P1DD) this command is

equivalent to sending the following query string followed by the SET? command for the measurement function presently displayed, followed by the DISPLAY? command. For example, if the LEVEL function is displayed, then the response to a :LEVEL:SET? command will be returned with the other query responses.

```
:DCAL?;:DGAMPLITUDE?;:DGFREQUENCY?;:DGRATE?;
:DGSQRFREQ?;:DHOLD?;:DIMHF?;:DIMLF?;:DINPUT?;
:DITHER?;:DOAMPLITUDE?;:DORESOLUTION?;:DOUTPUT?;
:DREFDBR?;:DRGA?;:DRGB?;:DSREF?;:DSYNCH?;
:DTRGOUT?;:DWAVEFORM?;:DZIN?;:FORMAT?;:FUNCTION?;
:GAMPLITUDE?;:GENERATOR?;:GFREQUENCY?;:GZ?;
:HEADER?;:IMDHF?;:IMDLF?;:INPUT?;:JAMPL?;:JFREQ?;
:JWAVE?;:LIGHT?;:OUTPUT?;:PRN?;:REFDBM?;:REFDBR?;
:REFWATT?;:RNGA?;:RNGB?;:RNGM?;:SDELAY?;:SETTLE?;
:SPOINTS?;:SRESOLUTION?;:STIMEOUT?;:STOLERANCE?;
:TRIGGER?;:VERBOSE?;:WAVEFORM?;:ZINA?;:ZINB?;
:LEVEL:SET?;:DISPLAY?;
```

**Group:** System

**Related Commands:** \*LRN?

**Syntax:** SET?

**Example:** SET?

**Access Response:**

```
DISP GPIB;:FORMAT ASCII;:FUNCTION LEVEL;
:GAMPLITUDE 1. V;:GFREQUENCY 1.E+3 HZ;:GZ B40;
:HEADER ON;:IMDHF 7000.;:IMDLF 60.;:INPUT A;
:LIGHT ON;:OUTPUT OFF;:PRN IBM;:REFDBM 600. OHM;
:REFDBR 1. V;:REFWATT 8. OHM;:RNGA -0.1;
:RNGB -0.1;:RNGM 1.;:SDELAY 7.5E-2;:SETTLE OFF;
:SPOINTS 3;:SRESOLUTION 1.E-7;:STIMEOUT 5.;
:STOLERANCE 1.;:TRIGGER OFF;:VERBOSE ON;
:WAVEFORM SINE;:ZINA HIGH;:ZINB HIGH;
:LEVEL:AMAX 1. V;AMIN 0. V;EXTERNAL GLIDE;
FMAX 20.E+3 HZ;FMIN 20. HZ;LUNIT V;MMAX 10. V;
MMIN 1.E-6 V;SPEED FAST;STEPS 0;SWPTYPE FREQ;
UNIT V;:DISPLAY GPIB;
```

**Dual Domain Response:**

```
DISP GPIB;:DCAL BAL;:DGAMPLITUDE 0. DBFS;
:DGFREQUENCY 997. HZ;:DGRATE 48000. HZ;
:DGSQRFREQ 1000. HZ;:DHOLD OFF;:DIMHF 7000.;
:DIMLF 60.;:DINPUT A;:DITHER TRI;
:DOAMPLITUDE 5. VPP;:DORESOLUTION 24;
:DOUTPUT OFF;:DREFDBR 1. FFS;:DRGA 0.;:DRGB 0.;
:DSREF OFF;:DSYNCH 0.;:DTRGOUT XMTFRAME;
:DWAVEFORM SINE;:DZIN HIGH;:FORMAT ASCII;
:FUNCTION LEVEL;:GAMPLITUDE 1. V;
:GENERATOR ANLG;:GFREQUENCY 1.E+3 HZ;:GZ B40;
:HEADER ON;:IMDHF 7000.;:IMDLF 60.;:INPUT A;
:JAMPL 0. UI;:JFREQ 1.002E+3 HZ;:JWAVE OFF;
:LIGHT ON;:OUTPUT OFF;:PRN IBM;:REFDBM 600. OHM;
:REFDBR 1. V;:REFWATT 8. OHM;:RNGA -0.1;
:RNGB -0.1;:RNGM 1.;:SDELAY 7.5E-2;:SETTLE OFF;
:SPOINTS 3;:SRESOLUTION 1.E-7;:STIMEOUT 5.;
:STOLERANCE 1.;:TRIGGER OFF;:VERBOSE ON;
:WAVEFORM SINE;:ZINA HIGH;:ZINB HIGH;
:LEVEL:AMAX 1. V;AMIN 0. V;EXTERNAL GLIDE;
FMAX 20.E+3 HZ;FMIN 20. HZ;LUNIT V;MMAX 10. V;
MMIN 1.E-6 V;SPEED FAST;STEPS 0;SWPTYPE FREQ;
UNIT V;:DISPLAY GPIB;
```

---

**TEST**

Executes the self test function in the AC Mains display menu and prints a table of the self test results on the printer connected to the parallel port. A self-test may be aborted with the SDC or DCL GPIB bus commands. The data will be tabular and consist of test number, test name, test value, applicable test limits (upper and lower), and PASS or FAIL for each test.

**Related Commands:** \*TST?

**Syntax:** TEST

**Example:** TEST

***CAUTION: The analog and digital outputs must be disconnected from any load before issuing the TEST command, otherwise the test may fail or damaging voltages may be applied to the device-under-test. To avoid this problem, use \*WAI as the first command after \*TST? to force the test to complete before subsequent commands are processed.***

---

**TIME?**

Returns the time in seconds since instrument power-on or the last CLRTime command. The TIME? query can be used to generate time stamps to determine approximate elapsed time between system events.

**Related Commands:** CLRTime; DTIME

**Syntax:** TIME?

**Example:** TIME?

**Response:** 2401.18;

---

## VERBose

Enables or disables verbose query responses. ON causes the full verbose forms of command headers and arguments to be returned in query responses and causes SET? and \*LRN? settings queries and the HELP? query to imbed carriage return/linefeed characters after each group of function settings for enhanced readability. OFF causes terse forms of command headers and arguments to be returned in query responses and no imbedded carriage return/linefeed characters after each group of function settings. Defaults to ON. OFF is recommended when the GPIB terminator is set to CRLF/EOI so that the entire query response can be read with only one linefeed delimiter.

**Related Commands:** All settings queries.

**Syntax:** VERBose { ON | OFF }

**Factory Default:** ON

**Example:** VERBOSE OFF

---

## VERBose?

Returns the current setting of the verbose command, ON or OFF.

**Related Commands:** None

**Syntax:** VERBose?

**Example:** VERBOSE?

**Response:** :VERB OFF;



# 3. Measurement Command Descriptions

This section describes alphabetically the Measurement commands, as listed in Section 1. Refer to Section 1 for a list of all commands by command groups, and for command notation and syntax.

---

## DATA1?

Returns sweep measurement data for the primary measurement meter, formatted according to the format specified by the current setting of the FORMAT command.

**Related Commands:** FORMat, DATA2?, DATAA?, DATAF?, SWEep

**Syntax:** DATA1?

**Example:** Send: FORMAT ASCII;DATA1?

Response: :DATA1 ASCII,V,4,5.996,5.997,5.998,5.987;

If the format is ASCII, the response consists of the DATA1 header, space delimited, followed by three argument fields and multiple data fields. Argument fields and data fields are all comma delimited. The last data field is semicolon delimited.

Field 1 the string ASCII,

Field 2 units for the selected function,

Field 3 the number of DATA POINTS to follow,

Field 4 the ASCII formatted IEEE numbers delimited with commas.

Send: FORMAT BINARY;DATA1?

Response: :DATA1

BINARY,V,4,#216<DAB><DAB><DAB><DAB><DAB><DAB>  
<DAB><DAB><DAB><DAB><DAB><DAB><DAB><DAB><DAB><DAB>;

If the format is either BINARY or LOWBINARY, the response consists of the header and seven fields. The entire response is delimited with a semicolon. Units will be dependent upon the function selected, usually V or FFS for amplitude functions, PCT for distortion, DEG for PHASE, and HZ for frequency.

Field 1 either the string BINARY or LOWBINARY to indicate the format of the binary data to follow,

Field 2 units for the selected function,

Field 3 the number of DATA POINTS to follow (each data point is a 4-byte binary word),

Field 4 the # character,

Field 5 a single digit indicating the number of bytes in field 6,

Field 6 the number of binary 8 bit data bytes to follow in field 7,

Field 7 the binary formatted data bytes.

The binary data bytes are encoded in one of two binary formats consisting of 4 byte fields of binary floating point coded values. The FORMAT BINARY command causes the instrument to format

response data as 32 bit four byte IEEE formatted numbers with the exponent sent as the first byte of the four byte word. The FORMAT LOWBINARY command causes the instrument to format response data as 32 bit four-byte IEEE-formatted numbers with the least significant byte of the mantissa sent first. The LOWBINARY format is the same format used by Intel processors and Microsoft compilers.

---

## DATA2?

Returns sweep measurement data for the secondary measurement meter when the LEVEL or DLEVEL function is selected. The response format is the same as that of the DATA1? command except that the header is DATA2.

**Related Commands:** FORMat, DATA1?, DATAA?, DATAF?, SWEep

**Syntax:** DATA2?

**Example:** DATA2?

**Response:** :DATA2 ASCII,V,4,6.001,5.998,5.998,5.986;

---

## DATAA?

Returns amplitude sweep data for the independent data axis, the X axis containing the swept values. The order of the data is the same sequence as measurement data returned with the DATA1? and DATA2? commands. This permits the measurement data and stimulus amplitude data to be correlated. The response format is the same as that of the DATA1? command except that the header is DATAA. Units are those currently specified for the generator currently selected for the amplitude sweep, specified by the last AMIN or AMAX command.

**Related Commands:** FORMat, DATA1?, DATA2?, DATAF?, SWEep

**Syntax:** DATAA?

**Example:** DATAA?

**Response:** :DATAA ASCII,DBFS,4,-60.0,-40.0,-20.0,-10.0;

---

## DATAF?

Returns frequency sweep data for the independent axis, the X-axis containing the swept values. The order of the data is the same sequence as measurement data returned with the DATA1? and DATA2? commands. This permits the measurement data and stimulus frequency data to be correlated. The response format is the same as that of the DATA1? command except that the header is DATAF. Units are always HZ.

**Related Commands:** FORMat, DATA1?, DATA2?, DATAA?, SWEep

**Syntax:** DATAF?

**Example:** DATAF?

**Response:** :DATAF ASCII,HZ,4,20.,200.,2.E+3,20.E+3;

---

## DBRZero

Sets the dBr reference value to the measured input level on the currently selected input channel when the measurement units are set to DBR. This changes the dBr reference value set by the REFDBR and DREFDBR commands.

For the Portable One Dual Domain this command sets the analog dBr reference if an analog measurement function is in use and sets the digital dBr reference if a digital measurement function is in use.

**Related Commands:** FUNCTION, REFDBR, DREFDBR

**Syntax:** DBRZero

**Example:** Select amplitude function, set amplitude units to dBr, set dbrzero to the current measurement.

```
FUNCTION AMPLITUDE; :AMPLITUDE:UNIT DBR; :DBRZERO
```

---

## FORMat

Specifies the format of data returned with the DATA1?, DATA2?, DATAA?, and DATAF? sweep data queries. The format of the measurement data is either ASCII <NR3 NUMERIC RESPONSE DATA> values or one of two binary formats which are <DEFINITE LENGTH ARBITRARY BLOCK RESPONSE DATA> consisting of 4 byte fields of binary floating point coded values. The FORMAT BINary command causes the instrument to format response data as 32 bit four byte IEEE formatted numbers with the exponent sent as the first byte of the four byte word. The FORMAT LOWBinary command causes the instrument to format response data as 32 bit four byte IEEE formatted numbers with the least significant byte of the mantissa sent first. See the DATA1? command for details of the response syntax for these formats.

**Related Commands:** DATA1?, DATA2?, DATAF?

**Syntax:** FORMat { ASCii | BINary | LOWBinary }

**Factory Default:** ASCII;

**Example:** FORMAT ASCII

---

## FORMat?

Returns either ASCII ,BINARY, or LOWBINARY as the current setting of the FORMAT command for sweep data formats.

**Related Commands:** DATA1?, DATA2?, DATAF?

**Syntax:** FORMat?

**Example:** FORMAT?

**Response:** :FORMAT ASCII;

---

## FUNCTION

Turns on the specified audio analyzer measurement function for the analog analyzer or the digital analyzer. The function is enabled with all parameters previously specified.

This command has additional arguments for the digital domain measurement functions for the Portable One Dual Domain. Some functions change the generator waveform. See the section starting on page 1-21 for information about how this command causes changes to the analog and digital generators.

**Related Commands:** FUNCTION?, GAMPLitude, GFRequency, OUTput, WAVeform, DGAMplitude, DGFRequency, DOUTput, DWAVeform

**Access Syntax:** FUNCTION { AMPLitude | NOISe | THD | SINad | IMD | WF | ACMains | LEVel | PHASe | RATio | XTALK | GENLoad }

**Dual Domain Syntax:** FUNCTION { AMPLitude | NOISe | THD | SINad | IMD | WF | ACMains | LEVel | PHASe | RATio | XTALK | GENLoad | DAMPLitude | DNOise | DTHD | DIMD | DLEVel | DPHase | DRATio | DXTalk | DJITter | DCHK | DIO }

**Factory Default:** LEVEL

**Example:** FUNCTION AMPLITUDE

---

## FUNCTION?

Returns the currently active audio analyzer measurement function for the analog analyzer or the digital analyzer.

**Related Commands:** FUNCTION, GAMPLitude, GFRequency, OUTput, WAVeform, DGAMplitude, DGFRequency, DOUTput, DWAVeform

**Syntax:** FUNCTION?

**Example:** FUNCTION?

**Response:** :FUNCTION AMPLITUDE;

---

## M1?

Returns the next available measurement from the main measurement meter (left displayed measurement on the front panel). This meter is dependent on the currently selected analog or digital measurement function. Resolution is the same as displayed on the front panel.

The format of the response is in the form :M1X <nrf> UNIT, where X represents the settled state of the measurement. X may be S, U, or N, as follows:

- :M1S <nrf> UNIT; for settled measurements when settling is enabled,
- :M1U <nrf> UNIT; for unsettled measurements when settling is enabled,
- :M1N <nrf> UNIT; for non-settled measurements when settling is disabled.

UNIT is the units of the measurement. For the Portable One Plus Access the units may be V, DB, DBM, DBV, DBU, DBR, DBG, WATT, DEG, PCT, ERR, OHM, HZ, or X/Y. For the Portable One Dual Domain the units may be V, DB, DBM, DBV, DBU, DBR,

DBG, WATT, DEG, PCT, ERR, OHM, FFS, DBFS, HZ, PPM, NORM, TOTAL, X/Y, UI, or SEC.

**Related Commands:** M2?, MF?, MP?  
**Syntax:** M1?  
**Example:** M1?  
**Response:** :M1N 12.39E-6V;

---

## M2?

Returns the next available measurement from the secondary meter (center displayed measurement on front panel). This meter is dependent on the currently selected analog or digital measurement function. Resolution is the same as displayed on the front panel. Overrange measurements respond with the  $-1E+30$  number with the ERR unit.

The measurement may be a settled measurement if the LEVEL function is selected, with the same settling information in the header as the :M1? response. The measurement response will have the format :M2N <nrf> units; for all functions except LEVEL. The response format may be either :M2S <nrf> units; or :M2U <nrf> units; if the LEVEL function is selected.

For the Portable One Plus Access, the unit may be V, DBM, DBV, DBU, DBR, DBG, WATT, ERR, OFF, or PCT, depending upon the currently selected measurement function or overrange condition.

For the Portable One Dual Domain the unit may be V, DBM, DBV, DBU, DBR, DBG, WATT, ERR, OFF, PCT, FFS, DBFS, VPP, NORM, or TOTAL, depending upon the currently selected measurement function or overrange condition.

**Related Commands:** M1?, MF?, MP?  
**Syntax:** M2?  
**Example:** M2?  
**Response:** :M2U 23.55E-6 V;  
 :M2N -1.E+30 ERR;

**M3?****Dual Domain only**

This query returns the next available measurement from the third meter (right displayed measurement on front panel). This meter is dependent on the currently selected analog or digital measurement function and may return measurements of the frequency meter (MF?), the phase meter (MP?), the digital delay meter for the DIO measurement function, or the digital audio data meter for the DataCheck measurement function. Resolution is the same as displayed on the front panel.

Two response formats are possible, depending on the measurement function that is currently selected when the M3? query is sent.

The format is in the form:

```
:M3N { <nrf> | <HEXADECIMAL NUMERIC RESPONSE DATA> } UNIT
```

The M3? Measurements are always non-settled. The 4th character of the header is always encoded N for a non-settled measurement.

The numeric response may be either a floating point number in decimal representation or a hexadecimal number. The hexadecimal number format will be returned only when the DataCheck measurement function is displayed and HEX units are selected for the DATA meter with the :DCHK:DUNIT HEX command.

UNIT may be HZ, DEG, DPCT3000, DPCT3150, SEC, SMP (samples), UI, DEC, HEX, or ERR.

Overrange measurements are indicated by the -1E+30 number with the ERR unit.

If the unit is HEX (hexadecimal), then the numeric response will be formatted as a hex number. The hex number is preceded with two characters, #H (ASCII character 35 followed by ASCII character 72) followed by 6 hex digits (0 - 9 and A - F, ASCII 48 - 57 and 65 - 72). For example, the response will be #H7FFFFFFC if data is +1.000 FFS and #H800000 if data is -1.000 FFS.

**Related Commands:** MP?, MF?

**Syntax:** M3?

**Example:** M3?

**Response:**

```
:M3N #H400000 HEX;
:M3N 998.84 HZ;
:M3S -0.2 DEG;
:M3N 4.5E+1 UI;
:M3N -1.E+30 ERR;
```

---

**MF?**

Returns the next available measurement from the analog (Access & Dual Domain) or digital (Dual Domain) frequency meter. Resolution is the same as displayed on the front panel. The measurement response has the format :MFN <nrf> HZ;

Units will be HZ except that in the case of Wow and Flutter measurements with % frequency, the units will be DPCT3000 or DPCT3150. In distortion modes, units will be AUTO, FIXTUNE, GENTRACK, OFF, or ERR, depending upon the notch filter tuning mode and display mode.

**Related Commands:** M1?, M2?, MP?

**Syntax:** MF?

**Example:** MF?

**Response:** :MFN 998.84 HZ;

---

**MP?**

Returns the next available measurement from the analog (Access & Dual Domain) or digital (Dual Domain) phase meter. Resolution is the same as displayed on the front panel. The phase meter will provide valid measurements for DLEVEL, DRATIO, DPHASE, LEVEL, RATIO, or PHASE functions only and will return the invalid reading number if any other functions are selected. If DPHASE or PHASE function is selected, the response is the same number returned by the M1? query.

The response header is :MP<x> where <x> is either N (non-settled), S (settled), or U (unsettled). S and U can only be returned if the PHASE function is selected and settling is enabled.

The units are always DEG (degrees) and are included for consistency with the other measurement queries.

**Related Commands:** M1?

**Syntax:** MP?

**Example:** MP?

**Response:** :MPN -0.2 DEG;

---

**REPeat**

Starts a sweep in a repeating mode. Data from a previous sweep is replaced as the new sweep progresses. A sweep may be stopped with the DCL (Device Clear) or SDC (Select Device Clear) interface commands or a return to local control (LOCS or LWLS) caused by a front-panel button press if the front panel is not locked out. Measurements acquired from the most recent sweep are available with the sweep data queries DATA1?, DATA2?, and DATAF?.

**Related Commands:** SWEEP

**Syntax:** REPeat

**Example:** REPeat

---

## SDElay

Sets the value of the settling delay parameter used for all measurement functions when settling is enabled (SETTle ON has been sent). Units are in seconds, range 0.03 to 10. Use longer values for low frequencies below 20 Hz for best settling results.

**Related Commands:** SETTle, SPOints, SRESolution, STIMEout, STOLerance

**Syntax:** SDElay <nrf>

**Factory Default:** .075

**Example:** SDELAY 0.1

---

## SDElay?

Returns the value of the settling delay parameter used for all measurement functions when settling is enabled.

**Related Commands:** SETTle, SPOints, SRESolution, STIMEout, STOLerance

**Syntax:** SDElay?

**Example:** SDELAY?

**Response:** :SDELAY 7.5E-2;

---

## SETTle

Enables or disables use of the settling algorithm for measurement acquisition. Only measurements returned with the :M1? command will be processed with the settling algorithm.

**OFF** makes measurements at the fastest rate with no settling.

**ON** makes measurements using the settling algorithm with the timeout, delay, tolerance, resolution, and points parameters. A measurement will be provided when settled or when the timeout has been exceeded.

**AUTO** makes settled measurements with the settling algorithm using function-specific settling parameters which are dependent upon the sweep settings for that function (FMAX, FMIN, SPEED, and STEPS). AUTO is recommended for most applications.

**Related Commands:** SPOints, SRESolution, STIMEout, STOLerance, SDElay, measurement function sweep parameters (STEPS, EXTERNAL, SWEep)

**Syntax:** SETTle { OFF | ON | AUTO }

**Factory Default:** OFF

**Example:** SETTLE ON

---

## SETTle?

Returns the state of the SETTLE command: OFF, ON, or AUTO.

**Related Commands:** SPOints, SRESolution, STIMEout, STOLerance, SDElay, measurement function sweep parameters (STEPS, EXTERNAL, SWEEP)

**Syntax:** SETTle?

**Example:** SETTLE?

**Response:** :SETTLE ON;

---

## SPOints

Sets the number of measurement points to use for the settling algorithm when SETTle ON is selected. Range may be 2 or 3. Any other value is rounded to the nearest of 2 or 3.

**Related Commands:** SDElay, SRESolution, STIMeout, STOLerance, SETTle

**Syntax:** SPOints { 2 | 3 }

**Factory Default:** 3

**Example:** SPOINTS 2

---

## SPOints?

Returns the number of measurement points to use for the settling algorithm when SETTle ON is selected. Response is 2 or 3.

**Related Commands:** SDElay, SRESolution, STIMeout, STOLerance, SETTle

**Syntax:** SPOints?

**Example:** SPOINTS?

**Response:** :SPOINTS 2;

---

## SRESolution

Sets the settling resolution value used for all measurement functions when SETTle ON is selected. Settling resolution sets a lower resolution bound, below which readings whose difference is less than this value will be considered settled.

**Related Commands:** SETTle, STOLerance, SDElay, STIMeout, SPOints

**Syntax:** SRESolution <nrf>

**Factory Default:** 1.0E-7

**Example:** SRESOLUTION 0.0001

---

## SRESolution?

Returns the settling resolution value in use when SETTle ON is selected.

**Related Commands:** SETTle, STOLerance, SDElay, STIMeout, SPOints

**Syntax:** SRESolution?

**Example:** SRESOLUTION?

**Response:** :SRESOLUTION 1.E-4;

---

## STIMeout

Specifies the time-out parameter for the measurement settling algorithm when SETTle ON is selected. If settling does not occur within the time-out interval, the average of the number of readings specified by SPOints in the settling buffer is output as the M1? measurement. Range is 0.2 to 60 seconds.

**Related Commands:** SETTle, STOLerance, SDElay, SPOints

**Syntax:** STIMeout <nrf>

**Factory Default:** 5

**Example:** STIMEOUT 2

---

## STIMEout?

Returns the settling time-out parameter used by the settling algorithm when SETTle ON is selected.

**Related Commands:** SETTle, STOLerance, SDELay, SPOints

**Syntax:** STIMEout:

**Example:** STIMEOUT?

**Response:** :STIMEOUT 2. ;

---

## STOLerance

Specifies the settling tolerance in percent units when SETTle ON is selected. Range is 0.0 to 100.0 percent.

**Related Commands:** SETTle, SPOints, SDELay, STIMEout, SRESolution

**Factory Default:** 1

**Syntax:** STOLerance <nrf>

**Example:** STOLERANCE 5

---

## STOLerance?

Returns the settling tolerance in percent units.

**Related Commands:** SETTle, SPOints, SDELay, STIMEout, SRESolution

**Syntax:** STOLerance?

**Example:** STOLERANCE?

**Response:** :STOLERANCE 5. ;

---

## SWEEp

SWEEP START initiates a measurement sweep with the currently selected function and associated sweep parameters. The sweep command is a sequential command. Special rules apply to the treatment of commands received after the SWEEP START command and before termination of the sweep process.

Query commands will be processed during the sweep (after a SWEEP START command) until a non-query command is received. This allows measurements to be acquired during the sweep and allows generator, analyzer, and function settings to be queried during the sweep. All subsequent non-query commands will be buffered but not executed during the sweep. However, the SWEEP STOP command will be executed and will stop the sweep in process if it is the first non-query command to be received after the SWEEP START command.

A sweep in progress can be stopped by pressing a front-panel button (if not in lockout state) or by sending the SWEEP STOP command (see special rules above), or DCL (Device Clear) or SDC (Select Device Clear) GPIB bus commands. All buffered sweep measurements acquired before the sweep is stopped are available with the data queries (DATA1?, DATA2?, DATAA?, DATAF?). All commands sent after the sweep has been started will be lost (input queue cleared) if the sweep is stopped by either the SDC or DCL interface commands.

**Related Commands:** DATA1?,DATA2?, DATAA?, DATAF?, and measurement function settings STEPs, AMAX, AMIN, FMAX, FMIN, and EXTERNAL

**Syntax:** SWEEp { START | STOP }

**Factory Default:** STOP

**Example:** SWEEP START

---

## SWEEp?

Returns the state of sweep execution, either START if running, or STOP if the sweep has terminated. START indicates a self test is running if DISPLAY is set to TEST.

**Related Commands:** DATA1?,DATA2?, DATAA?, DATAF?, and measurement function settings STEPs, FMAX, FMIN, and EXTERNAL

**Syntax:** SWEEp?

**Example:** SWEEP?

**Response:** :SWEEP START;

---

## TRIGger

Specifies whether measurements are free run or triggered. The ON argument specifies that a measurement will not be made until a trigger message is received with either the \*TRG command or a Group Execute Trigger (GET) GPIB bus message. If settling is enabled, the settling buffer is cleared when the trigger message is received and measurement acquisitions occur until settling is achieved or a settling time-out occurs. If settling is disabled, a single measurement acquisition is triggered. OFF disables the trigger function and causes measurements to be acquired in a free-run mode.

For a full explanation of triggered measurements, see page 1-21.

**Related Commands:** \*TRG

**Syntax:** TRIGger { ON | OFF }

**Factory Default:** OFF

**Example:** TRIGGER ON

---

## TRIGger?

Returns the setting of the TRIGger command, either ON or OFF.

**Related Commands:** \*TRG

**Syntax:** TRIGger?

**Example:** TRIGGER?

**Response:** :TRIGGER ON;



# 4. Analog Generator Command Descriptions

This section describes alphabetically the Analog Generator commands, as listed in Section 1. Refer to Section 1 for a list of all commands by command groups, and for command notation and syntax.

---

## GAMplitude

Sets the analog generator output amplitude in selected units. The default unit is volts.

**Related Commands:** FUNCtion, GFREquency, GZ

**Syntax:** GAMplitude <nrf> [ VPK | Vrms | DBV | DBU | DBM ]

**Factory Default:** 1 VRMS

**Example:** GAMPLITUDE 2 DBU

---

## GAMplitude?

Returns the current analog generator amplitude setting and units.

**Related Commands:** FUNCtion, GFREquency, GZ

**Syntax:** GAMplitude?

**Example:** GAMPLITUDE?

**Response:** :GAMPLITUDE 2 DBU;

---

## GFREquency

Sets the analog generator frequency to the specified value. Default units are Hz. Units are optional.

**Related Commands:** FUNCtion, GAMplitude, GZ

**Syntax:** GFREquency <nrf>

**Factory Default:** 1 KHZ

**Example:** GFREQUENCY 12345.6

---

## GFREquency?

Returns the current analog generator frequency value.

**Related Commands:** FUNCtion, GAMplitude, GZ

**Syntax:** GFREquency?

**Example:** GFREQUENCY?

**Response:** :GFREQUENCY 12.345E+3 HZ;

---

**GZ**

Selects the analog generator output impedance in ohms and configuration. U indicates unbalanced; B indicates balanced. Any of the 40 or 50 ohm settings can be used to select the 40 ohm output impedance for the Portable One Dual Domain, Portable One Plus Access, or 50 ohm output impedance for ATS-1 Dual Domain and ATS-1 Access. For example, sending `GZ U50;` to a Portable One will result in a U40 setting.

**Related Commands:** GZ?

**Syntax:** GZ { U40 | U50 | B40 | B50 | B150 | B600 }

**Factory Default:** B40

**Example:** GZ B600

---

**GZ?**

Returns the currently selected analog generator output impedance and configuration.

**Related Commands:** GZ

**Syntax:** GZ?

**Example:** GZ?

**Response:** :GZ B600;

---

**IMDHF**

Selects the analog generator IMD high frequency tone for the IMD waveform. The numeric argument will be interpreted to be the nearer of the two valid frequencies in Hz units and will not generate an error if not set to exactly 7000 or 8000.

**Related Commands:** IMDHF?, FUNCtion, WAVeform

**Syntax:** IMDHF { 7000 | 8000 }

**Factory Default:** 7000

**Example:** IMDHF 7000

---

**IMDHF?**

Returns the analog generator IMD high frequency tone for the IMD waveform.

**Related Commands:** IMDLF, FUNCtion, WAVeform

**Syntax:** IMDHF?

**Example:** IMDHF?

**Response:** :IMDHF 7000.;

---

**IMDLf**

Selects the analog generator IMD low frequency tone for the IMD waveform. The numeric argument will be interpreted to be the nearer of the two valid frequencies in Hz units and will not generate an error if not set exactly to one of the valid frequencies.

**Related Commands:** IMDLf?, FUNction, WAVeform

**Syntax:** IMDLf { 50 | 60 | 70 | 250 }

**Factory Default:** 60

**Example:** IMDLf 50

---

**IMDLf?**

Returns the analog generator IMD low frequency tone for the IMD waveform.

**Related Commands:** IMDLf, FUNction, WAVeform

**Syntax:** IMDLf?

**Example:** IMDLf?

**Response:** :IMDLf 50.;

---

**OUTPut**

Selects the analog generator output channel. Selecting channel A connects the generator to the channel A output and does not affect the status of the B output. Selecting OFF turns off both A and B outputs. Selecting ON turns on both outputs.

**Related Commands:** FUNction

**Syntax:** OUTPut { OFF | ON | A | B }

**Factory Default:** OFF

**Example:** OUTPut ON

---

**OUTPut?**

Returns the current state of the analog generator outputs: OFF, ON, A, or B.

**Related Commands:** FUNction

**Syntax:** OUTPut?

**Example:** OUTPut?

**Response:** :OUTPut ON;

## WAVeform

Selects the analog generator waveform for output. Overrides the generator settings resulting from selecting a measurement function. A measurement function enabled after this command may set the waveform differently.

**Related Commands:** FUNCtion, GFREquency, GAMplitude

**Syntax:** WAVeform { SINE | SQUARE | IMD }

**Factory Default:** SINE

**Example:** WAVEFORM SQUARE

---

## WAVeform?

Returns the current analog generator waveform setting resulting from the WAVeform command or a FUNCtion setting.

**Related Commands:** FUNCtion, GFREquency, GAMplitude

**Syntax:** WAVeform?

**Example:** WAVEFORM?

**Response:** :WAVEFORM SQUARE;

# 5. Analog Analyzer Command Descriptions

This section describes alphabetically the Analog Analyzer commands, as listed in Section 1. Refer to Section 1 for a list of all commands by command groups, and for command notation and syntax.

---

## HOLD

Holds the analog A and B input ranges and the analog measurement amplifier range at the present values and disables auto-ranging until the RNGA, RRGB, RNGM, or FUNCTION commands are sent.

An input overrange condition will cause an erroneous reading. An input overrange condition will occur if the input signal is greater than the fixed input range set by HOLD. To avoid this condition be sure the input signal has settled to a steady state level before sending the HOLD command.

**Related Commands:** RNGA, RRGB, RNGM, FUNCTION

**Syntax:** HOLD

**Example:** HOLD

---

## INPUt

Selects the Analog Analyzer input channel to be measured, depending on the measurement function currently selected. If an analog measurement function is selected, then this command selects the analog signal source to connect to the M1 and M2 meters. Stores the setting but does not execute it if a digital measurement function is currently selected. The analog input setting will be restored when an analog measurement function is selected.

GAGB and GBGA are valid only when LEVEL, PHASE, or RATIO functions are selected with the FUNCTION command. GAGB selects GENA for meter 1 and GENB for meter 2. GBGA selects GENB for meter 1 and GENA for meter 2. A selects A input, B selects B input. GENA selects generator A output, GENB selects generator B output.

**Related Commands:** FUNCTION

**Syntax:** INPUt { A | B | GENA | GENB | GAGB | GBGA }

**Factory Default:** A

**Example:** INPUT A

---

## INPUt?

Returns the current selected Analog Analyzer input channel.

**Related Commands:** FUNCTION

**Syntax:** INPUt?

**Example:** INPUT?

**Response** :INPUT A;

---

## REFDBM

Analog Analyzer dBm measurements are calculated from input voltage and an assumed load resistance. The REFDBM command sets the value of the assumed load resistance in ohms. The range is 1 to 900 with resolution of 1 ohm.

**Related Commands:** UNIT  
**Syntax:** REFDBM <nrf>  
**Factory Default:** 600  
**Example:** REFDBM 16

---

## REFDBM?

Returns the current value of load resistance in ohms used for Analog Analyzer dBm measurement calculations.

**Related Commands:** None  
**Syntax:** REFDBM?  
**Example:** REFDBM?  
**Response:** :REFDBM 16. OHM;

---

## REFDBR

Sets the Analog Analyzer dBr reference value in designated units. The default unit is V (volts) if no unit is specified. Optional units are V (rms volts), DBV, DBU, DBM, and W (watts). Range in volts is 1E-9 to 500.

**Related Commands:** DBRZERO, UNIT  
**Syntax:** REFDBR <nrf> [ V | DBV | DBU | DBM | W ]  
**Factory Default:** 1 V  
**Example:** REFDBR 1.5 V;

---

## REFDBR?

Returns the current analog analyzer dBr reference value in volts.

**Related Commands:** DBRZERO  
**Syntax:** REFDBR?  
**Example:** REFDBR?  
**Response:** :REFDBR 1.5 V;

---

## REFWatt

Sets the value of resistance in ohms for watts calculations when watts units are selected. The range is 1 to 900  $\Omega$ .

**Related Commands:** UNIT  
**Syntax:** REFWatt <nrf>  
**Factory Default:** 8  
**Example:** REFWATT 50

---

## REFWatt?

Returns the current value of impedance in ohms used for watts calculations.

**Related Commands:** None

**Syntax:** REFWatt?

**Example:** REFWATT?

**Response:** :REFWATT 50. OHM;

---

## RNGA

Sets Analog Analyzer input A preamplifier voltage range to a valid range equal to or greater than the numeric argument. A value of 0 enables auto-ranging. A negative value sets the specified range and then enables auto-ranging. Ranges are: 0.1, 0.25, 1.0, 2.5, 10, 25, 100, 250 V<sub>rms</sub>. Autoranging is re-enabled if a FUNCTION command is received or if the instrument returns to the LOCAL mode because a front panel button was pressed.

**Related Commands:** HOLD, FUNCtion

**Syntax:** RNGA <nrf>

**Factory Default:** 0

**Example:** RNGA 5.5

---

## RNGA?

Returns the current Analog Analyzer input A preamplifier range. A negative number indicates that autoranging is enabled.

**Related Commands:** HOLD, FUNCtion

**Syntax:** RNGA?

**Example:** RNGA?

**Response:** :RNGA 5.5;

---

## RNGB

Sets Analog Analyzer input B preamplifier range to a valid range equal to or greater than the numeric argument. A value of 0 enables auto-ranging. A negative value sets the specified range and then enables auto-ranging. Ranges are: 0.1, 0.25, 1.0, 2.5, 10, 25, 100, 250 V<sub>rms</sub>. Autoranging is re-enabled if a FUNCTION command is received or if the instrument returns to the LOCAL mode because a front panel button was pressed.

**Related Commands:** HOLD, FUNCtion

**Syntax:** RNGB <nrf>

**Factory Default:** 0

**Example:** RNGB 17.5

---

**RNGB?**

Returns the current Analog Analyzer input B preamplifier range. A negative number indicates that autoranging is enabled.

**Related Commands:** HOLD, FUNCtion

**Syntax:** RNGB?

**Example:** RNGB?

**Response:** :RNGB -0.1;

---

**RNGM**

Sets the Analog Analyzer measurement amplifier gain ratio to a valid range equal to or greater than the numeric argument. A value of 0 enables auto-ranging. A negative value sets the specified range and then enables auto-ranging. Ranges are: 0, 1, 10, 100, 1000.

Autoranging is re-enabled if a FUNCTION command is received or if the instrument returns to the LOCAL mode because a front panel button was pressed.

**Related Commands:** RNGM?

**Syntax:** RNGM <nrf>

**Factory Default:** 0

**Example:** RNGM 10

---

**RNGM?**

Returns the current Analog Analyzer measurement amplifier range. A negative number indicates that autoranging is enabled.

**Related Commands:** RNGM

**Syntax:** RNGM?

**Example:** RNGM?

**Response:** :RNGM -1000.;

---

**ZINA**

Sets the channel A analog input impedance to 100 K ohm if the argument is HIGH, or to 600 ohm if the argument is LOW ohm. An excessively high input level with the impedance set to 600 ohms will cause the input protection circuit to trip, setting the input impedance to 100 K ohm.

**Group:** System

**Related Commands:** None

**Syntax:** ZINA { HIGH | LOW }

**Example:** ZINA LOW

---

**ZINA?**

Returns the current setting of the channel A analog input impedance setting. The response will be HIGH if the input impedance is 100 K ohm, or LOW if the input impedance is 600 ohm.

**Group:** System

**Related Commands:** None

**Syntax:** ZINA?

**Example:** ZINA?

**Response:** :ZINA HIGH;

---

**ZINB**

Sets the channel B analog input impedance to 100 K ohm if the argument is HIGH, or to 600 ohm if the argument is LOW ohm. An excessively high input level with the impedance set to 600 ohms will cause the input protection circuit to trip, setting the input impedance to 100 K ohm.

**Group:** System

**Related Commands:** None

**Syntax:** ZINB { HIGH | LOW }

**Example:** ZINB LOW

---

**ZINB?**

Returns the current setting of the channel B analog input impedance setting. The response will be HIGH if the input impedance is 100 K ohm, or LOW if the input impedance is 600 ohm.

**Group:** System

**Related Commands:** None

**Syntax:** ZINB?

**Example:** ZINB?

**Response:** :ZINB HIgh;

---

## ACMains:

Compound command header for the AC Mains measurement parameters.

---

### ACMains:LUNit

Selects the THD+N display units for the ACMAINS measurement function.

PCT selects percent units. OFF turns the THD+N display off.

**Related Commands:** ACMains:LUNit?

**Syntax:** ACMains:LUNit { PCT | OFF }

**Factory Default:** PCT

**Example:** ACMains:LUNit PCT

---

### ACMains:LUNit?

Returns the THD+N display units for the ACMAINS measurement function.

**Related Commands:** ACMains:LUNit

**Syntax:** ACMains:LUNit?

**Example:** ACMains:LUNit?

**Response:** LUNIT PCT;

---

### ACMains:MMAx

Selects the upper magnitude display range for the bargraph display in volts.

**Related Commands:** ACMains:MMIN, ACMains:MMAx?

**Syntax:** ACMains:MMAx <nrf>

**Factory Default:** 300

**Example:** ACMAINS:MMAx 130

---

### ACMains:MMAx?

Returns the current upper magnitude range setting for the bargraph display in volts.

**Related Commands:** ACMains:MMAx

**Syntax:** ACMains:MMAx?

**Example:** ACMAINS:MMAx?

**Response:** MMAx 130. V;

---

### ACMains:MMIN

Selects the lower magnitude display range for the bargraph display in volts.

**Related Commands:** ACMains:MMAx, ACMains:MMIN?

**Syntax:** ACMains:MMIN <nrf>

**Factory Default:** 0

**Example:** ACMAINS:MMIN 100

---

**ACMains:MMIN?**

Returns the current lower magnitude range setting for the bargraph display in volts.

**Related Commands:** ACMains:MMIN

**Example:** ACMAINS:MMIN?

**Response:** MMIN 100. V;

---

**ACMains:SET?**

Returns the query responses for all the queries under the :ACMAINS: compound command header. The response is preceded by :DISP GPIB and followed by :DISPLAY *current\_display\_panel*.

Equivalent to sending the following query string:

```
ACMAINS:LUNIT?;MMAX?;MMIN?;UNIT?;
```

**Related Commands:** All ACMains: queries

**Syntax:** ACMains:SET?

**Example:** ACMAINS:SET?

**Response:** :DISP GPIB;:ACMAINS:LUNIT PCT;MMAX 300. V;MMIN 0. V;UNIT V;:DISPLAY PANEL;

---

**ACMains:UNIT**

Selects the default volts measurement units for the ACMAINS function. This command is included only for the sake of consistency and is not needed to specify volts units.

**Related Commands:** ACMains:UNIT?

**Syntax:** ACMains:UNIT V

**Factory Default:** V

**Example:** ACMAINS:UNIT V;

---

**ACMains:UNIT?**

Returns the V units setting for the ACMAINS function.

**Related Commands:** ACMains:UNIT

**Syntax:** ACMains:UNIT?

**Example:** ACMAINS:UNIT?

**Response:** UNIT V;

---

## AMPLitude:

Compound command header for the Amplitude measurement function.

---

### AMPLitude:AMAX

For the Access instrument, this command sets the maximum amplitude level for an amplitude sweep of the analog generator when the SWPType command is set to AMPL. For the Dual Domain instrument this command sets the maximum amplitude level for an amplitude sweep of the analog generator, the digital generator, or the jitter generator when the SWPType command is set to AMPL.

The numeric argument and its unit should be within the valid amplitude range of the generator and its waveform type. Thus for the Access instrument, the maximum level for an amplitude sweep will be the argument value and units for the analog generator. For the Dual Domain instrument, the maximum level for an amplitude sweep will be the argument value and units for the generator last selected with the GENERator command or selected by the user with the front panel OUTPUT button.

If the AMAX argument value is less than the current setting of the AMIN command but within the range of the generator, then the AMIN command setting will be coerced to a lower value and no error will be generated.

Error 4 “CONFLICT WITH MAXIMUM AMPLITUDE” will be generated if the argument is outside of the range of the generator.

For the Dual Domain instrument, set the generator type and unit before sending the AMAX command. Subsequent changes to the generator type may cause the AMAX setting to be changed.

See Section 1 General Information – Sweeps for more information about interactions between amplitude sweep parameters and changes of the currently selected generator.

**Related Commands:** AMPLitude:AMIN, AMPLitude:AMAX?, SWPType

**Syntax:** AMPLitude:AMAX <nrf> unit

**Factory Default:** 1.0 V

**Example:** AMPLITUDE:AMAX 1. V

---

### AMPLitude:AMAX?

Returns the maximum amplitude level set by the AMAX command.

**Related Commands:** AMPLitude:AMAX

**Syntax:** AMPLitude:AMAX?

**Example:** AMPLITUDE:AMAX?

**Response:** AMAX 1. V;

---

### AMPLitude:AMIN

For the Access instrument, this command sets the minimum amplitude level for an amplitude sweep of the analog generator when the SWPType command is set to AMPL. For the Dual Domain instrument this command sets the minimum amplitude level for an amplitude sweep of the analog generator, the digital generator, or the

jitter generator when the SWPType command is set to AMPL.

The numeric argument and its unit should be within the valid amplitude range of the generator and its waveform type. Thus for the Access instrument, the minimum level for an amplitude sweep will be the argument value and units for the analog generator. For the Dual Domain instrument, the minimum level for an amplitude sweep will be the argument value and units for the generator last selected with the GENerator command or selected by the user with the front panel OUTPUT button.

If the AMIN argument value is greater than the current setting of the AMAX command but within the range of the generator, then the AMAX command setting will be coerced to a higher value and no error will be generated.

Error 5 “CONFLICT WITH MINIMUM AMPLITUDE” will be generated if the argument is outside of the range of the generator.

For the Dual Domain instrument, set the generator type and unit before sending the AMIN command with compatible units. Subsequent changes to the generator may cause the AMIN setting to be changed.

See Section 1 General Information – Sweeps for more information about interactions between amplitude sweep parameters and changes of the currently selected generator.

**Related Commands:** AMPLitude:AMIN?, AMPLitude:AMAX, SWPType

**Syntax:** AMPLitude:AMIN <nrf> unit

**Factory Default:** 1.0E-3

**Example:** AMPLITUDE:AMIN 0. V

---

## AMPLitude:AMIN?

Returns the minimum amplitude level set by the AMIN command.

**Related Commands:** AMPLitude:AMIN

**Syntax:** AMPLitude:AMIN?

**Example:** AMPLITUDE:AMIN?

**Response:** AMIN 0. V

---

## AMPLitude:BPFR

Selects the center frequency for the tunable bandpass filter when the Selective filter is selected. The HZ unit is optional.

**Related Commands:** AMPLitude:FILTER, AMPLitude:BPFR?

**Syntax:** AMPLitude:BPFR <nrf> [HZ]

**Factory Default:** 1000 HZ

**Example:** AMPLITUDE:BPFR 2500

---

**AMPLitude:BPFR?**

Returns the tunable bandpass filter center frequency.

**Related Commands:** AMPLitude:BPFR

**Syntax:** AMPLitude:BPFR?

**Example:** AMPLITUDE:BPFR?

**Response:** BPFR 2.5E+3 HZ;

---

**AMPLitude:EXTernal**

Selects glide or step settling in external sweep mode.

**Related Commands:** AMPLitude:STEPS, AMPLitude:EXTernal?

**Syntax:** AMPLitude:EXTernal { GLIDE | STEP }

**Factory Default:** GLIDE

**Example:** AMPLITUDE:EXTERNAL STEP

---

**AMPLitude:EXTernal?**

Returns the current external sweep settling mode.

**Related Commands:** AMPLitude:EXTernal

**Syntax:** AMPLitude:EXTernal?

**Example:** AMPLITUDE:EXTERNAL?

**Response:** EXTERNAL STEP;

---

**AMPLitude:FILTer**

Selects the filter for the Amplitude function, identical to the front-panel selection.

**Related Commands:** AMPLitude:BPFR, AMPLitude:WTD, AMPLitude:FILTer, AMPLitude:HPASs, AMPLitude:LPASs

**Factory Default:** UNWTD

**Syntax:** AMPLitude:FILTer { SElective | WTD | UNWTD }

**Example:** AMPLITUDE:FILTER WTD

---

**AMPLitude:FILTer?**

Returns the current filter for the Amplitude function.

**Related Commands:** AMPLitude:FILTer

**Syntax:** AMPLitude:FILTer?

**Example:** AMPLITUDE:FILTER?

**Response:** FILTER WTD;

---

## AMPLitude:FMAX

Selects the upper frequency display range for the sweep and bargraph displays. The frequency sweep step values will be computed using this value.

**Related Commands:** AMPLitude:FMIN, AMPLitude:FMAX?, GAMPLitude, GFREquency, WAVeform

**Syntax:** AMPLitude:FMAX <nrf> [ HZ ]

**Factory Default:** 20000 HZ

**Example:** AMPLITUDE:FMAX 22 KHZ

---

## AMPLitude:FMAX?

Returns the current upper frequency range setting for the sweep and bargraph displays.

**Related Commands:** AMPLitude:FMAX

**Syntax:** AMPLitude:FMAX?

**Example:** AMPLITUDE:FMAX?

**Response:** FMAX 22.E+3 HZ;

---

## AMPLitude:FMIN

Selects the lower frequency display range for the sweep and bargraph displays. The frequency sweep step values will be computed using this value.

**Related Commands:** AMPLitude:FMAX, AMPLitude:FMIN?, GAMPLitude, GFREquency, WAVeform

**Syntax:** AMPLitude:FMIN <nrf> [ HZ ]

**Factory Default:** 20

**Example:** AMPLITUDE:FMIN 100

---

## AMPLitude:FMIN?

Returns the current lower frequency range setting for the sweep and bargraph displays.

**Related Commands:** AMPLitude:FMIN

**Syntax:** AMPLitude:FMIN?

**Example:** AMPLITUDE:FMIN?

**Response:** FMIN 100. HZ;

---

## AMPLitude:HPASSs

Enables and disables the high pass filter. If ON, the frequency is 400 Hz. If OFF, the frequency is 10 Hz or 22 Hz if UNWTD filter is selected with BPASS set at either R22K or Q22K.

**Related Commands:** AMPLitude:FILTer, AMPLitude:LPASs, AMPLitude:HPASs?

**Syntax:** AMPLitude:HPASSs { ON | OFF }

**Factory Default:** OFF

**Example:** AMPLITUDE:HPASS ON

---

## AMPLitude:HPASSs?

Returns the current state of the high pass filter, ON or OFF.

**Related Commands:** AMPLitude:HPASSs  
**Syntax:** AMPLitude:HPASSs?  
**Example:** AMPLITUDE:HPASS?  
**Response:** HPASS ON;

---

## AMPLitude:LPASS

Selects the band pass filter when the unweighted filter is selected.

**Related Commands:** AMPLitude:FILTer, AMPLitude:HPASSs, AMPLitude:LPASSs?  
**Syntax:** AMPLitude:LPASSs { R22k | Q22k | R30k | R80k | R300k }  
**Factory Default:** R300K  
**Example:** AMPLITUDE:LPASS Q22K

---

## AMPLitude:LPASSs?

Returns the current band pass filter for the UNWTD filter.

**Related Commands:** AMPLitude LPASSs  
**Syntax:** AMPLitude:LPASSs?  
**Example:** AMPLITUDE:LPASS Q22K  
**Response:** LPASS Q22K;

---

## AMPLitude:MMAx

Selects the upper magnitude display range for the sweep and bargraph displays in currently selected units. The selected units will be the displayed units only if the bargraph or sweep is being displayed when this command is received.

**Related Commands:** AMPLitude:MMIN, AMPLitude:MMAx?  
**Syntax:** AMPLitude:MMAx <nrf> [ V | DBV | DBU | DBM | DBR | DBG | W ]  
**Factory Default:** 10 V  
**Example:** AMPLITUDE:MMAx 5 V

---

## AMPLitude:MMAx?

Returns the current upper magnitude range setting for the sweep and bargraph displays in currently selected units.

**Related Commands:** AMPLitude:MMAx  
**Syntax:** AMPLitude:MMAx?  
**Example:** AMPLITUDE:MMAx?  
**Response:** MMAx 5. V;

---

## AMPLitude:MMIN

Selects the lower magnitude display range for the sweep and bargraph displays. The selected units will be the displayed units only if the bargraph or sweep is being displayed when this command is received.

**Related Commands:** AMPLitude:MMAX, AMPLitude:MMIN?

**Syntax:** AMPLitude:MMIN <nrf> [ V | DBV | DBU | DBM | DBR | DBG | W ]

**Factory Default:** 1E-6 V

**Example:** AMPLITUDE:MMIN 0.02 V

---

## AMPLitude:MMIN?

Returns the current upper magnitude range setting for the sweep and bargraph displays in currently selected units.

**Related Commands:** AMPLitude:MMIN

**Syntax:** AMPLitude:MMIN?

**Example:** AMPLITUDE:MMIN?

**Response:** MMIN 20.E-3 V;

---

## AMPLitude:SET?

Returns the query responses for all the queries under the :AMPL: compound command header. The response is preceded by :DISP GPIB and followed by :DISPLAY *current\_display\_panel*. Equivalent to sending the following query string:

```
AMPLITUDE:AMAX?;AMIN?;BPFR?;EXTERNAL?;FILTER?;FMAX?;FMIN?;HPASS?;LPASS?;MMAX?;MMIN?;SPEED?;STEPS?;SWPTYPE?;UNIT?;WTD?;
```

**Related Commands:** All AMPLitude: queries

**Syntax:** AMPLitude:SET?

**Example:** AMPLITUDE:SET?

**Response:** :DISP GPIB;:AMPLITUDE:AMAX 1. V;AMIN 0. V;BPFR 1.E+3 HZ;EXTERNAL GLIDE;FILTER UNWTD;FMAX 20.E+3 HZ;FMIN 20. HZ;HPASS OFF;LPASS R300K;MMAX 10. V;MMIN 1.E-6 V;SPEED FAST;STEPS 0;SWPTYPE FREQ;UNIT V;WTD IECA;:DISPLAY PANEL;

---

## AMPLitude:SPEEd

Selects the sweep speed.

**Related Commands:** AMPLitude:SPEEd?

**Syntax:** AMPLitude:SPEEd { FAST | MEDium | SLOW }

**Factory Default:** FAST

**Example:** AMPLITUDE:SPEED MEDIUM

---

## AMPLitude:SPEed?

Returns the currently selected sweep speed.

**Related Commands:** AMPLitude:SPEed

**Syntax:** AMPLitude:SPEed?

**Example:** AMPLITUDE : SPEED?

**Response:** SPEED MEDIUM;

---

## AMPLitude:STEPS

Selects the sweep mode or the number of sweep steps. A step value of 0 selects the 1/3 octave frequency table if a frequency sweep is desired (SWPType is FREQ) or 2 dB steps if an amplitude sweep is desired (SWPType is AMPL). A step value of -1 selects the external sweep mode if SWPType is FREQ. All other values select the internal sweep mode with the indicated number of steps calculated using the FMIN and FMAX values for frequency sweeps and using the AMIN and AMAX values for amplitude sweeps. STEPs -1 (external sweep) is not permitted if SWPType is AMPL.

**Related Commands:** AMPLitude:EXTernal, AMPLitude:STEPS, AMPLitude:FMIN, AMPLitude:FMAX

**Syntax:** AMPLitude:STEPS { -1 | 0 | 3 | 5 | 10 | 15 | 30 | 75 | 150 }

**Factory Default:** 0

**Example:** AMPLITUDE : STEPS 3

---

## AMPLitude:STEPS?

Returns the selected sweep mode or the number of sweep steps selected for the internal sweep mode.

**Related Commands:** AMPLitude:STEPS

**Syntax:** AMPLitude:STEPS?

**Example:** AMPLITUDE : STEPS?

**Response:** STEPS 3;

---

## AMPLitude:SWPType

Specifies that either a frequency sweep or amplitude sweep is to be performed when the SWEEP START command is received. Amplitude sweeps and frequency sweeps proceed from high to low (from FMAX to FMIN and from AMAX to AMIN). The type of sweep is dependent on the currently selected generator (ANALOG, DIGITAL, or JITTER) and the currently selected measurement function. The currently displayed or last-selected generator will be used. SWPType AMPL is not permitted if STEPs is -1 (external sweep).

**Related Commands:** GENERator, DGENERator, and measurement function settings STEPs, FMAX, FMIN, AMAX, AMIN, EXTernal

**Syntax:** AMPLitude:SWPType { FREQ | AMPL }

**Factory Default:** FREQ

**Example:** AMPLitude:SWPType AMPL

---

## AMPLitude:SWPType?

Returns the setting of the sweep type, indicating that either a frequency sweep or amplitude sweep is to be performed when the SWEEP START command is received.

**Related Commands:** GENERator, DGENERator, and measurement function settings STEPs, FMAX, FMIN, AMAX, AMIN, EXTernal

**Syntax:** AMPLitude:SWPType?

**Example:** AMPLitude:SWPTYPE?

**Response:** SWPTYPE AMPL;

---

## AMPLitude:UNIT

Selects the measurement units for the Amplitude function.

**Related Commands:** REFDBR, REFDBM, REFWatt, AMPLitude:UNIT?

**Syntax:** AMPLitude:UNIT { V | DBV | DBU | DBM | DBR | DBG | W }

**Factory Default:** V

**Example:** AMPLITUDE:UNIT DBV

---

## AMPLitude:UNIT?

Returns the current units for the Amplitude function.

**Related Commands:** AMPLitude:UNIT

**Syntax:** AMPLitude:UNIT?

**Example:** AMPLITUDE:UNIT?

**Response:** UNIT DBV;

---

## AMPLitude:WTD

Selects the weighting filter for the Amplitude function when the WTD filter is selected. The choices are the same ones available from the front panel.

Note that the RMSCCIR filter choice is displayed as CCIR-1K.

**Related Commands:** AMPLitude:FILTer, AMPLitude:WTD?

**Syntax:** AMPLitude:WTD { AUX1 | AUX2 | IECA | RMSCcir | CCIR2K | QPKCcir | ARMCCir }

**Factory Default:** IECA

**Example:** AMPLITUDE:WTD RMSCCIR

---

## AMPLitude:WTD?

Returns the currently selected weighting filter for the Amplitude function.

**Related Commands:** AMPLitude:WTD

**Syntax:** AMPLitude:WTD?

**Example:** AMPLITUDE:WTD?

**Response:** WTD RMSCCIR;

---

## GENLoad:

Compound command header for the GENLOAD function measurement parameters. Note that sweeps of the GENLOAD measurement defaults to frequency sweeps.

---

### GENLoad:FMAX

Selects the upper frequency display range for the sweep and bargraph displays. Frequency sweep step values will be computed using this value.

**Related Commands:** GENLoad:FMIN, GENLoad:FMAX?, GAMplitude, GFREquency, WAVeform

**Syntax:** GENLoad:FMAX <nrf> [ HZ ]

**Factory Default:** 20000

**Example:** GENLOAD:FMAX 22000

---

### GENLoad:FMAX?

Returns the current upper frequency range setting for the sweep and bargraph displays.

**Related Commands:** GENLoad:FMAX

**Syntax:** GENLoad:FMAX?

**Example:** GENLOAD:FMAX?

**Response:** FMAX 2.2E+4 HZ;

---

### GENLoad:FMIN

Selects the lower frequency display range for the sweep and bargraph displays. The frequency sweep step values will be computed using this value.

**Related Commands:** GENLoad:FMAX, GENLoad:FMIN?, GAMplitude, GFREquency, WAVeform

**Syntax:** GENLoad:FMIN <nrf> [ HZ ]

**Factory Default:** 20

**Example:** GENLOAD:FMIN 100

---

### GENLoad:FMIN?

Returns the current lower frequency range setting for the sweep and bargraph displays.

**Related Commands:** GENLoad:FMIN

**Syntax:** GENLoad:FMIN?

**Example:** GENLOAD:FMIN?

**Response:** FMIN 100. HZ;

---

**GENLoad:MMAx**

Selects the upper magnitude display range for the sweep and bargraph displays in OHMS units.

**Related Commands:** GENLoad:MMIN, GENLoad:MMAx?

**Syntax:** GENLoad:MMAx <nrf>

**Factory Default:** 1000

**Example:** GENLOAD:MMAx 100

---

**GENLoad:MMAx?**

Returns the current upper magnitude range setting for the sweep and bargraph displays in OHMS units.

**Related Commands:** GENLoad:MMAx

**Syntax:** GENLoad:MMAx?

**Example:** GENLOAD:MMAx?

**Response:** MMAx 100. OHM;

---

**GENLoad:MMIN**

Selects the lower magnitude display range for the sweep and bargraph displays in OHMS units.

**Related Commands:** GENLoad:MMAx, GENLoad:MMIN?

**Syntax:** GENLoad:MMIN <nrf>

**Factory Default:** 0

**Example:** GENLOAD:MMIN 45

---

**GENLoad:MMIN?**

Returns the current upper magnitude range setting for the sweep and bargraph displays in OHMS units.

**Related Commands:** GENLoad:MMIN

**Syntax:** GENLoad:MMIN?

**Example:** GENLOAD:MMIN?

**Response:** MMIN 45. OHM;

---

**GENLoad:SET?**

Returns the query responses for all the queries under the :GENLOAD: compound command header. The response is preceded by :DISP GPIB and followed by :DISPLAY *current\_display\_panel*.

Equivalent to sending the following query string:

```
:GENLOAD:FMAx?;FMIN?;MMAx?;MMIN?;SPEED?;STEPS?;UNIT?;
```

**Related Commands:** All GENLoad: queries

**Syntax:** GENLoad:SET?

**Example:** GENLOAD:SET?

**Response:** :DISP GPIB;:GENLOAD:FMAx 20.E+3 HZ;FMIN 20. HZ;MMAx 1000. OHM;MMIN 0. OHM;SPEED FAST;STEPS 0;UNIT OHM;:DISPLAY PANEL;

---

## GENLoad:SPEEd

Selects the sweep speed.

**Related Commands:** GENLoad:SPEEd?

**Syntax:** GENLoad:SPEEd { FAST | MEDium | SLOW }

**Factory Default:** FAST

**Example:** GENLOAD : SPEED MEDIUM

---

## GENLoad:SPEEd?

Returns the currently selected sweep speed.

**Related Commands:** GENLoad SPEEd

**Syntax:** GENLoad:SPEEd?

**Example:** GENLOAD : SPEED?

**Response:** SPEED MEDIUM;

---

## GENLoad:STEPS

Selects the sweep mode and the number of sweep steps. Non-zero values select the internal sweep mode with the indicated number of steps calculated using the FMIN and FMAX values. A step value of 0 selects the 1/3 octave frequency table. External sweep mode is not supported for the GENLOAD function. Amplitude sweep mode is not supported for the GENLOAD function.

**Related Commands:** GENLoad:FMIN, GENLoad:FMAX, GENLoad:STEPS?

**Syntax:** GENLoad:STEPS { 0 | 3 | 5 | 10 | 15 | 30 | 75 | 150 }

**Factory Default:** 0

**Example:** GENLOAD : STEPS 10

---

## GENLoad:STEPS?

Returns the selected sweep mode and the number of sweep steps selected for the internal sweep mode.

**Related Commands:** GENLoad:STEPS

**Syntax:** GENLoad:STEPS?

**Example:** GENLOAD : STEPS?

**Response:** STEPS 10;

---

## GENLoad:UNIT

Selects the default OHM measurement units for the GENLOAD function. This command is included only for the sake of consistency and is not needed to specify OHM units.

**Related Commands:** GENLoad:UNIT?

**Syntax:** GENLoad:UNIT OHM

**Factory Default:** OHM

**Example:** GENLOAD : UNIT OHM

---

**GENLoad:UNIT?**

Returns the OHM units setting for the GENLOAD function.

**Related Commands:** GENLoad:UNIT

**Syntax:** GENLoad:UNIT?

**Example:** GENLOAD:UNIT?

**Response:** UNIT OHM;

---

## IMD:

Compound command header for the Intermodulation Distortion measurement function.

---

### IMD:AMAX

For the Access instrument, this command sets the maximum amplitude level for an amplitude sweep of the analog generator. For the Dual Domain instrument this command sets the maximum amplitude level for an amplitude sweep of the analog generator, the digital generator, or the jitter generator.

The numeric argument and its unit should be within the valid amplitude range of the generator and its waveform type. Thus for the Access instrument, the maximum level for an amplitude sweep will be the argument value and units for the analog generator. For the Dual Domain instrument, the maximum level for an amplitude sweep will be the argument value and units for the generator last selected with the GENERATOR command or selected by the user with the front panel OUTPUT button.

If the AMAX argument value is less than the current setting of the AMIN command but within the range of the generator, then the AMIN command setting will be coerced to a lower value and no error will be generated.

Error 4 “CONFLICT WITH MAXIMUM AMPLITUDE” will be generated if the argument is outside of the range of the generator.

For the Dual Domain instrument, set the generator type and unit before sending the AMAX command. Subsequent changes to the generator type may cause the AMAX setting to be changed.

See Section 1 General Information – Sweeps for more information about interactions between amplitude sweep parameters and changes of the currently selected generator.

**Related Commands:** IMD:AMIN, IMD:AMAX?

**Syntax:** IMD:AMAX <nrf> unit

**Factory Default:** 1.0 V

**Example:** IMD:AMAX 1. V

---

### IMD:AMAX?

Returns the maximum amplitude level set by the AMAX command.

**Related Commands:** IMD:AMAX

**Syntax:** IMD:AMAX?

**Example:** IMD:AMAX?

**Response:** AMAX 1. V;

---

## IMD:AMIN

For the Access instrument, this command sets the minimum amplitude level for an amplitude sweep of the analog generator. For the Dual Domain instrument this command sets the minimum amplitude level for an amplitude sweep of the analog generator, the digital generator, or the jitter generator.

The numeric argument and its unit should be within the valid amplitude range of the generator and its waveform type. Thus for the Access instrument, the minimum level for an amplitude sweep will be the argument value and units for the analog generator. For the Dual Domain instrument, the minimum level for an amplitude sweep will be the argument value and units for the generator last selected with the GENERator command or selected by the user with the front panel OUTPUT button.

If the AMIN argument value is greater than the current setting of the AMAX command but within the range of the generator, then the AMAX command setting will be coerced to a higher value and no error will be generated.

Error 5 “CONFLICT WITH MINIMUM AMPLITUDE” will be generated if the argument is outside of the range of the generator.

For the Dual Domain instrument, set the generator type and unit before sending the AMIN command with compatible units. Subsequent changes to the generator may cause the AMIN setting to be changed.

See Section 1 General Information – Sweeps for more information about interactions between amplitude sweep parameters and changes of the currently selected generator.

**Related Commands:** IMD:AMIN?, IMD:AMAX

**Syntax:** IMD:AMIN <nrf> unit

**Factory Default:** 0.0 V

**Example:** IMD:AMIN 0. V

---

## IMD:AMIN?

Returns the minimum amplitude level set by the AMIN command.

**Related Commands:** IMD:AMIN

**Syntax:** AMPLitude:AMIN?

**Example:** IMD:AMIN?

**Response:** AMIN 0. V;

---

## IMD:LUNit

Selects the level display units for the IMD measurement function. OFF turns the level measurement display off.

**Related Commands:** REFDBR, REFDBM, REFWatt, IMD:LUNit?

**Syntax:** IMD:LUNit { V | DBV | DBU | DBM | DBR | DBG | W | OFF }

**Factory Default:** V

**Example:** IMD:LUNIT DBU

---

**IMD:LUNit?**

Returns the currently selected level display units for the IMD measurement function.

**Related Commands:** IMD:LUNit  
**Syntax:** IMD:LUNit?  
**Example:** IMD:LUNIT?  
**Response:** LUNIT DBU;

---

**IMD:MMAx**

Selects the upper magnitude display range for the sweep and bargraph displays in currently selected units. The selected units will be the displayed units only if the bargraph or sweep is being displayed when this command is received.

**Related Commands:** IMD:MMIN, IMD:MMAx?  
**Syntax:** IMD:MMAx <nrf> [ PCT | DB ]  
**Factory Default:** 1 PCT  
**Example:** IMD:MMAx 5 PCT

---

**IMD:MMAx?**

Returns the current upper magnitude range setting for the sweep and bargraph displays in currently selected units.

**Related Commands:** IMD:MMAx  
**Syntax:** IMD:MMAx?  
**Example:** IMD:MMAx?  
**Response:** MMAx 5. PCT;

---

**IMD:MMIN**

Selects the lower magnitude display range for the sweep and bargraph displays. The selected units will be the displayed units only if the bargraph or sweep is being displayed when this command is received.

**Related Commands:** IMD:MMAx, IMD:MMIN?  
**Syntax:** IMD:MMIN <nrf> [ PCT | DB ]  
**Factory Default:** 0 PCT  
**Example:** IMD:MMIN -100 DB

---

**IMD:MMIN?**

Returns the current upper magnitude range setting for the sweep and bargraph displays in currently selected units.

**Related Commands:** IMD:MMIN  
**Syntax:** IMD:MMIN?  
**Example:** IMD:MMIN?  
**Response:** MMIN 0.001 PCT;      when IMD:UNIT set to PCT  
MMIN -100 DB;              when IMD:UNIT set to DB

---

## IMD:SET?

Returns the query responses for all the queries under the :IMD: compound command header. The response is preceded by :DISP GPIB and followed by :DISPLAY *current\_display\_panel*. Equivalent to sending the following query string:

```
IMD:AMAX?;AMIN?;LUNIT?;MMAX?;MMIN?;SPEED?:STEPS?;UNIT?;
```

**Related Commands:** All IMD: queries

**Syntax:** IMD:SET?

**Example:** IMD:SET?

**Response:** :DISP GPIB;:IMD:AMAX 1. V;AMIN 0. V;LUNIT V;MMAX 1. PCT;MMIN 0. PCT;SPEED FAST;STEPS 0;UNIT PCT;:DISPLAY PANEL;

---

## IMD:SPEEd

Selects the sweep speed.

**Related Commands:** IMD:SPEEd?

**Syntax:** IMD:SPEEd { FAST | MEDium | SLOW }

**Factory Default:** FAST

**Example:** IMD:SPEED MEDIUM

---

## IMD:SPEEd?

Returns the currently selected sweep speed.

**Related Commands:** IMD:SPEEd

**Syntax:** IMD:SPEEd?

**Example:** IMD:SPEED?

**Response:** SPEED MEDIUM;

---

## IMD:STEPS

Selects the sweep mode or the number of sweep steps. A step value of 0 selects 2 dB steps. All other values select the internal sweep mode with the indicated number of steps calculated using the AMIN and AMAX values for amplitude sweeps.

**Related Commands:** IMD:EXTernal, IMD:STEPS

**Syntax:** IMD:STEPS { 0 | 3 | 5 | 10 | 15 | 30 | 75 | 150 }

**Factory Default:** 0

**Example:** IMD:STEPS 3

---

**IMD:STEPS?**

Returns the selected sweep mode or the number of sweep steps selected for the internal sweep mode.

**Related Commands:** IMD:STEPS

**Syntax:** IMD:STEPS?

**Example:** IMD:STEPS?

**Response:** STEPS 3;

---

**IMD:UNIT**

Selects the IMD measurement units of percent or dB.

**Related Commands:** IMD:UNIT?

**Syntax:** IMD:UNIT { PCT | DB }

**Factory Default:** PCT

**Example:** IMD:UNIT DB

---

**IMD:UNIT?**

Returns the currently selected IMD measurement units.

**Related Commands:** IMD:UNIT

**Syntax:** IMD:UNIT?

**Example:** IMD:UNIT?

**Response:** UNIT DB;

---

## LEVel:

Compound command header for the Level measurement function.

---

### LEVel:AMAX

For the Access instrument, this command sets the maximum amplitude level for an amplitude sweep of the analog generator when the SWPType command is set to AMPL. For the Dual Domain instrument this command sets the maximum amplitude level for an amplitude sweep of the analog generator, the digital generator, or the jitter generator when the SWPType command is set to AMPL.

The numeric argument and its unit should be within the valid amplitude range of the generator and its waveform type. Thus for the Access instrument, the maximum level for an amplitude sweep will be the argument value and units for the analog generator. For the Dual Domain instrument, the maximum level for an amplitude sweep will be the argument value and units for the generator last selected with the GENerator command or selected by the user with the front panel OUTPUT button.

If the AMAX argument value is less than the current setting of the AMIN command but within the range of the generator, then the AMIN command setting will be coerced to a lower value and no error will be generated.

Error 4 “CONFLICT WITH MAXIMUM AMPLITUDE” will be generated if the argument is outside of the range of the generator.

For the Dual Domain instrument, set the generator type and unit before sending the AMAX command. Subsequent changes to the generator type may cause the AMAX setting to be changed.

See Section 1 General Information – Sweeps for more information about interactions between amplitude sweep parameters and changes of the currently selected generator.

**Related Commands:** LEVel:AMIN, LEVel:AMAX?, SWPType

**Syntax:** LEVel:AMAX <nrf> unit

**Factory Default:** 1.0 V

**Example:** LEVEL:AMAX 1. V

---

### LEVel:AMAX?

Returns the maximum amplitude level set by the AMAX command.

**Related Commands:** LEVel:AMAX

**Syntax:** LEVel:AMAX?

**Example:** LEVEL:AMAX?

**Response:** AMAX 1. V;

---

## LEVel:AMIN

For the Access instrument, this command sets the minimum amplitude level for an amplitude sweep of the analog generator when the SWPType command is set to AMPL. For the Dual Domain instrument this command sets the minimum amplitude level for an amplitude sweep of the analog generator, the digital generator, or the jitter generator when the SWPType command is set to AMPL.

The numeric argument and its unit should be within the valid amplitude range of the generator and its waveform type. Thus for the Access instrument, the minimum level for an amplitude sweep will be the argument value and units for the analog generator. For the Dual Domain instrument, the minimum level for an amplitude sweep will be the argument value and units for the generator last selected with the GENERator command or selected by the user with the front panel OUTPUT button.

If the AMIN argument value is greater than the current setting of the AMAX command but within the range of the generator, then the AMAX command setting will be coerced to a higher value and no error will be generated.

Error 5 “CONFLICT WITH MINIMUM AMPLITUDE” will be generated if the argument is outside of the range of the generator.

For the Dual Domain instrument, set the generator type and unit before sending the AMIN command with compatible units. Subsequent changes to the generator may cause the AMIN setting to be changed.

See Section 1 General Information – Sweeps for more information about interactions between amplitude sweep parameters and changes of the currently selected generator.

**Related Commands:** LEVel:AMIN?, LEVel:AMAX, SWPType

**Syntax:** LEVel:AMIN <nrf> unit

**Factory Default:** 0.0 V

**Example:** LEVEL:AMIN 0. V

---

## LEVel:AMIN?

Returns the minimum amplitude level set by the AMIN command.

**Related Commands:** LEVel:AMIN

**Syntax:** LEVel:AMIN?

**Example:** LEVEL:AMIN?

**Response:** AMIN 0. V;

---

## LEVel:EXtErnal

Selects glide or step settling in external sweep mode.

**Related Commands:** LEVel:STEPS, LEVel:EXtErnal?

**Syntax:** LEVel:EXtErnal { GLIDe | STEP }

**Factory Default:** GLIDE

**Example:** LEVEL:EXTERNAL STEP

---

**LEVel:EXtErnal?**

Returns the current external sweep settling mode.

**Related Commands:** LEVel:EXtErnal

**Syntax:** LEVel:EXtErnal?

**Example:** LEVEL:EXTERNAL?

**Response:** EXTERNAL STEP;

---

**LEVel:FMAX**

Selects the upper frequency display range for the sweep and bargraph displays. The frequency sweep step values will be computed using this value.

**Related Commands:** LEVel:FMIN, LEVel:FMAX?, GAMPlitude, GFREquency, WAVeform

**Syntax:** LEVel:FMAX <nrf> [ HZ ]

**Factory Default:** 20000 HZ

**Example:** LEVEL:FMAX 22E+3 HZ

---

**LEVel:FMAX?**

Returns the current upper frequency range setting for the sweep and bargraph displays.

**Related Commands:** LEVel:FMAX

**Syntax:** LEVel:FMAX?

**Example:** LEVEL:FMAX?

**Response:** FMAX 2.2E+4 HZ;

---

**LEVel:FMIN**

Selects the lower frequency display range for the sweep and bargraph displays. The frequency sweep step values will be computed using this value.

**Related Commands:** LEVel:FMAX, LEVel:FMIN?, GAMPlitude, GFREquency, WAVeform

**Syntax:** LEVel:FMIN <nrf> [ HZ ]

**Factory Default:** 20 HZ

**Example:** LEVEL:FMIN 100 HZ

---

**LEVel:FMIN?**

Returns the current lower frequency range setting for the sweep and bargraph displays.

**Related Commands:** LEVel:FMin

**Syntax:** LEVel:FMIN?

**Example:** LEVEL:FMIN?

**Response:** FMIN 100. HZ;

---

## LEVel:LUNit

Selects the measurement units for the second channel of the level function for the level meter :M2? query response.

**Related Commands:** REFDBR, REFDBM, REFWatt

**Syntax:** LEVel:LUNit { V | DBV | DBU | DBM | DBR | DBG | W }

**Factory Default:** V

**Example:** LEVEL:LUNIT DBV

---

## LEVel:LUNit?

Returns the selected units for the second channel level measurement function.

**Related Commands:** LEVel:LUNit

**Syntax:** LEVel:LUNit?

**Example:** LEVEL:LUNIT?

**Response:** LUNIT DBV;

---

## LEVel:MMAx

Selects the upper magnitude display range for the sweep and bargraph displays in currently selected units. The selected units will be the displayed units only if the bargraph or sweep is being displayed when this command is received.

**Related Commands:** LEVel:MMIN, LEVel:MMAx?

**Syntax:** LEVel:MMAx <nrf> [ V | DBV | DBU | DBM | DBR | DBG | W ]

**Factory Default:** 10 V

**Example:** LEVEL:MMAx 5 DBU

---

## LEVel:MMAx?

Returns the current upper magnitude range setting for the sweep and bargraph displays in currently selected units.

**Related Commands:** LEVel:MMAx

**Syntax:** LEVel:MMAx?

**Example:** LEVEL:MMAx?

**Response:** MMAx 1.377 V;

---

## LEVel:MMIN

Selects the lower magnitude display range for the sweep and bargraph displays. The selected units will be the displayed units only if the bargraph or sweep is being displayed when this command is received.

**Related Commands:** LEVel:MMAx, LEVel:MMIN?

**Syntax:** LEVel:MMIN <nrf> [ V | DBV | DBU | DBM | DBR | DBG | W ]

**Factory Default:** 1. E-6 V

**Example:** LEVEL:MMIN 1 DBU

---

**LEVel:MMIN?**

Returns the current upper magnitude range setting for the sweep and bargraph displays in currently selected units.

**Related Commands:** LEVel:MMIN  
**Syntax:** LEVel:MMIN?  
**Example:** LEVEL:MMIN?  
**Response:** MMIN 869.E-3 V;

---

**LEVel:SET?**

Returns the query responses for all the queries under the :LEVEL: compound command header. The response is preceded by :DISP GPIB and followed by :DISPLAY *current\_display\_panel*. Equivalent to sending the following query string:  
 LEVEL:AMAX?;AMIN?;EXTERNAL?;FMAX?;FMIN?;LUNIT?;MMAX?;MMIN?;SPEED?;STEPS?;SWPTYPE?;UNIT?;

**Related Commands:** All LEVel: queries  
**Syntax:** LEVel:SET?  
**Example:** LEVEL:SET?  
**Response:** :DISP GPIB;:LEVEL:AMAX 1. V;AMIN 0. V;EXTERNAL GLIDE;FMAX 20.E+3 HZ;FMIN 20. HZ;LUNIT V;MMAX 10. V;MMIN 1.E-6 V;SPEED FAST;STEPS 0;SWPTYPE FREQ;UNIT V;:DISPLAY PANEL;

---

**LEVel:SPEEd**

Selects the sweep speed.

**Related Commands:** LEVel:SPEEd?  
**Syntax:** LEVel:SPEEd { FAST | MEDium | SLOW }  
**Factory Default:** FAST  
**Example:** LEVEL:SPEED SLOW

---

**LEVel:SPEEd?**

Returns the currently selected sweep speed.

**Related Commands:** LEVel:SPEEd  
**Syntax:** LEVel:SPEEd?  
**Example:** LEVEL:SPEED?  
**Response:** SPEED SLOW;

---

## LEVel:STEPS

Selects the sweep mode or the number of sweep steps. A step value of 0 selects the 1/3 octave frequency table if a frequency sweep is desired (SWPType is FREQ) or 2 dB steps if an amplitude sweep is desired (SWPType is AMPL). A step value of -1 selects the external sweep mode if SWPType is FREQ. All other values select the internal sweep mode with the indicated number of steps calculated using the FMIN and FMAX values for frequency sweeps and using the AMIN and AMAX values for amplitude sweeps. STEPs -1 (external sweep) is not permitted if SWPType is AMPL.

**Related Commands:** LEVel:EXtErnal, LEVel:FMIN, LEVel:FMAX, LEVel:STEPS?

**Syntax:** LEVel:STEPS { -1 | 0 | 3 | 5 | 10 | 15 | 30 | 75 }

**Factory Default:** 0

**Example:** LEVEL:STEPS 10

---

## LEVel:STEPS?

Returns the selected sweep mode or the number of sweep steps selected for the internal sweep mode.

**Related Commands:** LEVel STEPs

**Syntax:** LEVel:STEPS?

**Example:** LEVEL:STEPS?

**Response:** STEPS 10;

---

## LEVel:SWPType

Specifies that either a frequency sweep or amplitude sweep is to be performed when the SWEEP START command is received. Amplitude sweeps and frequency sweeps proceed from high to low (from FMAX to FMIN and from AMIN to AMAX). The type of sweep is dependent on the currently selected generator (ANALOG, DIGITAL, or JITTER) and the currently selected measurement function. The currently displayed or last-selected generator will be used. SWPType AMPL is not permitted if STEPs is -1 (external sweep).

**Related Commands:** GENerator, DGENerator, and measurement function settings STEPs, FMAX, FMIN, AMAX, AMIN, EXtErnal

**Syntax:** LEVel:SWPType { FREQ | AMPL }

**Factory Default:** FREQ

**Example:** LEVel:SWPType AMPL

---

## LEVel:SWPType?

Returns the setting of the sweep type, indicating that either a frequency sweep or amplitude sweep is to be performed when the SWEEP START command is received.

**Related Commands:** GENerator, DGENerator, and measurement function settings STEPs, FMAX, FMIN, AMAX, AMIN, EXtErnal

**Syntax:** LEVel:SWPType?

**Example:** LEVel:SWPType?

**Response:** SWPType AMPL

---

**LEVel:UNIT**

Selects the measurement units for the first channel of the level function for the function meter :M1? query response.

**Related Commands:** REFDBR, REFDBM, REFWatt, LEVel:UNIT?

**Syntax:** LEVel:UNIT { V | DBV | DBU | DBM | DBR | DBG | W }

**Factory Default:** V

**Example:** LEVEL:UNIT DBV

---

**LEVel:UNIT?**

Returns the selected units for the first channel of the level measurement function.

**Related Commands:** LEVel:UNIT

**Syntax:** LEVel:UNIT?

**Example:** LEVEL:UNIT?

**Response:** UNIT DBV;

---

## NOISe:

Compound command header for the Noise measurement function.

---

### NOISe:AMAX

For the Access instrument, this command sets the maximum amplitude level for an amplitude sweep of the analog generator when the SWPType command is set to AMPL. For the Dual Domain instrument this command sets the maximum amplitude level for an amplitude sweep of the analog generator, the digital generator, or the jitter generator when the SWPType command is set to AMPL.

The numeric argument and its unit should be within the valid amplitude range of the generator and its waveform type. Thus for the Access instrument, the maximum level for an amplitude sweep will be the argument value and units for the analog generator. For the Dual Domain instrument, the maximum level for an amplitude sweep will be the argument value and units for the generator last selected with the GENERator command or selected by the user with the front panel OUTPUT button.

If the AMAX argument value is less than the current setting of the AMIN command but within the range of the generator, then the AMIN command setting will be coerced to a lower value and no error will be generated.

Error 4 “CONFLICT WITH MAXIMUM AMPLITUDE” will be generated if the argument is outside of the range of the generator.

For the Dual Domain instrument, set the generator type and unit before sending the AMAX command. Subsequent changes to the generator type may cause the AMAX setting to be changed.

See Section 1 General Information – Sweeps for more information about interactions between amplitude sweep parameters and changes of the currently selected generator.

**Related Commands:** NOISe:AMIN, NOISe:AMAX?, SWPType

**Syntax:** NOISe:AMAX <nrf> unit

**Factory Default:** 1.0 V

**Example:** NOISE:AMAX 1. V

---

### NOISe:AMAX?

Returns the maximum amplitude level set by the AMAX command.

**Related Commands:** NOISe:AMAX

**Syntax:** NOISe:AMAX?

**Example:** NOISE:AMAX?

**Response:** AMAX 1. V;

---

## NOISE:AMIN

For the Access instrument, this command sets the minimum amplitude level for an amplitude sweep of the analog generator when the SWPType command is set to AMPL. For the Dual Domain instrument this command sets the minimum amplitude level for an amplitude sweep of the analog generator, the digital generator, or the jitter generator when the SWPType command is set to AMPL.

The numeric argument and its unit should be within the valid amplitude range of the generator and its waveform type. Thus for the Access instrument, the minimum level for an amplitude sweep will be the argument value and units for the analog generator. For the Dual Domain instrument, the minimum level for an amplitude sweep will be the argument value and units for the generator last selected with the GENERator command or selected by the user with the front panel OUTPUT button.

If the AMIN argument value is greater than the current setting of the AMAX command but within the range of the generator, then the AMAX command setting will be coerced to a higher value and no error will be generated.

Error 5 “CONFLICT WITH MINIMUM AMPLITUDE” will be generated if the argument is outside of the range of the generator.

For the Dual Domain instrument, set the generator type and unit before sending the AMIN command with compatible units. Subsequent changes to the generator may cause the AMIN setting to be changed.

See Section 1 General Information – Sweeps for more information about interactions between amplitude sweep parameters and changes of the currently selected generator.

**Related Commands:** NOISE:AMIN?, NOISE:AMAX, SWPType

**Syntax:** NOISE:AMIN <nrf> unit

**Factory Default:** 0.0 V

**Example:** NOISE:AMIN 0. V

---

## NOISE:AMIN?

Returns the minimum amplitude level set by the AMIN command.

**Related Commands:** NOISE:AMIN

**Syntax:** NOISE:AMIN?

**Example:** NOISE:AMIN?

**Response:** AMIN 0. V;

---

## NOISE:BPFR

Selects the center frequency for the tunable bandpass filter when the Selective filter is selected. The HZ unit is optional.

**Related Commands:** NOISE:FILTer, NOISE:BPFR?

**Syntax:** NOISE:BPFR <nrf> [ HZ ]

**Factory Default:** 1000 HZ

**Example:** NOISE:BPFR 2500

---

**NOISe:BPFR?**

Returns the tunable bandpass filter center frequency.

**Related Commands:** NOISe:BPFR

**Syntax:** NOISe:BPFR?

**Example:** NOISE:BPFR?

**Response:** BPFR 2.5E+3 HZ;

---

**NOISe:EXtErnal**

Selects glide or step settling in external sweep mode.

**Related Commands:** NOISe:STEPs, NOISe:EXtErnal?

**Syntax:** NOISe:EXtErnal { GLIDe | STEP }

**Factory Default:** GLIDE

**Example:** NOISE:EXTERNAL STEP

---

**NOISe:EXtErnal?**

Returns the current external sweep settling mode.

**Related Commands:** NOISe:EXtErnal

**Syntax:** NOISe:EXtErnal?

**Example:** NOISE:EXTERNAL?

**Response:** EXTERNAL STEP;

---

**NOISe:FiLTeR**

Selects the filter for the Noise function, identical to the front-panel selection.

**Related Commands:** NOISe:BPFR, NOISe:WTD, NOISe:FiLTeR?, NOISe:HPASs, NOISe:LPASs

**Syntax:** NOISe:FiLTeR { SElective | WTD | UNWTD }

**Factory Default:** UNWTD

**Example:** NOISE:FILTER SELECTIVE

---

**NOISe:FiLTeR?**

Returns the current filter for the Noise function.

**Related Commands:** NOISe:FiLTeR

**Syntax:** NOISe:FiLTeR?

**Example:** NOISE:FILTER?

**Response:** FILTER SELECTIVE;

---

## NOISe:FMAX

Selects the upper frequency display range for the sweep and bargraph displays. The frequency sweep step values will be computed using this value.

**Related Commands:** NOISe:FMIN, NOISe:FMAX?, GAMplitude, GFREquency, WAVEform

**Syntax:** NOISe:FMAX <nrf> [ HZ ]

**Factory Default:** 20000 HZ

**Example:** NOISE:FMAX 22000

---

## NOISe:FMAX?

Returns the current upper frequency range setting for the sweep and bargraph displays.

**Related Commands:** NOISe:FMAX

**Syntax:** NOISe:FMAX?

**Example:** NOISE:FMAX?

**Response:** FMAX 22.E+3 HZ;

---

## NOISe:FMIN

Selects the lower frequency display range for the sweep and bargraph displays. The frequency sweep step values will be computed using this value.

**Related Commands:** NOISe:FMAX, NOISe:FMIN?, GAMplitude, GFREquency, WAVEform

**Syntax:** NOISe:FMIN <nrf> [ HZ ]

**Factory Default:** 20 HZ

**Example:** NOISE:FMIN 100

---

## NOISe:FMIN?

Returns the current lower frequency range setting for the sweep and bargraph displays.

**Related Commands:** NOISe:FMIN

**Syntax:** NOISe:FMIN?

**Example:** NOISE:FMIN?

**Response:** FMIN 100. HZ;

---

## NOISe:HPASS

Enables and disables the high pass filter. If ON, the frequency is 400 Hz. If OFF, the frequency is 10 Hz or 22 Hz if UNWTD filter is selected with BPASS set at either R22K or Q22K.

**Related Commands:** NOISe:FILTer, NOISe:LPASs, NOISe:HPASs?

**Syntax:** NOISe:HPASs { ON | OFF }

**Factory Default:** OFF

**Example:** NOISE:HPASS ON

---

**NOISe:HPASs?**

Returns the current state of the high pass filter, ON or OFF.

**Related Commands:** NOISe:HPASs

**Syntax:** NOISe:HPASs?

**Example:** NOISE:HPASS?

**Response:** HPASS ON;

---

**NOISe:LPASS**

Selects the band pass filter when the unweighted filter is selected.

**Related Commands:** NOISe:FILTER, NOISe:HPASs, NOISe:LPASs?

**Syntax:** NOISe:LPASs { R22k | Q22k | R30k | R80k | R300k }

**Factory Default:** R80K

**Example:** NOISE:LPASS R300K

---

**NOISe:LPASS?**

Returns the current band pass filter for the UNWTD filter.

**Related Commands:** NOISe:LPASs

**Syntax:** NOISe:LPASs?

**Example:** NOISE:LPASS?

**Response:** LPASS R300K;

---

**NOISe:MMAx**

Selects the upper magnitude display range for the sweep and bargraph displays in currently selected units. The selected units will be the displayed units only if the bargraph or sweep is being displayed when this command is received.

**Related Commands:** NOISe:MMIN, NOISe:MMAx?

**Syntax:** NOISe:MMAx <nrf> [ V | DBV | DBU | DBM | DBR | DBG | W | DB ]

**Factory Default:** 10 V

**Example:** NOISE:MMAx -50 DBU

---

**NOISe:MMAx?**

Returns the current upper magnitude range setting for the sweep and bargraph displays in currently selected units.

**Related Commands:** NOISe:MMAx

**Syntax:** NOISe:MMAx?

**Example:** NOISE:MMAx?

**Response:** MMAx -50 DBU;           when UNIT set to DBU  
MMAx 2.449E-3 V;           when UNIT set to V

---

## NOISE:MMIN

Selects the lower magnitude display range for the sweep and bargraph displays. The selected units will be the displayed units only if the bargraph or sweep is being displayed when this command is received.

**Related Commands:** NOISE:MMAx, NOISE:MMIN?

**Syntax:** NOISE:MMIN <nrf> [ V | DBV | DBU | DBM | DBR | DBG | W | DB ]

**Factory Default:** 1.0E-6 V

**Example:** NOISE:MMIN -60 DBV

---

## NOISE:MMIN?

Returns the current upper magnitude range setting for the sweep and bargraph displays in currently selected units.

**Related Commands:** NOISE:MMAx, NOISE:MMIN?

**Syntax:** NOISE:MMIN?

**Example:** NOISE:MMIN?

**Response:** MMIN -60 DBV;

---

## NOISE:SET?

Returns the query responses for all the queries under the :NOISE: compound command header. The response is preceded by :DISP GPIB and followed by :DISPLAY *current\_display\_panel*. Equivalent to sending the following query string:

```
NOISE:AMAX?;AMIN?;BPFR?;EXTERNAL?;FILTER?;FMAX?;
FMIN?;HPASS?;LPASS?;MMAx?;MMIN?;SPEED?;STEPS?;SW
PTYPE;UNIT?;WTD?;
```

**Related Commands:** All NOISE: queries

**Syntax:** NOISE:SET?

**Example:** NOISE:SET?

**Response:** :DISP GPIB;:NOISE:AMAX 1. V;AMIN 0. V;BPFR 1.E+3 HZ;EXTERNAL GLIDE;FILTER UNWTD;FMAX 20.E+3 HZ;FMIN 20. HZ;HPASS OFF;LPASS R80K;MMAx 10. V;MMIN 1.E-6 V;SPEED FAST;STEPS 0;SWPTYPE FREQ;UNIT V;WTD IECA;:DISPLAY PANEL;

---

## NOISE:SPEEd

Selects the sweep speed.

**Related Commands:** NOISE:SPEEd

**Syntax:** NOISE:SPEEd { FAST | MEDium | SLOW }

**Factory Default:** FAST

**Example:** NOISE:SPEED MEDIUM

---

## NOISe:SPEEd?

Returns the currently selected sweep speed.

**Related Commands:** NOISe:SPEEd  
**Syntax:** NOISe:SPEEd?  
**Example:** NOISE :SPEED?  
**Response:** SPEED MEDIUM

---

## NOISe:STEPS

Selects the sweep mode or the number of sweep steps. A step value of 0 selects the 1/3 octave frequency table if a frequency sweep is desired (SWPType is FREQ) or 2 dB steps if an amplitude sweep is desired (SWPType is AMPL). A step value of -1 selects the external sweep mode if SWPType is FREQ. All other values select the internal sweep mode with the indicated number of steps calculated using the FMIN and FMAX values for frequency sweeps and using the AMIN and AMAX values for amplitude sweeps. STEPs -1 (external sweep) is not permitted if SWPType is AMPL.

**Related Commands:** NOISe:EXtErnal, NOISe:STEPS, NOISe:FMIN, NOISe:FMAX  
**Syntax:** NOISe:STEPS { -1 | 0 | 3 | 5 | 10 | 15 | 30 | 75 | 150 }  
**Factory Default:** 0  
**Example:** NOISE :STEPS 30

---

## NOISe:STEPS?

Returns the selected sweep mode or the number of sweep steps selected for the internal sweep mode.

**Related Commands:** NOISe:STEPS  
**Syntax:** NOISe:STEPS?  
**Example:** NOISE :STEPS?  
**Response:** STEPS 30;

---

## NOISe:SWPType

Specifies that either a frequency sweep or amplitude sweep is to be performed when the SWEEP START command is received. Amplitude sweeps and frequency sweeps proceed from high to low (from FMAX to FMIN and from AMIN to AMAX). The type of sweep is dependent on the currently selected generator (ANALOG, DIGITAL, or JITTER) and the currently selected measurement function. The currently displayed or last-selected generator will be used. SWPType AMPL is not permitted if STEPs is -1 (external sweep).

**Related Commands:** GENerator, DGENerator, and measurement function settings STEPs, FMAX, FMIN, AMAX, AMIN, EXtErnal  
**Syntax:** NOISe:SWPType { FREQ | AMPL }  
**Factory Default:** FREQ  
**Example:** NOISe:SWPTYPE AMPL

---

**NOISe:SWPTType?**

Returns the setting of the sweep type, indicating that either a frequency sweep or amplitude sweep is to be performed when the SWEEP START command is received.

**Related Commands:** GENERator, DGENERator, and measurement function settings STEPs, FMAX, FMIN, AMAX, AMIN, EXTernal

**Syntax:** NOISe:SWPTType?

**Example:** NOISe:SWPTYPE?

**Response:** SWPTYPE AMPL;

---

**NOISe:UNIT**

Selects the measurement units for the Noise function. The DB unit selects the Signal to Noise (S/N) Ratio mode which cycles the Generator output on and off to measure the ratio of signal level with generator on to the signal with the generator off and the output back-terminated.

**Related Commands:** OUTput, REFDBM, REFDBR, REF:WATT, NOISe:UNIT?

**Syntax:** NOISe:UNIT { V | DBV | DBU | DBM | DBG | W | DB }

**Factory Default:** V

**Example:** NOISe:UNIT DBM

---

**NOISe:UNIT?**

Returns the current units for the Noise function.

**Related Commands:** NOISe:UNIT

**Syntax:** NOISe:UNIT?

**Example:** NOISe:UNIT?

**Response:** UNIT DBM;

---

**NOISe:WTD**

Selects the weighting filter for the Noise function when the WTD filter is selected. The choices are the same ones available from the front panel.

Note that the RMSCCIR filter choice is displayed on the front panel as CCIR-1K.

**Related Commands:** NOISe:FILTer, NOISe:WTD

**Syntax:** NOISe:WTD { AUX1 | AUX2 | IECA | RMSCcir | CCIR2K | QPKCcir | ARMCCcir }

**Factory Default:** IECA

**Example:** NOISe:WTD ARMCCIR

---

**NOISe:WTD?**

Returns the currently selected weighting filter for the Noise function.

**Related Commands:** NOISe WTD

**Syntax:** NOISe:WTD?

**Example:** NOISe:WTD?

**Response:** WTD ARMCCIR;

---

## PHASe:

Compound command header for the Phase measurement function.

---

### PHASe:AMAX

For the Access instrument, this command sets the maximum amplitude level for an amplitude sweep of the analog generator when the SWPType command is set to AMPL. For the Dual Domain instrument this command sets the maximum amplitude level for an amplitude sweep of the analog generator, the digital generator, or the jitter generator when the SWPType command is set to AMPL.

The numeric argument and its unit should be within the valid amplitude range of the generator and its waveform type. Thus for the Access instrument, the maximum level for an amplitude sweep will be the argument value and units for the analog generator. For the Dual Domain instrument, the maximum level for an amplitude sweep will be the argument value and units for the generator last selected with the GENERator command or selected by the user with the front panel OUTPUT button.

If the AMAX argument value is less than the current setting of the AMIN command but within the range of the generator, then the AMIN command setting will be coerced to a lower value and no error will be generated.

Error 4 “CONFLICT WITH MAXIMUM AMPLITUDE” will be generated if the argument is outside of the range of the generator.

For the Dual Domain instrument, set the generator type and unit before sending the AMAX command. Subsequent changes to the generator type may cause the AMAX setting to be changed.

See Section 1 General Information – Sweeps for more information about interactions between amplitude sweep parameters and changes of the currently selected generator.

**Related Commands:** PHASe:AMIN, PHASe:AMAX?, SWPType

**Syntax:** PHASe:AMAX <nrf> unit

**Factory Default:** 1.0 V

**Example:** PHASe:AMAX 1. V

---

### PHASe:AMAX?

Returns the maximum amplitude level set by the AMAX command.

**Related Commands:** PHASe:AMAX

**Syntax:** PHASe:AMAX?

**Example:** PHASe:AMAX?

**Response:** AMAX 1. V;

---

### PHASe:AMIN

For the Access instrument, this command sets the minimum amplitude level for an amplitude sweep of the analog generator when the SWPType command is set to AMPL. For the Dual Domain instrument this command sets the minimum amplitude level for an amplitude sweep of the analog generator, the digital generator, or the jitter generator when the SWPType command is set to AMPL.

The numeric argument and its unit should be within the valid amplitude range of the generator and its waveform type. Thus for the Access instrument, the minimum level for an amplitude sweep will be the argument value and units for the analog generator. For the Dual Domain instrument, the minimum level for an amplitude sweep will be the argument value and units for the generator last selected with the GENERator command or selected by the user with the front panel OUTPUT button.

If the AMIN argument value is greater than the current setting of the AMAX command but within the range of the generator, then the AMAX command setting will be coerced to a higher value and no error will be generated.

Error 5 “CONFLICT WITH MINIMUM AMPLITUDE” will be generated if the argument is outside of the range of the generator.

For the Dual Domain instrument, set the generator type and unit before sending the AMIN command with compatible units. Subsequent changes to the generator may cause the AMIN setting to be changed.

See Section 1 General Information – Sweeps for more information about interactions between amplitude sweep parameters and changes of the currently selected generator.

**Related Commands:** PHASe:AMIN?, PHASe:AMAX, SWPType

**Syntax:** PHASe:AMIN <nrf> unit

**Factory Default:** 0.0 V

**Example:** PHASE:AMIN 0. V

## PHASe:AMIN?

Returns the minimum amplitude level set by the AMIN command.

**Related Commands:** PHASe:AMIN

**Syntax:** PHASe:AMIN?

**Example:** PHASE:AMIN?

**Response:** AMIN 0. V;

## PHASe:AVERage

Selects the averaging function for the Phase meter.

**Related Commands:** PHASe:AVERage?

**Syntax:** PHASe:AVERage { AVERage | NOAVERage }

**Factory Default:** NOAVERAGE

**Example:** PHASE:AVERAGE AVERAGE

## PHASe:AVERage?

Returns the status of the Phase meter averaging function, ON or OFF.

**Related Commands:** PHASe:AVERage?

**Syntax:** PHASe:AVERage?

**Example:** PHASE:AVERAGE?

**Response:** AVERAGE AVERAGE;

---

## PHASe:EXtErnal

Selects glide or step settling in external sweep mode.

**Related Commands:** PHASe:STEPs, PHASe:EXtErnal?

**Syntax:** PHASe:EXtErnal { GLIDe | STEP }

**Factory Default:** GLIDE

**Example:** PHASe:EXtErnal STEP

---

## PHASe:EXtErnal?

Returns the current external sweep settling mode.

**Related Commands:** PHASe:EXtErnal

**Syntax:** PHASe:EXtErnal?

**Example:** PHASe:EXtErnal?

**Response:** EXtErnal STEP;

---

## PHASe:FMAX

Selects the upper frequency display range for the sweep and bargraph displays. The frequency sweep step values will be computed using this value.

**Related Commands:** PHASe:FMIN, PHASe:FMAX?, GAMPlitude, GFREquency, WAVeform

**Syntax:** PHASe:FMAX <nrf> [ HZ ]

**Factory Default:** 20000 HZ

**Example:** PHASe:FMAX 16K HZ

---

## PHASe:FMAX?

Returns the current upper frequency range setting for the sweep and bargraph displays.

**Related Commands:** PHASe:FMAX

**Syntax:** PHASe:FMAX?

**Example:** PHASe:FMAX?

**Response:** FMAX 16E+3 HZ;

---

## PHASe:FMIN

Selects the lower frequency display range for the sweep and bargraph displays. The frequency sweep step values will be computed using this value.

**Related Commands:** PHASe:FMAX, PHASe:FMIN?, GAMPlitude, GFREquency, WAVeform

**Syntax:** PHASe:FMIN <nrf> [ HZ ]

**Factory Default:** 20 HZ

**Example:** PHASe:FMIN 2E+2 HZ

---

**PHASe:FMIN?**

Returns the current lower frequency range setting for the sweep and bargraph displays.

**Related Commands:** PHASe:FMIN  
**Syntax:** PHASe:FMIN?  
**Example:** PHASE:FMIN?  
**Response:** FMIN 200 HZ;

---

**PHASe:LUNit**

Selects the Level meter units. OFF turns the level measurement display off.

**Related Commands:** PHASe:LUNit:, REFDBR, REFDBM, REFWatt  
**Syntax:** PHASe:LUNit { V | DBV | DBU | DBM | DBR | DBG | W | OFF }  
**Factory Default:** V  
**Example:** PHASE:LUNIT DBG

---

**PHASe:LUNit?**

Returns the currently selected Level meter units.

**Related Commands:** PHASe:LUNit  
**Syntax:** PHASe:LUNit?  
**Example:** PHASE:LUNIT?  
**Response:** LUNIT DBG;

---

**PHASe:MMAx**

Selects the upper magnitude display range for the sweep and bargraph displays. DEG units are optional.

**Related Commands:** PHASe:MMIN, PHASe:MMAx?  
**Syntax:** PHASe:MMAx <nrf> [ DEG ]  
**Factory Default:** +180 DEG  
**Example:** PHASE:MMAx 170 DEG

---

**PHASe:MMAx?**

Returns the current upper magnitude range setting for the sweep and bargraph displays in currently selected units.

**Related Commands:** PHASe:MMAx  
**Syntax:** PHASe:MMAx <nrf> [ DEG ]  
**Example:** PHASE:MMAx?  
**Response:** MMAx 170 DEG;

---

**PHASe:MMIN**

Selects the lower magnitude display range for the sweep and bargraph displays. DEG units are optional.

**Related Commands:** PHASe:MMAx, PHASe:MMIN?

**Syntax:** PHASe:MMIN <nrf> [ DEG ]

**Factory Default:** -180 DEG

**Example:** PHASe:MMIN 100

---

**PHASe:MMIN?**

Returns the current upper magnitude range setting for the sweep and bargraph displays in currently selected units.

**Related Commands:** PHASe:MMIN

**Syntax:** PHASe:MMIN?

**Example:** PHASe:MMIN?

**Response:** MMIN -100 DEG;

---

**PHASe:RANGE**

Selects the Phase meter display range. DEG90 specifies the –270/+90 range. DEG180 specifies the –180/+180 range. DEG270 specifies the –90/+270 range.

**Related Commands:** PHASe:RANGe?

**Syntax:** PHASe:RANGe { DEG90 | DEG180 | DEG270 }

**Factory Default:** DEG270

**Example:** :PHASe:RANGE DEG90

---

**PHASe:RANGe?**

Returns the Phase meter display range.

**Related Commands:** PHASe:RANGe

**Syntax:** PHASe:RANGe?

**Example:** PHASe:RANGe?

**Response:** RANGE DEG90;

---

**PHASe:SET?**

Returns the query responses for all the queries under the :PHASe: compound command header. The response is preceded by :DISP GPIB and followed by :DISPLAY *current\_display\_panel*. Equivalent to sending the following query string:

```
PHASe:AMAX?;AMIN?;AVERAGE?;EXTERNAL?;FMAX?;FMIN?;LUNIT?;MMAx?;MMIN?;RANGE?;SPEED?;STEPS?;SWPTYPE?;UNIT?;
```

**Related Commands:** All PHASe: queries

**Syntax:** PHASe:SET?

**Example:** PHASe:SET?

**Response:** :DISP GPIB;:PHASe:AMAX 1. V;AMIN 0. V;AVERAGE  
NOAVERAGE;EXTERNAL GLIDE;FMAX 20.E+3 HZ;FMIN 20.  
HZ;LUNIT V;MMAX 180. DEG;MMIN -180. DEG;RANGE  
DEG270;SPEED FAST;STEPs 0;SWPTYPE FREQ;UNIT  
DEG;:DISPLAY PANEL;

---

## PHASe:SPEEd

Selects the sweep speed.

**Related Commands:** PHASe:SPEEd?

**Syntax:** PHASe:SPEEd { FAST | MEDium | SLOW }

**Factory Default:** FAST

**Example:** PHASe:SPEED MEDIUM

---

## PHASe:SPEEd?

Returns the currently selected sweep speed.

**Related Commands:** PHASe:SPEEd

**Syntax:** PHASe:SPEEd?

**Example:** PHASe:SPEED?

**Response:** SPEED MEDIUM;

---

## PHASe:STEPs

Selects the sweep mode or the number of sweep steps. A step value of 0 selects the 1/3 octave frequency table if a frequency sweep is desired (SWPTtype is FREQ) or 2 dB steps if an amplitude sweep is desired (SWPTtype is AMPL). A step value of -1 selects the external sweep mode if SWPTtype is FREQ. All other values select the internal sweep mode with the indicated number of steps calculated using the FMIN and FMAX values for frequency sweeps and using the AMIN and AMAX values for amplitude sweeps. STEPs -1 (external sweep) is not permitted if SWPTtype is AMPL.

**Related Commands:** PHASe:EXTernal, PHASe:FMIN, PHASe:FMAX, PHASe:STEPs

**Syntax:** PHASe:STEPs { -1 | 0 | 3 | 5 | 10 | 15 | 30 | 75 | 150 }

**Factory Default:** 0

**Example:** PHASe:STEPs 30

---

## PHASe:STEPs?

Returns the selected sweep mode or the number of sweep steps selected for the internal sweep mode.

**Related Commands:** PHASe:STEPs

**Syntax:** PHASe:STEPs?

**Example:** PHASe:STEPs?

**Response:** STEPs 30;

---

## PHASe:SWPType

Specifies that either a frequency sweep or amplitude sweep is to be performed when the SWEEP START command is received. Amplitude sweeps and frequency sweeps proceed from high to low (from FMAX to FMIN and from AMIN to AMAX). The type of sweep is dependent on the currently selected generator (ANALOG, DIGITAL, or JITTER) and the currently selected measurement function. The currently displayed or last-selected generator will be used. SWPType AMPL is not permitted if STEPs is -1 (external sweep).

**Related Commands:** GENERator, DGENERator, and measurement function settings STEPs, FMAX, FMIN, AMAX, AMIN, EXTernal

**Syntax:** PHASe:SWPType { FREQ | AMPL }

**Factory Default:** FREQ

**Example:** PHASE:SWPTYPE AMPL

---

## PHASe:SWPType?

Returns the setting of the sweep type, indicating that either a frequency sweep or amplitude sweep is to be performed when the SWEEP START command is received.

**Related Commands:** GENERator, DGENERator, and measurement function settings STEPs, FMAX, FMIN, AMAX, AMIN, EXTernal

**Syntax:** PHASe:SWPType?

**Example:** PHASE:SWPTYPE?

**Response:** SWPTYPE AMPL;

---

## PHASe:UNIT

Selects the default degree measurement units for the PHASE function. This command is included only for the sake of consistency and is not needed to specify degree units.

**Related Commands:** PHASe:UNIT?

**Syntax:** PHASe:UNIT DEG

**Factory Default:** DEG

**Example:** PHASE:UNIT DEG

---

## PHASe:UNIT?

Returns the degree units setting for the PHASE function.

**Related Commands:** PHASe:UNIT

**Syntax:** PHASe:UNIT?

**Example:** PHASE:UNIT?

**Response:** UNIT DEG;

---

## RATio:

Compound command header for the Ratio measurement function.

---

### RATio:AMAX

For the Access instrument, this command sets the maximum amplitude level for an amplitude sweep of the analog generator when the SWPType command is set to AMPL. For the Dual Domain instrument this command sets the maximum amplitude level for an amplitude sweep of the analog generator, the digital generator, or the jitter generator when the SWPType command is set to AMPL.

The numeric argument and its unit should be within the valid amplitude range of the generator and its waveform type. Thus for the Access instrument, the maximum level for an amplitude sweep will be the argument value and units for the analog generator. For the Dual Domain instrument, the maximum level for an amplitude sweep will be the argument value and units for the generator last selected with the GENERator command or selected by the user with the front panel OUTPUT button.

If the AMAX argument value is less than the current setting of the AMIN command but within the range of the generator, then the AMIN command setting will be coerced to a lower value and no error will be generated.

Error 4 “CONFLICT WITH MAXIMUM AMPLITUDE” will be generated if the argument is outside of the range of the generator.

For the Dual Domain instrument, set the generator type and unit before sending the AMAX command. Subsequent changes to the generator type may cause the AMAX setting to be changed.

See Section 1 General Information – Sweeps for more information about interactions between amplitude sweep parameters and changes of the currently selected generator.

**Related Commands:** RATio:AMIN, RATio:AMAX?, SWPType

**Syntax:** RATio:AMAX <nrf> unit

**Factory Default:** 1.0 V

**Example:** RATIO:AMAX 1. V

---

### RATio:AMAX?

Returns the maximum amplitude level set by the AMAX command.

**Related Commands:** RATio:AMAX

**Syntax:** RATio:AMAX?

**Example:** RATIO:AMAX?

**Response:** AMAX 1. V;

---

## RATio:AMIN

For the Access instrument, this command sets the minimum amplitude level for an amplitude sweep of the analog generator when the SWPType command is set to AMPL. For the Dual Domain instrument this command sets the minimum amplitude level for an amplitude sweep of the analog generator, the digital generator, or the jitter generator when the SWPType command is set to AMPL.

The numeric argument and its unit should be within the valid amplitude range of the generator and its waveform type. Thus for the Access instrument, the minimum level for an amplitude sweep will be the argument value and units for the analog generator. For the Dual Domain instrument, the minimum level for an amplitude sweep will be the argument value and units for the generator last selected with the GENERator command or selected by the user with the front panel OUTPUT button.

If the AMIN argument value is greater than the current setting of the AMAX command but within the range of the generator, then the AMAX command setting will be coerced to a higher value and no error will be generated.

Error 5 “CONFLICT WITH MINIMUM AMPLITUDE” will be generated if the argument is outside of the range of the generator.

For the Dual Domain instrument, set the generator type and unit before sending the AMIN command with compatible units. Subsequent changes to the generator may cause the AMIN setting to be changed.

See Section 1 General Information – Sweeps for more information about interactions between amplitude sweep parameters and changes of the currently selected generator.

**Related Commands:** RATio:AMIN?, RATio:AMAX, SWPType

**Syntax:** RATio:AMIN <nrf> unit

**Factory Default:** 0.0 V

**Example:** RATIO:AMIN 0. V

---

## RATio:AMIN?

Returns the minimum amplitude level set by the AMIN command.

**Related Commands:** RATio:AMIN

**Syntax:** RATio:AMIN?

**Example:** RATIO:AMIN?

**Response:** AMIN 0. V;

---

## RATio:EXtErnal

Selects glide or step settling in external sweep mode.

**Related Commands:** RATio:STEPs, RATio:EXtErnal?

**Syntax:** RATio:EXtErnal { GLIDe | STEP }

**Factory Default:** GLIDE

**Example:** RATIO:EXTERNAL STEP

---

## RATio:EXTErnal?

Returns the current external sweep settling mode.

**Related Commands:** RATio:EXTErnal  
**Syntax:** RATio:EXTErnal?  
**Example:** RATIO:EXTERNAL?  
**Response:** EXTERNAL STEP;

---

## RATio:FMAX

Selects the upper frequency display range for the sweep and bargraph displays. The frequency sweep step values will be computed using this value.

**Related Commands:** RATio:FMIN, RATio:FMAX?, GAMPlitude, GFRequency, WAVeform  
**Syntax:** RATio:FMAX <nrf> [ HZ ]  
**Factory Default:** 20000 HZ  
**Example:** RATIO:FMAX 16K HZ

---

## RATio:FMAX?

Returns the current upper frequency range setting for the sweep and bargraph displays.

**Related Commands:** RATio:FMAX  
**Syntax:** RATio:FMAX?  
**Example:** RATIO:FMAX?  
**Response:** FMAX 16E+3 HZ;

---

## RATio:FMIN

Selects the lower frequency display range for the sweep and bargraph displays. The frequency sweep step values will be computed using this value.

**Related Commands:** RATio:FMAX, RATio:FMIN?, GAMPlitude, GFRequency, WAVeform  
**Syntax:** RATio:FMIN <nrf> [ HZ ]  
**Factory Default:** 20 HZ  
**Example:** RATIO:FMIN 200 HZ

---

## RATio:FMIN?

Returns the current lower frequency range setting for the sweep and bargraph displays.

**Related Commands:** RATio:FMIN  
**Syntax:** RATio:FMIN?  
**Example:** RATIO:FMIN?  
**Response:** FMIN 200 HZ;

---

## RATio:LUNit

Selects the Ratio function Level measurement units. OFF turns the level measurement display off.

**Related Commands:** RATio:LUNit?, REFDBR, REFDBM, REFWatt

**Syntax:** RATio:LUNit { V | DBV | DBU | DBM | DBR | DBG | W | OFF }

**Factory Default:** V

**Example:** RATIO:LUNIT DBM

---

## RATio:LUNit?

Returns the currently selected Ratio function Level measurement units.

**Related Commands:** RATio:LUNit

**Syntax:** RATio:LUNit?

**Example:** RATIO:LUNIT?

**Response:** LUNIT DBM;

---

## RATio:MMAx

Selects the upper magnitude display range for the sweep and bargraph displays in currently selected units. The selected units will be the displayed units only if the bargraph or sweep is being displayed when this command is received.

**Related Commands:** RATio:MMAx

**Syntax:** RATio:MMAx <nrf> [ X/Y | DB ]

**Factory Default:** 20 DB

**Example:** RATIO:MMAx 80 DB

---

## RATio:MMAx?

Returns the current upper magnitude range setting for the sweep and bargraph displays in currently selected units.

**Related Commands:** RATio:MMAx

**Syntax:** RATio:MMAx?

**Example:** RATIO:MMAx?

**Response:** MMAx 80 DB;

---

## RATio:MMIN

Selects the lower magnitude display range for the sweep and bargraph displays. The selected units will be the displayed units only if the bargraph or sweep is being displayed when this command is received.

**Related Commands:** RATio:MMAx, RATio:MMIN?

**Syntax:** RATio:MMIN <nrf> [ X/Y | DB ]

**Factory Default:** -60 DB

**Example:** RATIO:MMIN 0 DB

---

**RATio:MMIN?**

Returns the current upper magnitude range setting for the sweep and bargraph displays in currently selected units.

**Related Commands:** RATio:MMIN  
**Syntax:** RATio:MMIN?  
**Example:** RATIO:MMIN?  
**Response:** MMIN 0 DB;

---

**RATio:MODE**

Selects the sensitivity mode for two channel level ratio measurements, either Mode 1 or Mode 2. Mode 1 requires a signal level of at least 8 mV for the input channel used for the denominator when calculating the Ratio measurement. Mode 1 is backward compatible with earlier versions of the Portable One Plus and ATS-1 analyzers. Mode 2 requires a signal level of at least 8 mV for the input channel used for the numerator when calculating the Ratio measurement.

**Related Commands:** RATio:MODE?  
**Syntax:** RATio:MODE <nr1> [ 1 | 2 ]  
**Factory Default:** MODE 1  
**Example:** RATIO:MODE 2

---

**RATio:MODE?**

Returns the setting of the sensitivity mode for two channel level ratio measurements, either Mode 1 or Mode 2.

**Related Commands:** RATio:MODE  
**Syntax:** RATio:MODE?  
**Example:** RATIO:MODE?  
**Response:** RATIO:MODE 2

---

**RATio:SET?**

Returns the query responses for all the queries under the :RATIO: compound command header. The response is preceded by :DISP GPIB and followed by :DISPLAY *current\_display\_panel*. Equivalent to sending the following query string:

```
RATIO:AMAX?;AMIN?;EXTERNAL?;FMAX?;FMIN?;LUNIT?;MMA
X?;MMIN?;MODE?;SPEED?;STEPS?;SWPTYPE?;UNIT?;
```

**Related Commands:** All RATio: queries  
**Syntax:** RATio:SET?  
**Example:** RATIO:SET?  
**Response:** :DISP GPIB;:RATIO:AMAX 1. V;AMIN 0. V;EXTERNAL
GLIDE;FMAX 20.E+3 HZ;FMIN 20. HZ;LUNIT V;MMA
X 20. DB;MMIN -60. DB;MODE 1;SPEED FAST;STEPS
0;SWPTYPE FREQ;UNIT DB;:DISPLAY PANEL;

---

## RATio:SPEed

Selects the sweep speed.

**Related Commands:** RATio:SPEed?  
**Syntax:** RATio:SPEed { FAST | MEDium | SLOW }  
**Factory Default:** FAST  
**Example:** RATIO:SPEED MEDIUM

---

## RATio:SPEed?

Returns the currently selected sweep speed.

**Related Commands:** RATio:SPEed  
**Syntax:** RATio:SPEed?  
**Example:** RATIO:SPEED?  
**Response:** SPEED MEDIUM;

---

## RATio:STEPS

Selects the sweep mode or the number of sweep steps. A step value of 0 selects the 1/3 octave frequency table if a frequency sweep is desired (SWPType is FREQ) or 2 dB steps if an amplitude sweep is desired (SWPType is AMPL). A step value of -1 selects the external sweep mode if SWPType is FREQ. All other values select the internal sweep mode with the indicated number of steps calculated using the FMIN and FMAX values for frequency sweeps and using the AMIN and AMAX values for amplitude sweeps. STEPs -1 (external sweep) is not permitted if SWPType is AMPL.

**Related Commands:** RATio:EXTernal, RATio:FMIN,R ATio:FMAX, RATio:STEPS  
**Syntax:** RATio:STEPS { -1 | 0 | 3 | 5 | 10 | 15 | 30 | 75 | 150 }  
**Factory Default:** 0  
**Example:** RATIO:STEPS 75

---

## RATio:STEPS?

Returns the selected sweep mode or the number of sweep steps selected for the internal sweep mode.

**Related Commands:** RATio:STEPS  
**Syntax:** RATio:STEPS?  
**Example:** RATIO:STEPS?  
**Response:** STEPS 75;

---

**RATio:SWPType**

Specifies that either a frequency sweep or amplitude sweep is to be performed when the SWEEP START command is received. Amplitude sweeps and frequency sweeps proceed from high to low (from FMAX to FMIN and from AMIN to AMAX). The type of sweep is dependent on the currently selected generator (ANALOG, DIGITAL, or JITTER) and the currently selected measurement function. The currently displayed or last-selected generator will be used. SWPType AMPL is not permitted if STEPs is -1 (external sweep).

**Related Commands:** GENerator, DGENerator, and measurement function settings STEPs, FMAX, FMIN, AMAX, AMIN, EXTernal

**Syntax:** RATio:SWPType { FREQ | AMPL }

**Factory Default:** FREQ

**Example:** RATIO:SWPTYPE AMPL

---

**RATio:SWPType?**

Returns the setting of the sweep type, indicating that either a frequency sweep or amplitude sweep is to be performed when the SWEEP START command is received.

**Related Commands:** GENerator, DGENerator, and measurement function settings STEPs, FMAX, FMIN, AMAX, AMIN, EXTernal

**Syntax:** RATio:SWPType?

**Example:** RATIO:SWPTYPE?

**Response:** SWPTYPE AMPL;

---

**RATio:UNIT**

Selects either X/Y or dB units for the Ratio measurement function.

**Related Commands:** RATio:UNIT?

**Syntax:** RATio:UNIT { X/Y | DB }

**Factory Default:** DB

**Example:** RATIO:UNIT X/Y

---

**RATio:UNIT?**

Returns the currently selected Ratio measurement function units.

**Related Commands:** RATio:UNIT

**Syntax:** RATio:UNIT?

**Example:** RATIO:UNIT?

**Response:** UNIT X/Y;

---

## SINad:

Compound command header for the SINAD measurement parameters.

---

### SINad:HPASS

Enables and disables the SINAD high pass filter. If ON the frequency is 400 Hz. If OFF the frequency is 10 Hz or 22 Hz if BPASS is set at either R22K or Q22K.

**Related Commands:** SINad:LPASs, SINad:HPASs?

**Syntax:** SINad:HPASs { ON | OFF }

**Factory Default:** OFF

**Example:** SINAD:HPASS ON

---

### SINad:HPASs?

Returns the current state of the SINAD high pass filter, ON or OFF.

**Related Commands:** SINad:HPASs

**Syntax:** SINad:HPASs?

**Example:** SINAD:HPASS?

**Response:** HPASS ON;

---

### SINad:LPASS

Selects the SINAD band pass filter .

**Related Commands:** SINad:HPASs, SINad:LPASs?

**Syntax:** SINad:LPASs { R22k | Q22k | R30k | R80k | R300k }

**Factory Default:** R30K

**Example:** SINAD:LPASS R22K

---

### SINad:LPASs?

Returns the current SINAD band pass filter.

**Related Commands:** SINad:HPASs, SINad:LPASs?

**Syntax:** SINad:LPASs { R22k | Q22k | R30k | R80k | R300k }

**Factory Default:** R30K

**Example:** SINAD:LPASS?

**Response:** LPASS R22K;

---

### SINad:LUNit

Selects the measurement units for the Level measurement in the SINAD function. OFF turns the level measurement display off.

**Related Commands:** SINad:LUNit?, REFDBR, REFBDM, REFWatt

**Syntax:** SINad:LUNit { V | DBV | DBU | DBM | DBR | DBG | W | OFF }

**Factory Default:** V

**Example:** SINAD:LUNIT DBV

---

## SINad:LUNit?

Returns the current measurement units for the level measurement in the SINAD function.

**Related Commands:** SINad:LUNit  
**Syntax:** SINad:LUNit?  
**Example:** SINAD:LUNIT?  
**Response:** LUNIT DBV;

---

## SINad:MMAx

Selects the upper magnitude display range for the bargraph display. DB units are optional.

**Related Commands:** SINad:MMIN, SINad:MMAx?  
**Syntax:** SINad:MMAx <nrf> [ DB ]  
**Factory Default:** 40 DB  
**Example:** SINAD:MMAx 20 DB

---

## SINad:MMAx?

Returns the current upper magnitude range setting for the bargraph display in currently selected units.

**Related Commands:** SINad:MMAx  
**Syntax:** SINad:MMAx?  
**Example:** SINAD:MMAx?  
**Response:** MMAx 20. DB;

---

## SINad:MMIN

Selects the lower magnitude display range for the bargraph display. DB units are optional.

**Related Commands:** SINad:MMAx, SINad:MMIN?  
**Syntax:** SINad:MMIN <nrf> [ DB ]  
**Factory Default:** -140 DB  
**Example:** SINAD:MMIN -80 DB

---

## SINad:MMIN?

Returns the current upper magnitude range setting for the bargraph display in currently selected units.

**Related Commands:** SINad:MMIN  
**Syntax:** SINad:MMIN?  
**Example:** SINAD:MMIN?  
**Response:** MMIN -80. DB;

---

## SINad:NOTChfreq

Selects the center frequency for the tunable notch filter when TUNE is set to FIXTUNE. The HZ unit is optional. Does not set the notch frequency in other notch tuning modes and issues a Device Dependent Error if this is attempted.

**Related Commands:** SINad:TUNe  
**Syntax:** SINad:NOTChfreq <nrf> [ HZ ]  
**Factory Default:** 400  
**Example:** SINAD:NOTCHFREQ 1K HZ

---

## SINad:NOTChfreq?

Returns the selected center frequency for the tunable notch filter when TUNE is set to FIXTUNE.

**Related Commands:** SINad:TUNe  
**Syntax:** SINad:NOTChfreq?  
**Example:** SINAD:NOTCHFREQ?  
**Response:** NOTCHFREQ 1.E+3 HZ;

---

## SINad:SET?

Returns the query responses for all the queries under the :SINAD: compound command header. The response is preceded by :DISP GPIB and followed by :DISPLAY *current\_display\_panel*.

Equivalent to sending the following query string:

```
SINAD:HPASS?;LPASS?;LUNIT?;MMAX?;MMIN?;NOTCHFREQ
?;PRESET?; TUNE?;UNIT?;
```

**Related Commands:** All SINad: queries  
**Syntax:** SINad:SET?  
**Example:** SINAD:SET?  
**Response:** :DISP GPIB;:SINAD:HPASS OFF;LPASS R30K;LUNIT V;MMAX 40. DB;MMIN -140. DB;NOTCHFREQ 400. HZ;PRESET F400;TUNE OFF;UNIT DB;:DISPLAY PANEL;

---

## SINad:PRESet

Selects the PRESET setting to set both the generator frequency and the SINAD notch filter frequency to either 400 Hz (F400) or 1000 Hz (F1000). Enabled only when the SINAD:TUNE command is set to OFF.

**Related Commands:** SINad:NOTChfreq, SINad:TUNe, GFREquency  
**Syntax:** SINad:PRESet { F400 | F1000 }  
**Factory Default:** F400  
**Example:** SINAD:PRESET F1000

---

**SINad:PRESet?**

Returns the PRESET setting for the SINAD function.

**Related Commands:** SINad:PRESet

**Syntax:** SINad:PRESet?

**Example:** SINAD:PRESET?

**Response:** PRESET F1000;

---

**SINad:TUNE**

Selects the notch filter tuning mode for the SINAD function. Defaults to OFF. OFF enables the PRESET setting to set the generator frequency and the notch filter frequency to either 400 Hz or 1000 Hz. GENTRACK causes the notch frequency to be set to the frequency of the generator and tracks to that frequency when a change is made to the generator frequency. FIXTUNE causes the NOTCHFREQ command to change the notch frequency independently from the generator frequency.

**Related Commands:** SINAD:TUNE?, SINad:NOTChfreq, SINad:PRESet, GFRequency

**Syntax:** SINad:TUNe { GENTrack | FIXTune | OFF }

**Factory Default:** OFF

**Example:** SINAD:TUNE FIXTUNE

---

**SINad:TUNE?**

Returns the notch filter tuning mode for the SINAD function.

**Related Commands:** SINad:TUNe

**Syntax:** SINad:TUNE?

**Example:** SINAD:TUNE?

**Response:** TUNE FIXTUNE;

---

**SINad:UNIT**

Selects the default dB measurement units for the SINAD meter.

**Related Commands:** SINad:UNIT?

**Syntax:** SINad:UNIT DB

**Factory Default:** DB

**Example:** SINAD:UNIT DB

---

**SINad:UNIT?**

Returns the dB units for the SINAD meter.

**Related Commands:** SINad:UNIT

**Syntax:** SINad:UNIT?

**Example:** SINAD:UNIT?

**Response:** UNIT DB;

---

## THD:

Compound command header for the THD measurement function parameters.

---

### THD:AMAX

For the Access instrument, this command sets the maximum amplitude level for an amplitude sweep of the analog generator when the SWPType command is set to AMPL. For the Dual Domain instrument this command sets the maximum amplitude level for an amplitude sweep of the analog generator, the digital generator, or the jitter generator when the SWPType command is set to AMPL.

The numeric argument and its unit should be within the valid amplitude range of the generator and its waveform type. Thus for the Access instrument, the maximum level for an amplitude sweep will be the argument value and units for the analog generator. For the Dual Domain instrument, the maximum level for an amplitude sweep will be the argument value and units for the generator last selected with the GENERATOR command or selected by the user with the front panel OUTPUT button.

If the AMAX argument value is less than the current setting of the AMIN command but within the range of the generator, then the AMIN command setting will be coerced to a lower value and no error will be generated.

Error 4 “CONFLICT WITH MAXIMUM AMPLITUDE” will be generated if the argument is outside of the range of the generator.

For the Dual Domain instrument, set the generator type and unit before sending the AMAX command. Subsequent changes to the generator type may cause the AMAX setting to be changed.

See Section 1 General Information – Sweeps for more information about interactions between amplitude sweep parameters and changes of the currently selected generator.

**Related Commands:** THD:AMIN, THD:AMAX?, SWPType

**Syntax:** THD:AMAX <nrf> unit

**Factory Default:** 1.0 V

**Example:** THD:AMAX 1. V

---

### THD:AMAX?

Returns the maximum amplitude level set by the AMAX command.

**Related Commands:** THD:AMAX

**Syntax:** THD:AMAX?

**Example:** THD:AMAX?

**Response:** AMAX 1. V;

---

## THD:AMIN

For the Access instrument, this command sets the minimum amplitude level for an amplitude sweep of the analog generator when the SWPType command is set to AMPL. For the Dual Domain instrument this command sets the minimum amplitude level for an amplitude sweep of the analog generator, the digital generator, or the jitter generator when the SWPType command is set to AMPL.

The numeric argument and its unit should be within the valid amplitude range of the generator and its waveform type. Thus for the Access instrument, the minimum level for an amplitude sweep will be the argument value and units for the analog generator. For the Dual Domain instrument, the minimum level for an amplitude sweep will be the argument value and units for the generator last selected with the GENerator command or selected by the user with the front panel OUTPUT button.

If the AMIN argument value is greater than the current setting of the AMAX command but within the range of the generator, then the AMAX command setting will be coerced to a higher value and no error will be generated.

Error 5 “CONFLICT WITH MINIMUM AMPLITUDE” will be generated if the argument is outside of the range of the generator.

For the Dual Domain instrument, set the generator type and unit before sending the AMIN command with compatible units. Subsequent changes to the generator may cause the AMIN setting to be changed.

See Section 1 General Information – Sweeps for more information about interactions between amplitude sweep parameters and changes of the currently selected generator.

**Related Commands:** THD:AMIN?, THD:AMAX, SWPType

**Syntax:** THD:AMIN <nrf> unit

**Factory Default:** 0.0 V

**Example:** THD:AMIN 0. V

---

## THD:AMIN?

Returns the minimum amplitude level set by the AMIN command.

**Related Commands:** THD:AMIN

**Syntax:** THD:AMIN?

**Example:** THD:AMIN?

**Response:** AMIN 0. V;

---

## THD:EXtErnal

Selects glide or step in external sweep mode.

**Related Commands:** THD:STEPS, THD:EXtErnal?

**Syntax:** THD:EXtErnal { GLIDe | STEP }

**Factory Default:** GLIDE

**Example:** THD:EXTERNAL STEP

---

## THD:EXternal?

Returns the current external sweep settling mode.

**Related Commands:** THD:EXternal  
**Syntax:** THD:EXternal?  
**Example:** THD:EXTERNAL?  
**Response:** EXTERNAL STEP;

---

## THD:FILTER

Selects the filter for the THD function, identical to the front-panel selection. The AVERage filter is the UNWTD filter with a math averaging function enabled.

**Related Commands:** THD:WTD, THD:HPASs, THD:LPASs, THD:FILTer?  
**Syntax:** THD:FILTer { WTD | UNWTD | AVERage }  
**Factory Default:** UNWTD  
**Example:** THD:FILTER AVERAGE

---

## THD:FILTer?

Returns the current filter for the THD function.

**Related Commands:** THD:FILTer  
**Syntax:** THD:FILTer?  
**Example:** THD:FILTER?  
**Response:** FILTER AVERAGE;

---

## THD:FMAX

Selects the upper frequency display range for the sweep display. The frequency sweep step values will be computed using this value. The HZ unit is optional.

**Related Commands:** THD:FMIN, THD:FMAX?, GAMplitude, GFREquency, WAVeform  
**Syntax:** THD:FMAX <nrf> [ HZ ]  
**Factory Default:** 20 KHZ  
**Example:** THD:FMAX 22 KHZ

---

## THD:FMAX?

Returns the current upper frequency range setting for the sweep display.

**Related Commands:** THD:FMAX  
**Syntax:** THD:FMAX?  
**Example:** THD:FMAX?  
**Response:** FMAX 22.E+3 HZ;

---

## THD:FMIN

Selects the lower frequency display range for the sweep display. The frequency sweep step values will be computed using this value. The HZ unit is optional.

**Related Commands:** THD:FMIN  
**Syntax:** THD:FMIN <nrf> [ HZ ]  
**Factory Default:** 20 HZ  
**Example:** THD:FMIN 200

---

## THD:FMIN?

Returns the current lower frequency range setting for the sweep display.

**Related Commands:** THD:FMIN  
**Syntax:** THD:FMIN?  
**Example:** THD:FMIN?  
**Response:** FMIN 200. HZ;

---

## THD:HPASS

Enables and disables the high pass filter. If ON, the frequency is 400 Hz. If OFF, the frequency is 10 Hz or 22 Hz if UNWTD filter is selected with BPASS set at either R22K or Q22K.

**Related Commands:** THD:LPASs, THD:FILTer, THD:HPASs?  
**Syntax:** THD:HPASs { ON | OFF }  
**Factory Default:** OFF  
**Example:** THD:HPASS ON

---

## THD:HPASS?

Returns the current state of the high pass filter, ON or OFF.

**Related Commands:** THD:HPASs  
**Syntax:** THD:HPASs?  
**Example:** THD:HPASS?  
**Response:** HPASS ON;

---

## THD:LPASS

Selects the band pass filter when the UNWTD filter is selected.

**Related Commands:** THD:HPASs, THD:FILTer, THD:LPASs?  
**Syntax:** THD:LPASs { R22k | Q22k | R30k | R80k | R300k }  
**Factory Default:** R80K  
**Example:** THD:LPASS R300K

---

**THD:LPASSs?**

Returns the current band pass filter for the UNWTD filter.

**Related Commands:** THD:LPASSs  
**Syntax:** THD:LPASSs?  
**Example:** THD:LPASS?  
**Response:** LPASS R300K;

---

**THD:LUNit**

Selects the measurement units for the Level measurement in the THD function. OFF turns off the level measurement display.

**Related Commands:** THD:LUNit?, REFDBR, REFDBM, REFWatt  
**Syntax:** THD:LUNit { V | DBV | DBU | DBM | DBR | DBG | W | OFF }  
**Factory Default:** V  
**Example:** THD:LUNIT OFF

---

**THD:LUNit?**

Returns the current measurement units for the Level measurement in the THD function.

**Related Commands:** THD:LUNit  
**Syntax:** THD:LUNit?  
**Example:** THD:LUNIT?  
**Response:** LUNIT OFF;

---

**THD:MMAx**

Selects the upper magnitude display range for the sweep and bargraph displays in currently selected units. The selected units will be the displayed units only if the bargraph or sweep is being displayed when this command is received.

**Related Commands:** THD:MMIN, THD:MMAx?  
**Syntax:** THD:MMAx <nrf> [ PCT | DB | V | DBV | DBU | DBM | DBR ]  
**Factory Default:** 1 PCT  
**Example:** THD:MMAx 5 PCT

---

**THD:MMAx?**

Returns the current upper magnitude range setting for the sweep and bargraph displays in currently selected units.

**Related Commands:** THD:MMAx  
**Syntax:** THD:MMAx?  
**Example:** THD:MMAx?  
**Response:** MMAx 5. PCT;

---

**THD:MMIN**

Selects the lower magnitude display range for the sweep and bargraph displays. The selected units will be the displayed units only if the bargraph or sweep is being displayed when this command is received.

**Related Commands:** THD:MMAX, THD:MMIN?

**Syntax:** THD:MMIN <nrf> [ PCT | DB | V | DBV | DBU | DBM | DBR ]

**Factory Default:** 0.0001 PCT

**Example:** THD:MMIN 0.02 PCT

---

**THD:MMIN?**

Returns the current upper magnitude range setting for the sweep and bargraph displays in currently selected units.

**Related Commands:** THD:MMIN

**Syntax:** THD:MMIN?

**Example:** THD:MMIN?

**Response:** MMIN 0.02 PCT;

---

**THD:NOTChfreq**

Selects the center frequency for the tunable notch filter when TUNE is set to FIXTUNE. The HZ unit is optional.

**Related Commands:** THD:TUNE, THD:NOTChfreq?

**Syntax:** THD:NOTChfreq <nrf> [ HZ ]

**Factory Default:** 1000

**Example:** THD:NOTCHFREQ 5000

---

**THD:NOTChfreq?**

Returns the selected center frequency for the tunable notch filter when TUNE is set to FIXTUNE.

**Related Commands:** THD:NOTChfreq

**Syntax:** THD:NOTChfreq?

**Example:** THD:NOTCHFREQ?

**Response:** NOTCHFREQ 5.0E+3 HZ;

---

**THD:SET?**

Returns the query responses for all the queries under the :THD: compound command header. The response is preceded by :DISP GPIB and followed by :DISPLAY *current\_display\_panel*. Equivalent to sending the following query string:

```
THD:AMAX?;AMIN?;EXTERNAL?;FILTER?;FMAX?;FMIN?;HPASS?;LPASS?;LUNIT?;MMAX?;MMIN?;NOTCHFREQ?;SPEED?;STEPS?;SWPTYPE?;TUNE?;UNIT?;WTD?;
```

**Related Commands:** All THD: queries

**Syntax:** THD:SET?

**Example:** THD:SET?

**Response:** :DISP GPIB;:THD:AMAX 1. V;AMIN 0. V;EXTERNAL GLIDE;FILTER UNWTD;FMAX 20.E+3 HZ;FMIN 20. HZ;HPASS OFF;LPASS R80K;LUNIT V;MMAX 1. PCT;MMIN 0.0001 PCT;NOTCHFREQ 1.E+3 HZ;SPEED FAST;STEPS 0;SWPTYPE FREQ;TUNE AUTO;UNIT PCT;WTD RMSCCIR;:DISPLAY PANEL;

---

**THD:SPEEd**

Selects the sweep speed.

**Related Commands:** THD:SPEEd?

**Syntax:** THD:SPEEd { FAST | MEDium | SLOW }

**Factory Default:** FAST

**Example:** THD:MEDIUM

---

**THD:SPEEd?**

Returns the currently selected sweep speed.

**Related Commands:** THD:SPEEd

**Syntax:** THD:SPEEd?

**Example:** THD:SPEED?

**Response:** SPEED MEDIUM;

---

**THD:STEPS**

Selects the sweep mode or the number of sweep steps. A step value of 0 selects the 1/3 octave frequency table if a frequency sweep is desired (SWPTtype is FREQ) or 2 dB steps if an amplitude sweep is desired (SWPTtype is AMPL). A step value of -1 selects the external sweep mode, all other values select the internal sweep mode with the indicated number of steps calculated using the FMIN and FMAX values for frequency sweeps and using the AMIN and AMAX values for amplitude sweeps. STEPs -1 (external sweep) is not permitted if SWPTtype is AMPL.

**Related Commands:** THD:EXTernal, THD:FMIN, THD:FMAX, THD:STEPS?

**Syntax:** THD:STEPS { -1 | 0 | 3 | 5 | 10 | 15 | 30 | 75 | 150 }

**Factory Default:** 0

**Example:** THD:STEPS -1

---

**THD:STEPS?**

Returns the selected sweep mode or the number of sweep steps selected for the internal sweep mode.

**Related Commands:** THD:STEPS  
**Syntax:** THD:STEPS?  
**Example:** THD:STEPS?  
**Response:** STEPS -1;

---

**THD:SWPTtype**

Specifies that either a frequency sweep or amplitude sweep is to be performed when the SWEEP START command is received. Amplitude sweeps and frequency sweeps proceed from high to low (from FMAX to FMIN and from AMIN to AMAX). The type of sweep is dependent on the currently selected generator (ANALOG, DIGITAL, or JITTER) and the currently selected measurement function. The currently displayed or last-selected generator will be used. SWPTtype AMPL is not permitted if STEPS is -1 (external sweep).

**Related Commands:** GENERator, DGENERator, and measurement function settings STEPS, FMAX, FMIN, AMAX, AMIN, EXTernal  
**Syntax:** THD:SWPTtype { FREQ | AMPL }  
**Factory Default:** FREQ  
**Example:** THD:SWPTYPE AMPL

---

**THD:SWPTtype?**

Returns the setting of the sweep type, indicating that either a frequency sweep or amplitude sweep is to be performed when the SWEEP START command is received.

**Related Commands:** GENERator, DGENERator, and measurement function settings STEPS, FMAX, FMIN, AMAX, AMIN, EXTernal  
**Syntax:** THD:SWPTtype?  
**Example:** THD:SWPTYPE?  
**Response:** SWPTYPE AMPL;

---

**THD:TUNe**

Selects the notch filter tuning mode for the THD function.

**Related Commands:** THD:NOTChfreq, THD:TUNe?  
**Syntax:** THD:TUNe { AUTO | GENTrack | FIXTune }  
**Factory Default:** AUTO  
**Example:** THD:TUNE FIXTUNE

---

**THD:TUNe?**

Returns the notch filter tuning mode for the THD function.

**Related Commands:** THD:TUNe  
**Syntax:** THD:TUNe?  
**Example:** THD:TUNE?  
**Response:** TUNE FIXTUNE;

---

## THD:UNIT

Selects the measurement units for the THD function.

**Related Commands:** THD:UNIT?, REFDBR, REFDBM

**Syntax:** THD:UNIT { PCT | DB | V | DBV | DBU | DBM | DBR }

**Factory Default:** PCT

**Example:** THD:UNIT DB

---

## THD:UNIT?

Returns the current units for the THD function.

**Related Commands:** THD:UNIT

**Syntax:** THD:UNIT?

**Example:** THD:UNIT?

**Response:** UNIT DB;

---

## THD:WTD

Selects the weighting filter for the THD+N function when the WTD filter is selected. The choices are the same ones available from the front panel.

Note that the RMSCCIR filter choice is displayed on the front panel as CCIR-1K.

**Related Commands:** THD:FILT<sub>er</sub>, THD:WTD?

**Syntax;** THD:WTD { AUX1 | AUX2 | IECa | RMSCcir | CCIR2K | QPKCcir | ARMCcir }

**Factory Default:** RMSCCIR

**Example:** THD:WTD AUX2

---

## THD:WTD?

Returns the currently selected weighting filter for the THD+N function.

**Related Commands:** THD:WTD

**Syntax:** THD:WTD?

**Example:** THD:WTD?

**Response:** WTD AUX2;

---

## WF:

Compound command header for the Wow and Flutter measurement function parameters.

---

### WF:DETECTOR

Selects the W+F detector.

**Related Commands:** WF:DETECTOR?  
**Syntax:** WF:DETECTOR { IEC | NAB | JIS }  
**Factory Default:** IEC  
**Example:** WF:DETECTOR NAB

---

### WF:DETECTOR?

Returns the currently selected W+F detector.

**Related Commands:** WF:DETECTOR  
**Syntax:** WF:DETECTOR?  
**Example:** WF:DETECTOR?  
**Response:** DETECTOR NAB;

---

### WF:FILTER

Selects the W+F weighted or unweighted filters.

**Related Commands:** WF:FILTER?  
**Syntax:** WF:FILTER { WTD | UNWTD }  
**Factory Default:** WTD  
**Example:** WF:FILTER UNWTD

---

### WF:FILTER?

Returns the currently selected W+F filter.

**Related Commands:** WF:FILTER  
**Syntax:** WF:FILTER?  
**Example:** WF:FILTER?  
**Response:** FILTER UNWTD;

---

### WF:LUNit

Selects the measurement units for the Level measurement in the W+F function.

**Related Commands:** WF:LUNit, REFDBM, REFDBR, REFWATT  
**Syntax:** WF:LUNit { V | DBV | DBU | DBM | DBR | DBG | W | OFF }  
**Factory Default:** V  
**Example:** WF:LUNIT DBV

---

**WF:LUNit?**

Returns the selected units for the level measurement in the W+F function.

**Related Commands:** WF:LUNit

**Syntax:** WF:LUNit?

**Example:** WF:LUNIT?

**Response:** LUNIT DBV;

---

**WF:MMAx**

Selects the upper magnitude display range for the bargraph display. The PCT unit is optional.

**Related Commands:** WF:MMAx?, WF:MMIN

**Syntax:** WF:MMAx <nrf> [ PCT ]

**Factory Default:** 1 PCT

**Example:** WF:MMAx 2.5 PCT

---

**WF:MMAx?**

Returns the current upper magnitude range setting for the bargraph display in currently selected units.

**Related Commands:** WF:MMAx

**Syntax:** WF:MMAx?

**Example:** WF:MMAx?

**Response:** MMAx 2.5 PCT;

---

**WF:MMIN**

Selects the lower magnitude display range for the bargraph display. The PCT unit is optional.

**Related Commands:** WF:MMAx, WF:MMIN?

**Syntax:** WF:MMIN <nrf> [ PCT ]

**Factory Default:** 0 PCT

**Example:** WF:MMIN 1.5 PCT

---

**WF:MMIN?**

Returns the current upper magnitude range setting for the bargraph display in currently selected units.

**Related Commands:** WF:MMIN

**Syntax:** WF:MMIN?

**Example:** :WF:MMIN?

**Response:** MMIN 1.5 PCT;

---

**WF:RESPonse**

Selects the measurement response mode for W+F measurements. PEAK selects peak measurements updated three times per second. SIG2 selects a running calculation of the 2-sigma value exceeded no more than 5% of the time (the second-highest reading of a running 20-reading group).

**Related Commands:** WF:RESPonse?

**Syntax:** WF:RESPonse { PEAK | SIG2 }

**Factory Default:** PEAK

**Example:** :WF:RESPONSE SIG2

---

**WF:RESPonse?**

Returns the currently selected W+F response mode, PEAK or SIG2.

**Related Commands:** WF:RESPonse

**Syntax:** WF:RESPonse?

**Example:** WF:RESPONSE?

**Response:** RESPONSE SIG2;

---

**WF:SET?**

Returns the query responses for all the queries under the :WF: compound command header. The response is preceded by :DISP GPIB and followed by :DISPLAY *current\_display\_panel*. Equivalent to sending the following query string:

```
WF:DETECT?;FILTER?;LUNIT?;MMAX?;MMIN?;RESPONSE?;UNIT?;WFUNIT?;
```

**Related Commands:** All WF: queries

**Syntax:** WF:SET?

**Example:** WF:SET?

**Response:** :DISP GPIB;:WF:DETECT IEC;FILTER WTD;LUNIT V;MMAX 1. PCT;MMIN 0. PCT;RESPONSE PEAK;UNIT PCT;WFUNIT HZ;:DISPLAY PANEL;

---

**WF:UNIT**

Selects the default percent measurement units for the W+F meter.

**Related Commands:** WF:UNIT?

**Syntax:** WF:UNIT PCT

**Factory Default:** PCT

**Example:** WF:UNIT PCT

---

**WF:UNIT?**

Returns the default percent units for the W+F meter.

**Related Commands:** WF:UNIT

**Syntax:** WF:UNIT?

**Example:** WF:UNIT?

**Response:** UNIT PCT;

---

**WF:WFUNit**

Selects the W+F function frequency meter units and reference frequency for frequency deviation measurements. HZ selects standard frequency measurements. DPCT3000 selects delta percent frequency with 3000 Hz frequency reference. DPCT3150 selects delta percent frequency with 3150 Hz frequency reference. OFF turns off the frequency measurement display.

**Related Commands:** WF:WFUNIT?

**Syntax:** WF:WFUNit { HZ | DPCT3000 | DPCT3150 | OFF }

**Factory Default:** HZ

**Example:** WF:WFUNIT DPCT3000

---

**WF:WFUNit?**

Returns the current selected frequency units for the W+F frequency meter.

**Related Commands:** WF:WFUNIT

**Syntax:** WF:WFUNIT?

**Example:** WF:WFUNIT?

**Response:** WFUNIT DPCT3000;

---

## XTALK:

Compound command header for the XTALK measurement parameters.

---

### XTALK:AMAX

For the Access instrument, this command sets the maximum amplitude level for an amplitude sweep of the analog generator when the SWPType command is set to AMPL. For the Dual Domain instrument this command sets the maximum amplitude level for an amplitude sweep of the analog generator, the digital generator, or the jitter generator when the SWPType command is set to AMPL.

The numeric argument and its unit should be within the valid amplitude range of the generator and its waveform type. Thus for the Access instrument, the maximum level for an amplitude sweep will be the argument value and units for the analog generator. For the Dual Domain instrument, the maximum level for an amplitude sweep will be the argument value and units for the generator last selected with the GENERATOR command or selected by the user with the front panel OUTPUT button.

If the AMAX argument value is less than the current setting of the AMIN command but within the range of the generator, then the AMIN command setting will be coerced to a lower value and no error will be generated.

Error 4 “CONFLICT WITH MAXIMUM AMPLITUDE” will be generated if the argument is outside of the range of the generator.

For the Dual Domain instrument, set the generator type and unit before sending the AMAX command. Subsequent changes to the generator type may cause the AMAX setting to be changed.

See Section 1 General Information – Sweeps for more information about interactions between amplitude sweep parameters and changes of the currently selected generator.

**Related Commands:** XTALK:AMIN, XTALK:AMAX?, SWPType

**Syntax:** XTALK:AMAX <nrf> unit

**Factory Default:** 1.0 V

**Example:** XTALK:AMAX 1. V

---

### XTALK:AMAX?

Returns the maximum amplitude level set by the AMAX command.

**Related Commands:** XTALK:AMAX

**Syntax:** XTALK:AMAX?

**Example:** XTALK:AMAX?

**Response:** AMAX 1. V;

---

### XTALK:AMIN

For the Access instrument, this command sets the minimum amplitude level for an amplitude sweep of the analog generator when the SWPType command is set to AMPL. For the Dual Domain instrument this command sets the minimum amplitude level for an

amplitude sweep of the analog generator, the digital generator, or the jitter generator when the SWPType command is set to AMPL.

The numeric argument and its unit should be within the valid amplitude range of the generator and its waveform type. Thus for the Access instrument, the minimum level for an amplitude sweep will be the argument value and units for the analog generator. For the Dual Domain instrument, the minimum level for an amplitude sweep will be the argument value and units for the generator last selected with the GENerator command or selected by the user with the front panel OUTPUT button.

If the AMIN argument value is greater than the current setting of the AMAX command but within the range of the generator, then the AMAX command setting will be coerced to a higher value and no error will be generated.

Error 5 “CONFLICT WITH MINIMUM AMPLITUDE” will be generated if the argument is outside of the range of the generator.

For the Dual Domain instrument, set the generator type and unit before sending the AMIN command with compatible units. Subsequent changes to the generator may cause the AMIN setting to be changed.

See Section 1 General Information – Sweeps for more information about interactions between amplitude sweep parameters and changes of the currently selected generator.

**Related Commands:** XTALK:AMIN?, XTALK:AMAX, SWPType

**Syntax:** XTALK:AMIN <nrf> unit

**Factory Default:** 0.0

**Example:** XTALK:AMIN 0. V

## XTALK:AMIN?

Returns the minimum amplitude level set by the AMIN command.

**Related Commands:** XTALK:AMIN

**Syntax:** XTALK:AMIN?

**Example:** XTALK:AMIN?

**Response:** AMIN 0. V;

## XTALK:EXTernal

Selects glide or step settling in external sweep mode.

**Related Commands:** XTALK:STEPS, XTALK:EXTernal?

**Syntax:** XTALK:EXTernal { GLIDe | STEP }

**Factory Default:** GLIDE

**Example:** XTALK:EXTERNAL STEP

## XTALK:EXTernal?

Returns the current external sweep settling mode.

**Related Commands:** XTALK:EXTernal

**Syntax:** XTALK:EXTernal?

**Example:** XTALK:EXTERNAL?

**Response:** EXTERNAL STEP;

---

**XTALK:FMAX**

Selects the upper frequency display range for the sweep and bargraph displays. The frequency sweep step values will be computed using this value. The HZ unit is optional.

**Related Commands:** XTALK:FMIN, XTALK:FMAX?, GAMplitude, GFREquency, WAVeform

**Syntax:** XTALK:FMAX <nrf> [ HZ ]

**Factory Default:** 20 KHZ

**Example:** XTALK:FMAX 16.0E+3 HZ

---

**XTALK:FMAX?**

Returns the current upper frequency range setting for the sweep and bargraph displays.

**Related Commands:** XTALK:FMAX

**Syntax:** XTALK:FMAX?

**Example:** XTALK:FMAX?

**Response:** FMAX 16.E+3 HZ;

---

**XTALK:FMIN**

Selects the lower frequency display range for the sweep and bargraph displays. The frequency sweep step values will be computed using this value. The HZ unit is optional.

**Related Commands:** XTALK:FMAX, XTALK:FMIN?, GAMplitude, GFREquency, WAVeform

**Syntax:** XTALK:FMIN <nrf> [ HZ ]

**Factory Default:** 20 HZ

**Example:** XTALK:FMIN 100 HZ

---

**XTALK:FMIN?**

Returns the current lower frequency range setting for the sweep and bargraph displays.

**Related Commands:** XTALK:FMAX, XTALK:FMIN?, GAMplitude, GFREquency, WAVeform

**Syntax:** XTALK:FMIN?

**Factory Default:** 20 HZ

**Example:** XTALK:FMIN?

**Response:** FMIN 100. HZ;

---

**XTALK:LUNit**

Selects the level measurement units for the XTALK function. OFF turns off the level measurement display.

**Related Commands:** XTALK:LUNit, REFDBR, REFDBM, REFWatt

**Syntax:** XTALK:LUNit { V | DBV | DBU | DBM | DBR | DBG | W | OFF }

**Factory Default:** V

**Example:** XTALK:LUNIT DBM

---

**XTALK:LUNit?**

Returns the currently selected level measurement units for the XTALK function.

**Related Commands:** XTALK:LUNIT

**Syntax:** XTALK:LUNit?

**Example:** XTALK:LUNIT?

**Response:** LUNIT DBM;

---

**XTALK:MMAx**

Selects the upper magnitude display range for the sweep and bargraph displays in currently selected units. The selected units will be the displayed units only if the bargraph or sweep is being displayed when this command is received.

**Related Commands:** XTALK:MMIN, XTALK:MMAx?

**Syntax:** XTALK:MMAx <nrf> [ V | DBV | DBU | DBM | DBR | DB ]

**Factory Default:** 0 DB

**Example:** XTALK:MMAx 10 DB

---

**XTALK:MMAx?**

Returns the current upper magnitude range setting for the sweep and bargraph displays in currently selected units.

**Related Commands:** XTALK:MMAx

**Syntax:** XTALK:MMAx?

**Example:** XTALK:MMAx?

**Response:** MMAx 10. DB;

---

**XTALK:MMIN**

Selects the lower magnitude display range for the sweep and bargraph displays. The selected units will be the displayed units only if the bargraph or sweep is being displayed when this command is received.

**Related Commands:** XTALK:MMAx

**Syntax:** XTALK:MMIN <nrf> [ V | DBV | DBU | DBM | DBR | DB ]

**Factory Default:** -120 DB

**Example:** XTALK:MMIN -60 DB

---

**XTALK:MMIN?**

Returns the current upper magnitude range setting for the sweep and bargraph displays in currently selected units.

**Related Commands:** XTALK:MMIN

**Syntax:** XTALK:MMIN?

**Example:** XTALK:MMIN?

**Response:** MMIN -60. DB;

---

## XTALK:SET?

Returns the query responses for all the queries under the :XTALK: compound command header. The response is preceded by :DISP GPIB and followed by :DISPLAY *current\_display\_panel*. Equivalent to sending the following query string:

```
XTALK:AMAX?;AMIN?;EXTERNAL?;FMAX?;FMIN?;LUNIT?;MMAX?;MMIN?;SPEED?;STEPS?;SWPTYPE;UNIT?;
```

**Related Commands:** All XTALK: queries

**Syntax:** XTALK:SET?

**Example:** XTALK:SET?

**Response:** :DISP GPIB;:XTALK:AMAX 1. V;AMIN 0. V;EXTERNAL GLIDE;FMAX 20.E+3 HZ;FMIN 20. HZ;LUNIT V;MMAX 0. DB;MMIN -120. DB;SPEED FAST;STEPS 0;SWPTYPE FREQ;UNIT DB;:DISPLAY PANEL;

---

## XTALK:SPEEd

Selects the sweep speed.

**Related Commands:** XTALK:SPEEd?

**Syntax:** XTALK:SPEEd { FAST | MEDium | SLOW }

**Factory Default:** FAST

**Example:** XTALK:SPEED MEDIUM

---

## XTALK:SPEEd?

Returns the currently selected sweep speed.

**Related Commands:** XTALK:SPEEd

**Syntax:** XTALK:SPEEd?

**Example:** XTALK:SPEED?

**Response:** SPEED MEDIUM;

---

## XTALK:STEPS

Selects the sweep mode or the number of sweep steps. A step value of 0 selects the 1/3 octave frequency table if a frequency sweep is desired (SWPTtype is FREQ) or 2 dB steps if an amplitude sweep is desired (SWPTtype is AMPL). A step value of -1 selects the external sweep mode if SWPTtype is FREQ. All other values select the internal sweep mode with the indicated number of steps calculated using the FMIN and FMAX values for frequency sweeps and using the AMIN and AMAX values for amplitude sweeps. STEPS -1 (external sweep) is not permitted if SWPTtype is AMPL.

**Related Commands:** XTALK:EXTernal, XTALK:STEPS?, XTALK:FMIN, XTALK:FMAX

**Syntax:** XTALK:STEPS { -1 | 0 | 3 | 5 | 10 | 15 | 30 | 75 | 150 }

**Factory Default:** 0

**Example:** XTALK:STEPS 3

---

## XTALK:STEPS?

Returns the selected sweep mode or the number of sweep steps selected for the internal sweep mode.

**Related Commands:** XTALK:STEPS

**Syntax:** XTALK:STEPS?

**Example:** XTALK:STEPS?

**Response:** STEPS 3;

---

## XTALK:SWPType

Specifies that either a frequency sweep or amplitude sweep is to be performed when the SWEEP START command is received. Amplitude sweeps and frequency sweeps proceed from high to low (from FMAX to FMIN and from AMIN to AMAX). The type of sweep is dependent on the currently selected generator (ANALOG, DIGITAL, or JITTER) and the currently selected measurement function. The currently displayed or last-selected generator will be used. SWPType AMPL is not permitted if STEPS is -1 (external sweep).

**Related Commands:** GENERator, DGENERator, and measurement function settings STEPS, FMAX, FMIN, AMAX, AMIN, EXTernal

**Syntax:** XTALK:SWPType { FREQ | AMPL }

**Factory Default:** FREQ

**Example:** XTALK:SWPType AMPL

---

## XTALK:SWPType?

Returns the setting of the sweep type, indicating that either a frequency sweep or amplitude sweep is to be performed when the SWEEP START command is received.

**Related Commands:** GENERator, DGENERator, and measurement function settings STEPS, FMAX, FMIN, AMAX, AMIN, EXTernal

**Syntax:** XTALK:SWPType?

**Example:** XTALK:SWPType?

**Response:** SWPType AMPL;

---

## XTALK:UNIT

Selects the XTALK measurement units.

**Related Commands:** XTALK:UNIT?, REFDBM, REFDBR

**Syntax:** XTALK:UNIT { V | DBV | DBU | DBM | DBR | DB }

**Factory Default:** DB

**Example:** XTALK:UNIT V

---

**XTALK:UNIT?**

Returns the currently selected XTALK measurement units.

**Related Commands:** XTALK:UNIT

**Syntax:** XTALK:UNIT?

**Example:** XTALK:UNIT?

**Response:** UNIT V;



# 6. Digital Generator Command Descriptions

This section describes alphabetically the Digital Generator commands, as listed in Section 1. Refer to Section 1 for a list of all commands by command groups, and for command notation and syntax. This section applies to Dual Domain instruments only.

---

## DCAL

Specifies that the DOAMplitude setting should be calibrated for either the bal output (AES/EBU) or the unbal output (SPDIF).

**Group:** Digital Generator Setup

**Related Commands:** DCAL?, DOAMplitude

**Factory Default:** BAL

**Syntax:** DCAL { BAL | UNBAL }

**Example:** DCAL UNBAL

---

## DCAL?

Returns whether the DOAMplitude setting should be calibrated for either the bal output (AES/EBU) or the unbal output (SPDIF).

**Group:** Digital Generator Setup

**Related Commands:** DCAL, DOAMplitude

**Syntax:** DCAL?

**Example:** DCAL?

**Response:** :DCAL UNBAL;

---

## DGAMplitude

Sets the digital audio generator output amplitude in selected units. The default unit is DBFS.

**Group:** Digital Generator Setup

**Related Commands:** DGFRequency

**Syntax:** DGAMplitude <nrf> [ DBFS | FFS ]

**Factory Default:** 0.0 DBFS

**Example:** DGAMPLITUDE 0.75 FFS

---

## DGAMplitude?

Returns the current digital audio generator output amplitude setting and units.

**Group:** Digital Generator Setup

**Related Commands:** DGAMplitude

**Syntax:** GAMPlitude?

**Example:** DGAMPLITUDE?

**Response:** :DGAMPLITUDE 7.5E-1 FFS;

---

## DGFrequency

Sets the digital audio generator sinewave frequency to the specified value when the sinewave waveform is selected with the DWAVE command. The maximum frequency value is limited to 47% of the sample rate specified by the DGRate command, and no error is generated if a higher value is specified. Default units are Hz. Units are optional.

**Group:** Digital Generator Setup

**Related Commands:** DGFrequency?, DGRATE

**Syntax:** DGFrequency <nrf> [ HZ ]

**Factory Default:** 997

**Example:** DGFREQUENCY 997.5 HZ

---

## DGFrequency?

Returns the current digital audio generator sinewave frequency value.

**Group:** Digital Generator Setup

**Related Commands:** DGFrequency, DGRate

**Syntax:** DGFrequency?

**Example** DGFREQUENCY?

**Response:** :DGFREQUENCY 9.975E+2 HZ;

---

## DGRate

Sets the digital audio interface output sample rate in herz units. Range: 28000 to 54000 samples per second for the standard dual domain instrument, 28000 to 99999.9 samples per second for the 96K option of the dual domain instrument. This command interacts with the digital audio sinewave frequency specified by DGFrequency setting by lowering the audio frequency if it is above  $\frac{1}{2}$  the specified sample rate. It also changes the digital audio squarewave frequency when the sample rate is changed.

**Group:** Digital Generator Setup

**Related Commands:** DGRate?, DGFrequency, DGSQrfreq

**Syntax:** DGRate <nrf> [HZ]

**Factory Default:** 48000

**Example:** DGRATE 44105

---

## DGRate?

Returns the current digital audio interface output sample rate in herz units

**Group:** Digital Generator Setup

**Related Commands:** DGRate

**Syntax:** DGRate?

**Example:** DGRATE?

**Response:** :DGRATE 44105. HZ;

---

## DGSQrfreq

Sets the digital audio generator squarewave frequency to the nearest valid frequency. The actual frequency will be the next highest valid frequency dependent on the output sample rate set by the DGRate command. Permissible frequencies will be those frequencies which equal the output sample rate divided by even integers 6 or higher (e.g. highest high frequency is highest sample rate divided by 6, 99.9999 kHz / 6 = 16.66665 kHz, 52.8 kHz / 6 = 8.8 kHz, lowest high frequency is lowest sample rate divided by 6, 28.8 kHz / 6 = 4.8 kHz). This command does not affect the frequency setting of the sinewave waveform. Default units are Hz. Units are optional. The minimum frequency is 10 Hz. Values outside the settable range will be coerced to within the range, and no errors will be reported.

**Group:** Digital Generator Setup

**Related Commands:** DGSQrfreq?, DGRate

**Syntax:** DGSQrfreq <nrf> [ HZ ]

**Factory Default:** 1 KHZ

**Example:** DGSQRFREQ 470 HZ

---

## DGSQrfreq?

Returns the current digital audio generator squarewave frequency value.

**Group:** Digital Generator Setup

**Related Commands:** DGSQrfreq

**Syntax:** DGSQrfreq?

**Example:** DGSQRFREQ?

**Response:** :DGSQRFREQ 4.70588E+2 HZ;

---

## DIMHf

Selects the digital audio generator IMD high frequency tone for the IMD waveform. The numeric argument will be interpreted to be the nearer of the two valid frequencies in Hz units and will not generate an error if not set to exactly 7000 or 8000.

**Group:** Digital Generator Setup

**Related Commands:** DIMHf?, FUNCTion, DWAVEform

**Syntax:** DIMDHF <nrf>

**Factory Default:** 7000

**Example:** DIMHF 7000

---

## DIMHf?

Returns the digital audio generator IMD high frequency tone for the IMD waveform.

**Group:** Digital Generator Setup

**Related Commands:** DIMHf, FUNCtion, DWAVEform

**Syntax:** DIMHf?

**Example:** DIMHf?

**Response:** :DIMHF 7000.;

---

## DIMLf

Selects the digital audio generator IMD low frequency tone for the IMD waveform. The numeric argument will be interpreted to be the nearest of the valid frequencies in Hz units ( 50, 60, 70, or 250 Hz).

**Group:** Digital Generator Setup

**Related Commands:** DIMLf?, FUNCtion, DWAVEform

**Syntax:** DIMLF <nrf>

**Factory Default:** 60

**Example:** DIMLF 50

---

## DIMLf?

Returns the digital audio generator IMD low frequency tone for the IMD waveform.

**Group:** Digital Generator Setup

**Related Commands:** DIMLf, FUNCtion, WAVEform

**Syntax:** DIMLf?

**Example:** DIMLf?

**Response:** :DIMLF 50.;

---

## DITHer

Selects the type of dither applied to both channels of the digital audio data on the digital outputs. Choices are: none (NONE), rectangular (RECT), shaped (SHAP), or triangular (TRI).

**Group:** Digital Generator Setup

**Related Commands:** DITHer?

**Syntax:** DITHer { NONE | RECT | SHAP | TRI }

**Factory Default:** NONE

**Example:** DITHer TRI

---

## DITHer?

Returns the currently selected type of dither applied to digital audio data on the digital outputs: none (NONE), rectangular (RECT), shaped (SHAP), or triangular (TRI).

**Group:** Digital Generator Setup

**Related Commands:** DITHer

**Syntax:** DITHer?

**Example:** DITHER?

**Response:** :DITHER TRI;

---

## DOAMplitude

Sets the pulse amplitude in Vpp units of either the bal or unbal digital output interface bit stream. The output will be calibrated for either the bal (AES/EBU) or unbal (SPDIF) output connector depending on the setting of the DCAL command. Range is dependent on which output connector is selected by the DCAL command: 0 – 5.11 Vpp for the bal output, 0 – 1.62 Vpp for the unbal output. The argument value will be coerced to within range and no error will be reported. Vpp units are optional.

**Group:** Digital Generator Setup

**Related Commands:** DOAMplitude?, DCAL

**Syntax:** DOAMplitude <nrf> [VPP]

**Factory Default:** 5.00 Vpp

**Example:** DOAMPLITUDE 2.55 VPP

---

## DOAMplitude?

Returns the pulse amplitude in Vpp units of either the bal or unbal digital output interface bit stream, depending on the setting of the DCAL command.

**Group:** Digital Generator Setup

**Related Commands:** DOAMplitude, DCAL

**Syntax:** DOAMplitude?

**Example:** DOAMPLITUDE?

**Response:** :DOAMPLITUDE 2.55 VPP;

---

## DOResolution

Selects the number of data bits of resolution applied to both channels of the digital audio data on the digital outputs. Resolution is specified in bits from 16 to 24 in even numbers: 16, 18, 20, 22, 24. The numeric argument must be exact or an error will be generated. This also sets the level of dither if it is enabled with the DITHer command.

**Group:** Digital Generator Setup

**Related Commands:** DOResolution?

**Syntax:** DOResolution <nr1>

**Factory Default:** 24

**Example:** DORESOLUTION 22

---

## DOResolution?

Returns the currently selected number of data bits of resolution applied to both channels of the digital audio data on the digital outputs.

**Group:** Digital Generator Setup

**Related Commands:** DOResolution

**Syntax:** DOResolution?

**Example:** DORESOLUTION?

**Response:** :DOResolution 22;

---

## DOUTput

Enables digital audio generator output channels. Selecting channel A enables channel A output data and does not affect the channel B output data, and vice-versa. Selecting OFF disables both A and B output data. Selecting ON enables data for both channels.

The digital audio interface bit stream is not disabled with this command. A channel that is disabled transmits only digital zeros. The presence of dither is unaffected by this command, therefore a channel that is disabled may still have a measurable signal if dither is specified by the DITHer command.

**Group:** Digital Generator Setup

**Related Commands:** DOUTput?

**Syntax:** DOUTput { OFF | ON | A | B }

**Factory Default:** OFF

**Example:** DOUTPUT ON

---

## DOUTput?

Returns the current state of the digital audio generator data outputs: OFF, ON, A, or B.

**Group:** Digital Generator Setup

**Related Commands:** DOUTput

**Syntax:** DOUTput?

**Example:** DOUTPUT?

**Response:** :DOUTPUT ON;

---

## DSRef

Enables synchronization of the digital generator output signal with respect to the rear panel Digital Reference Input signal. The NREF argument (-REF) causes the digital generator output signal to lead the signal on the rear panel Digital Reference Input by the number of unit intervals (UI) specified by the DSYNch command. The PREF argument (+REF) causes the digital generator output signal to lag the signal on the rear panel Digital Reference Input by the number of unit intervals (UI) specified by the DSYNch command. The OFF argument disables synchronization.

**Group:** Digital Generator Setup

**Related Commands:** DSYNch, DSRef?

**Syntax:** DSRef { OFF | NREF | PREF }

**Example:** DSREF PREF

---

## DSRef?

Returns the settings of the DSRef command which enables or disables the digital generator output signal synchronization with respect to the rear panel Digital Reference input signal.

**Group:** Digital Generator Setup

**Related Commands:** DSRef

**Syntax:** DSRef?

**Example:** DSREF?

**Response:** :DSREF PREF;

---

## DSYNch

Specifies the amount of delay of the digital generator output with respect to the Digital Reference input signal when the digital synch reference is set to NREF (-REF leads the reference input signal) or PREF (+REF lags the reference input signal) with the DSRef command. It specifies the amount of delay in UI units in fixed increments of 0.0, +0.5, +1, +5, +10, +50 UI. The numeric argument will be rounded to the nearest fixed increment and must be in the range 0.0 to +50 inclusive or a command error will be generated. Setting synch delay to 0.0 UI does not turn synch ref OFF (the output is still synchronized to the reference input signal). Use DSREF OFF to turn the sync ref off.

The actual value of delay is set to 0.0 UI when the PASS waveform is enabled, but reverts to its original value when any other waveform is enabled with DSREF ON.

**Group:** Digital Generator Setup

**Related Commands:** DSYNch?, DSRef

**Syntax:** DSYNch <nrf>

**Example:** DSYNCH 10

---

## DSYNch?

Returns the settings of the digital generator output signal synchronization with respect to the rear panel Digital Reference input signal. See DSYNCH above.

**Group:** Digital Generator Setup

**Related Commands:** DSYNch

**Syntax:** DSYNch?

**Example:** DSYNCH?

**Response:** :DSYNCH 10;

---

## DWAVEform

Selects the digital audio generator waveform for output. Overrides the generator settings resulting from selecting a measurement function. A measurement function enabled after this command may set the waveform differently (refer to the section beginning on page 1-20 for further information).

**Group:** Digital Generator Setup

**Related Commands:** FUNCTION, DGFRrequency, DGAMplitude

**Syntax:** DWAVEform { SINE | SQUARE | IMD | RAND | JTEST | PASS }

**Factory Default:** SINE

**Example:** DWAVEFORM SQUARE

---

## DWAVeform?

Returns the current digital audio generator waveform setting resulting from the DWAVeform command or a FUNcTION setting.

**Group:** Digital Generator Setup

**Related Commands:** FUNcTION, DGFRequency, DGAMplitude

**Syntax:** DWAVeform?

**Example:** DWAVEFORM?

**Response:** :DWAVEFORM SQUARE;

---

## JAMPlitude

Sets the digital audio generator jitter amplitude in UI (unit intervals) or SEC (seconds) units. If no unit is specified, UI is assumed, and the JAMP display is set to UI. The amplitude range in unit intervals is 0.0 to 12.75 UI. The amplitude range in seconds is dependent on sample rate (e.g. 0.0 sec to 3.4586 sec at 28.8 ksamples/sec rate, or 0.0 sec to 1.8865 sec at 52.8 ksamples/sec rate). The jitter amplitude is set to zero UI when the JWAVeform command is set to OFF, but returns to the programmed value when JWAVeform is set to SINE.

**Group:** Digital Generator Setup

**Related Commands:** JAMPlitude?, JFRequency, JWAVeform, GENerator

**Syntax:** JAMPlitude <nrf> [ UI | SEC ]

**Factory Default:** 0.0 UI

**Example:** JAMPLITUDE 0.5 UI

---

## JAMPlitude?

Returns the current digital audio generator jitter amplitude setting in UI or SEC units.

**Group:** Digital Generator Setup

**Related Commands:** JAMPlitude, JWAVeform, JFRequency, GENerator

**Syntax:** JAMPlitude?

**Example:** JAMPLITUDE? UI

**Response:** :JAMPLITUDE 5.0E-1 UI;

---

## JFRequency

Sets the digital audio generator jitter sinewave frequency to the specified value. Default units are Hz. Units are optional. Range: 10.0 to 38800 Hz.

**Group:** Digital Generator Setup

**Related Commands:** JFRequency?, JWAVeform, JAMPlitude, GENerator

**Syntax:** JFRequency <nrf> [ HZ ]

**Factory Default:** 1000.2 Hz

**Example:** JFREQUENCY 152.1 HZ

---

## JFRequency?

Returns the current digital audio generator jitter frequency value.

**Group:** Digital Generator Setup

**Related Commands:** JFRequency, JWAVeform, JAMPlitude, GENerator

**Syntax:** JFREquency?

**Example** JFREQUENCY?

**Response:** :JFREQUENCY 1.521E+2 HZ;

---

## JWAVeform

Sets the digital audio generator jitter waveform to SINE or OFF.

**Group:** Digital Generator Setup

**Related Commands:** JWAVeform?, JAMPlitude, JFREquency, GENerator

**Syntax:** JWAVeform { SINE | OFF }

**Factory Default:** OFF

**Example:** JWAVEFORM SINE

---

## JWAVeform?

Returns the current digital audio generator jitter waveform setting.

**Group:** Digital Generator Setup

**Related Commands:** JWAVeform, JAMPlitude, JFREquency, GENerator

**Syntax:** JWAVEform?

**Example** JWAVEFORM?

**Response:** :JWAVEFORM SINE;

# 7. Digital Analyzer Command Descriptions

This section describes alphabetically the Digital Analyzer commands for the Dual Domain instrument, as listed in Section 1. Refer to Section 1 for a list of all commands by command groups, and for command notation and syntax. This section applies to Dual Domain instruments only.

---

## DHOLD

Holds the digital analyzer input ranges at the present range setting and enables or disables digital analyzer input auto-ranging.

DHOLD ON disables auto-ranging and holds the digital A and B input ranges at their present range values if the previous state was OFF. Use DHOLD ON with the DRGA and DRGB commands to set specific fixed input ranges. Receipt of a FUNCTION command will re-enable auto-ranging and set DHOLD to OFF.

DHOLD OFF enables auto-ranging if the previous state was DHOLD ON.

**Related Commands:** DHOLD?, DRGA, DRGB, FUNCTION

**Syntax:** DHOLD { ON | OFF }

**Example:** DHOLD ON

---

## DHOLD?

Returns the setting of the DHOLD command that indicates the state of the digital analyzer input ranges.

A response of DHOLD ON indicates that the digital analyzer inputs are at fixed ranges and that auto-ranging is disabled.

A response of DHOLD OFF indicates that the digital analyzer inputs are in auto-ranging mode.

DHOLD OFF enables auto-ranging if the previous state was DHOLD ON.

**Related Commands:** DHOLD

**Syntax:** DHOLD?

**Example:** DHOLD?

**Response:** :DHOLD ON;

---

## DINPut

Selects the Digital Analyzer input channels to be measured for digital audio and digital interface measurements. Stores the setting but does not execute it if an analog measurement function is currently selected. The digital input setting will be restored when a digital measurement function is selected.

A and B select the external digital input (XLR, unbalanced, or TOSLINK connector) for audio measurement functions and digital interface parameter measurements. GAGB and GBGA select the internal digital generator output monitor for audio measurement functions and digital interface parameter measurements. The table

below lists how the channels are connected for different digital measurement functions.

Function	A (External Input)	B (External Input)	GAGB (Generator Output)	GBGA (Generator Output)
AMPLITUDE	M1: Amplitude A M3: Freq A	M1: Amplitude B M3: Freq B	M1: Amplitude A M3: Freq A	M1: Amplitude B M3: Freq B
NOISE	M1: Noise A	M1: Noise B	M1: Noise A	M1: Noise B
THD+N	M1: THD+N A M2: Level A	M1: THD+N B M2: Level B	M1: THD+N A M2: Level A	M1: THD+N B M2: Level B
IMD	M1: IMD A M2: Level A	M1: IMD B M2: Level B	M1: IMD A M2: Level A	M1: IMD B M2: Level B
JITTER	External Input	External Input	Generator Output	Generator Output
DIO	External Input	External Input	Generator Output	Generator Output
LEVEL	M1: Level A M2: Level B M3: Freq A or Phase A-B	M1: Level B M2: Level A M3: Freq B or Phase B-A	M1: Level A M2: Level B M3: Freq A or Phase A-B	M1: Level B M2: Level A M3: Freq B or Phase B-A
PHASE	M1: Phase A-B M2: Level B M3: Freq B	M1: Phase B-A M2: Level A M3: Freq A	Invalid	Invalid
RATIO	M1: Ratio A/B M2: Level B M3: Freq B or Phase A-B	M1: Ratio B/A M2: Level A M3: Freq A or Phase B-A	Invalid	Invalid
XTALK	M1: Crosstalk A M2: Level B M3: Freq B	M1: Crosstalk B M2: Level A M3: Freq A	Invalid	Invalid
DATACHECK	External Input	External Input	Generator Output	Generator Output

**Related Commands:** FUNCtion

**Syntax:** DINPut { A | B | GAGB | GBGA }

**Factory Default:** A

**Example:** DINPUT A

---

## DINPut?

Returns the current selected Digital Analyzer input channel.

**Related Commands:** FUNCtion

**Syntax:** DINPut?

**Example:** DINPUT?

**Response** :DINPUT A;

---

## DREFdbr

Sets the Digital Analyzer dBr reference value in designated units. The default unit is FFS if no unit is specified. Optional units are FFS and DBFS. Range in FFS is 1E-8 to 1.00.

**Related Commands:** DREFdbr?, DBRzero

**Syntax:** DREFdbr <nrf> [ FFS | DBFS ]

**Factory Default:** 1 FFS

**Example:** DREFDBR -60.0 DBFS;

---

## DREFdbr?

Returns the current Digital Analyzer dBr reference value in FFS units.

**Related Commands:** DREFdbr, DBRzero

**Syntax:** DREFdbr?

**Example:** DREFDBR?

**Response:** :DREFDBR 1.0E-3 FFS;

---

## DRGA

Sets the Digital Analyzer channel A input to a valid range in units of dBFS equal to or greater than the numeric argument. Full scale range is equal to 0.0 dBFS (1.000 FFS). Ranges are increments of -6.02 dBFS (1 bit per range step). If autoranging is in hold mode (DHOLD ON), the input range will be set to the new range and held there. If autoranging is enabled (DHOLD OFF), the input range will be set to the new range and then allowed to change range under the control of the autoranging system. Autoranging is enabled if a DHOLD OFF command is received, if a FUNCTION command is received, or if the instrument returns to the LOCAL mode because a front panel button was pressed.

Note that autoranging is a time-consuming process that may require use of the DELAY command to pace command execution. This helps assure that autoranging is complete before attempting measurements or range queries.

**Related Commands:** DHOLD, FUNCtion

**Syntax:** DRGA <nrf>

**Example:** DRGA -55.5

---

## DRGA?

Returns the current Digital Analyzer channel A input range, whether autoranging or in range hold mode.

**Related Commands:** DHOLD, FUNCtion

**Syntax:** DRGA?

**Example:** DRGA?

**Response:** :DRGA -54.18;

---

## DRGB

Sets the Digital Analyzer channel B input to a valid range in units of dBFS equal to or greater than the numeric argument. Full scale range is equal to 0.0 dBFS (1.000 FFS). Ranges are increments of -6.02 dBFS (1 bit per range step). If autoranging is in hold mode (DHOLD ON), the input range will be set to the new range and held there. If autoranging is enabled (DHOLD OFF), the input range will be set to the new range and then allowed to change range under the control of the autoranging system. Autoranging is enabled if a DHOLD OFF command is received, if a FUNCTION command is received, or if the instrument returns to the LOCAL mode because a front panel button was pressed.

**Note that autoranging is a time-consuming process that may require use of the DELAY command to pace command execution. This helps assure that autoranging is complete before attempting measurements or range queries.**

**Related Commands:** DHOLD, FUNCtion

**Syntax:** DRGB <nrf>

**Example:** DRGB -55.5

---

## DRGB?

Returns the current Digital Analyzer channel B input range, whether autoranging or in range hold mode.

**Related Commands:** DHOLD, FUNCtion

**Syntax:** DRGB?

**Example:** DRGB?

**Response:** :DRGB -54.18;

---

## DZIN

Selects LOW (110 AES/EBU XLR connector or 75 SPDIF BNC unbal connector) or HIGH impedance bridging termination for the digital input connectors.

**Related Commands:** DZIN?

**Syntax:** DZIN { LOW | HIGH }

**Factory Default:** HIGH

**Example:** DZIN LOW

---

## DZIN?

Returns the current selected low or high impedance termination for the digital input connectors.

**Related Commands:** DZIN

**Syntax:** DZIN?

**Example:** DZIN?

**Response:** DZIN LOW;

---

## DAMplitude:

Compound command header for the Digital Amplitude measurement function.

---

### DAMplitude:AMAX

This command sets the maximum amplitude level for an amplitude sweep of the analog generator, the digital generator, or the jitter generator when the SWPType command is set to AMPL.

Set the generator type and unit before sending the AMAX command. Subsequent changes to the generator type may cause the AMAX setting to be changed.

The numeric argument and its unit should be within the valid amplitude range of the generator and its waveform type. The maximum level for an amplitude sweep will be the argument value and units for the generator last selected with the GENERator command or selected by the user with the front panel OUTPUT button.

If the AMAX argument value is less than the current setting of the AMIN command but within the range of the generator, then the AMIN command setting will be coerced to a lower value and no error will be generated.

Error 4 “CONFLICT WITH MAXIMUM AMPLITUDE” will be generated if the argument is outside of the range of the generator.

See Section 1 General Information – Sweeps for more information about interactions between amplitude sweep parameters and changes of the currently selected generator.

**Related Commands:** DAMplitude:AMIN, DAMplitude:AMAX?, DAMplitude:SWPType

**Syntax:** DAMplitude:AMAX <nrf> unit

**Factory Default:** 1.0

**Example:** DAMPLITUDE:AMAX 0. DBFS

---

### DAMplitude:AMAX?

Returns the maximum amplitude level set by the AMAX command.

**Related Commands:** DAMplitude:AMAX

**Syntax:** DAMplitude:AMAX?

**Example:** DAMPLITUDE:AMAX?

**Response:** AMAX 0. DBFS;

---

### DAMplitude:AMIN

This command sets the minimum amplitude level for an amplitude sweep of the analog generator, the digital generator, or the jitter generator when the SWPType command is set to AMPL.

Set the generator type and unit before sending the AMIN command with compatible units. Subsequent changes to the generator may cause the AMIN setting to be changed.

The numeric argument and its unit should be within the valid amplitude range of the generator and its waveform type. The

minimum level for an amplitude sweep will be the argument value and units for the generator last selected with the GENERator command or selected by the user with the front panel OUTPUT button.

If the AMIN argument value is greater than the current setting of the AMAX command but within the range of the generator, then the AMAX command setting will be coerced to a higher value and no error will be generated.

Error 5 “CONFLICT WITH MINIMUM AMPLITUDE” will be generated if the argument is outside of the range of the generator.

See Section 1 General Information – Sweeps for more information about interactions between amplitude sweep parameters and changes of the currently selected generator.

**Related Commands:** DAMplitude:AMIN?, DAMplitude:AMAX, DAMplitude:SWPType  
**Syntax:** DAMplitude:AMIN <nrf> unit  
**Factory Default:** 0.0  
**Example:** DAMPLITUDE:AMIN -140. DBFS

## DAMplitude:AMIN?

Returns the minimum amplitude level set by the AMIN command.

**Related Commands:** DAMplitude:AMIN  
**Syntax:** DAMplitude:AMIN?  
**Example:** DAMPLITUDE:AMIN?  
**Response:** AMIN -140. DBFS;

## DAMplitude:BPFR

Selects the center frequency for the tunable bandpass filter when the Selective filter is selected. The HZ unit is optional.

**Related Commands:** DAMplitude:FILTER, DAMplitude:BPFR?  
**Syntax:** DAMplitude:BPFR <nrf> [ HZ ]  
**Factory Default:** 1000  
**Example:** DAMPLITUDE:BPFR 2500

## DAMplitude:BPFR?

Returns the tunable bandpass filter center frequency.

**Related Commands:** DAMplitude:BPFR  
**Syntax:** DAMplitude:BPFR?  
**Example:** DAMPLITUDE:BPFR?  
**Response:** BPFR 2.5E+3 HZ;

---

## DAMplitude:EXternal

Selects glide or step settling in external sweep mode.

**Related Commands:** DAMplitude:STEP, DAMplitude:EXternal?

**Syntax:** DAMplitude:EXternal { GLIDE | STEP }

**Factory Default:** GLIDE

**Example:** DAMPLITUDE:EXTERNAL STEP

---

## DAMplitude:EXternal?

Returns the current external sweep settling mode.

**Related Commands:** DAMplitude:EXternal

**Syntax:** DAMplitude:EXternal?

**Example:** DAMPLITUDE:EXTERNAL?

**Response:** EXTERNAL STEP;

---

## DAMplitude:FILTER

Selects the filter for the Amplitude function, identical to the front-panel selection.

**Related Commands:** DAMplitude:BPFR, DAMplitude:WTD, DAMplitude:FILTER, DAMplitude:HPASs, DAMplitude:LPASs

**Factory Default:** UNWTD

**Syntax:** DAMplitude:FILTER { SElective | WTD | UNWTD }

**Example:** DAMPLITUDE:FILTER WTD

---

## DAMplitude:FILTER?

Returns the current filter for the Amplitude function.

**Related Commands:** DAMplitude:FILTER

**Syntax:** DAMplitude:FILTER?

**Example:** DAMPLITUDE:FILTER?

**Response:** FILTER WTD;

---

## DAMplitude:FMAX

Selects the upper frequency display range for the sweep display. The frequency sweep step values will be computed using this value. The HZ unit is optional.

**Related Commands:** DAMplitude:FMIN, DAMplitude:FMAX?

**Syntax:** DAMplitude:FMAX <nrf> [ HZ ]

**Factory Default:** 20000 HZ

**Example:** DAMPLITUDE:FMAX 22 KHZ

---

## DAMplitude:FMAX?

Returns the current upper frequency range setting for the sweep display.

**Related Commands:** DAMplitude:FMAX

**Syntax:** DAMplitude:FMAX?

**Example:** DAMPLITUDE:FMAX?

**Response:** FMAX 22.E+3 HZ;

---

## DAMplitude:FMIN

Selects the lower frequency display range for the sweep display. The frequency sweep step values will be computed using this value. The HZ unit is optional.

**Related Commands:** DAMplitude:FMAX, DAMplitude:FMIN?

**Syntax:** DAMplitude:FMIN <nrf> [ HZ ]

**Factory Default:** 20 HZ

**Example:** DAMPLITUDE:FMIN 100

---

## DAMplitude:FMIN?

Returns the current lower frequency range setting for the sweep display.

**Related Commands:** DAMplitude:FMIN

**Syntax:** DAMplitude:FMIN?

**Example:** DAMPLITUDE:FMIN?

**Response:** FMIN 100. HZ;

---

## DAMplitude:HPASS

Selects the high pass filter cut off frequency. Values of 10 Hz, 22 Hz, or 400 Hz may be selected. The filter cut off frequencies are valid only for the standard sampling rates of 32 KHz, 44.1 KHz, 48 KHz, 88.2 KHz, and 96 KHz.

**Related Commands:** DAMplitude:FILTer, DAMplitude:LPASs, DAMplitude:HPASs?

**Syntax:** DAMplitude:HPASs [ HP10 | HP22 | HP400 ]

**Factory Default:** HP10

**Example:** DAMPLITUDE:HPASS HP22

---

## DAMplitude:HPASS?

Returns the high pass filter cut off frequency setting.

**Related Commands:** DAMplitude:HPASs

**Syntax:** DAMplitude:HPASs?

**Example:** DAMPLITUDE:HPASS?

**Response:** HPASS HP22;

---

## DAMplitude:LPASS

Selects the band pass filter cut off frequency and detector when the unweighted filter is selected. Selections are: 15 kHz RMS (R15k), 20 kHz RMS (R20k), Half Sample Rate (HALFrate), 22 kHz RMS (R22k), 22 kHz QPEAK (Q22k). The filter cut off frequencies are valid only for the standard sampling rates of 32 KHz, 44.1 KHz, 48 KHz, 88.2 KHz, and 96 KHz.

**Related Commands:** DAMplitude:FILTer, DAMplitude:HPASSs, DAMplitude:LPASSs?

**Syntax:** DAMplitude:LPASSs { R15k | R20k | HALFrate | R22k | Q22k }

**Factory Default:** R20K

**Example:** DAMPLITUDE:LPASS Q22K

---

## DAMplitude:LPASSs?

Returns the current low pass filter setting and detector selection to be used when the UNWTD filter is selected.

**Related Commands:** DAMplitude LPASSs

**Syntax:** DAMplitude:LPASSs?

**Example:** DAMPLITUDE:LPASS Q22K

**Response:** LPASS Q22K;

---

## DAMplitude:MMAx

Selects the upper magnitude display range for the sweep and bargraph displays in currently selected units. The selected units will be the displayed units only if the bargraph or sweep is being displayed when this command is received.

**Related Commands:** DAMplitude:MMIN, DAMplitude:MMAx?

**Syntax:** DAMplitude:MMAx <nrf> [ FFS | DBFS | DBR ]

**Factory Default:** 1.0 FFS

**Example:** DAMPLITUDE:MMAx -10 DBFS

---

## DAMplitude:MMAx?

Returns the current upper magnitude range setting for the sweep and bargraph displays in currently selected units.

**Related Commands:** DAMplitude:MMAx

**Syntax:** DAMplitude:MMAx?

**Example:** DAMPLITUDE:MMAx?

**Response:** MMAx -10. DBFS;

---

## DAMplitude:MMIN

Selects the lower magnitude display range for the sweep display. The selected units will be the displayed units only if the bargraph or sweep is being displayed when this command is received.

**Related Commands:** DAMplitude:MMAx, DAMplitude:MMIN?

**Syntax:** DAMplitude:MMIN <nrf> [ FFS | DBFS | DBR ]

**Factory Default:** 1E-7 FFS

**Example:** DAMPLITUDE:MMIN -120 DBFS

---

## DAMplitude:MMIN?

Returns the current upper magnitude range setting for the sweep and bargraph displays in currently selected units.

**Related Commands:** DAMplitude:MMIN  
**Syntax:** DAMplitude:MMIN?  
**Example:** DAMPLITUDE:MMIN?  
**Response:** MMIN -120 DBFS;

---

## DAMplitude:SET?

Returns the query responses for all the queries under the :DAMP: compound command header. The response is preceded by :DISP GPIB and followed by :DISPLAY *current\_display\_panel*. Equivalent to sending the following query string:

```
:DAMPLITUDE:AMAX?;AMIN?;BPFR?;EXTERNAL?;FILTER?;F
MAX?;FMIN?;HPASS?;LPASS?;MMAX?;MMIN?;SPEED?;STEPS
?;SWPTYPE?;UNIT?;WTD?;:DISPLAY?
```

**Related Commands:** All DAMplitude: queries  
**Syntax:** DAMplitude:SET?  
**Example:** DAMPLITUDE:SET?  
**Response:** :DISP GPIB;:DAMPL:AMAX 0. DBV;AMIN -999.
DBV;BPFR 1.E+3 HZ;EXTERNAL GLIDE;FILTER
UNWTD;FMAX 20.E+3 HZ;FMIN 20. HZ;HPASS
HP10;LPASS HALFRATE;MMAX 0. DBFS;MMIN -120.
DBFS;SPEED FAST;STEPS 0;SWPTYPE FREQ;UNIT
DBFS;WTD IECA;:DISPLAY PANEL;

---

## DAMplitude:SPEEd

Selects the sweep speed.

**Related Commands:** DAMplitude:SPEEd?  
**Syntax:** DAMplitude:SPEEd { FAST | MEDium | SLOW }  
**Factory Default:** FAST  
**Example:** DAMPLITUDE:SPEED MEDIUM

---

## DAMplitude:SPEEd?

Returns the currently selected sweep speed.

**Related Commands:** DAMplitude:SPEEd  
**Syntax:** DAMplitude:SPEEd?  
**Example:** DAMPLITUDE:SPEED?  
**Response:** SPEED MEDIUM;

---

## DAMplitude:STEPS

Selects the sweep mode or the number of sweep steps. A step value of 0 selects the 1/3 octave frequency table if a frequency sweep is desired (SWPType is FREQ) or 2 dB steps if an amplitude sweep is desired (SWPType is AMPL). A step value of -1 selects the external sweep mode if SWPType is FREQ. All other values select the internal sweep mode with the indicated number of steps calculated using the FMIN and FMAX values for frequency sweeps and using the AMIN and AMAX values for amplitude sweeps. STEPS -1 (external sweep) is not permitted if SWPType is AMPL.

**Related Commands:** DAMplitude:EXternal, DAMplitude:STEP, DAMplitude:FMIN, DAMplitude:FMAX

**Syntax:** DAMplitude:STEP { -1 | 0 | 3 | 5 | 10 | 15 | 30 | 75 | 150 }

**Factory Default:** 0

**Example:** DAMPLITUDE:STEP 3

---

## DAMplitude:STEPS?

Returns the selected sweep mode or the number of sweep steps selected for the internal sweep mode.

**Related Commands:** DAMplitude:STEP

**Syntax:** DAMplitude:STEPS?

**Example:** DAMPLITUDE:STEPS?

**Response:** STEP 3;

---

## DAMplitude:SWPType

Specifies that either a frequency sweep or amplitude sweep is to be performed when the SWEEP START command is received. Amplitude sweeps and frequency sweeps proceed from high to low (from FMAX to FMIN and from AMIN to AMAX). The type of sweep is dependent on the currently selected generator (ANALOG, DIGITAL, or JITTER) and the currently selected measurement function. The currently displayed or last-selected generator will be used. SWPType AMPL is not permitted if STEPS is -1 (external sweep).

**Related Commands:** GENerator, DGENerator, and measurement function settings STEP, FMAX, FMIN, AMAX, AMIN, EXternal

**Syntax:** DAMplitude:SWPType { FREQ | AMPL }

**Factory Default:** FREQ

**Example:** DAMplitude:SWPTYPE AMPL

---

## DAMplitude:SWPType?

Returns the setting of the sweep type, indicating that either a frequency sweep or amplitude sweep is to be performed when the SWEEP START command is received.

**Related Commands:** GENerator, DGENerator, and measurement function settings STEP, FMAX, FMIN, AMAX, AMIN, EXTernal

**Syntax:** DAMplitude:SWPType?

**Example:** DAMplitude:SWPTYPE?

**Response:** SWPTYPE AMPL

---

## DAMplitude:UNIT

Selects the measurement units for the Digital Amplitude function.

**Related Commands:** REFDBR, DAMplitude:UNIT?

**Syntax:** DAMplitude:UNIT { FFS | DBFS | DBR }

**Factory Default:** DBFS

**Example:** DAMPLITUDE:UNIT DBFS

---

## DAMplitude:UNIT?

Returns the current units for the Digital Amplitude function.

**Related Commands:** DAMplitude:UNIT

**Syntax:** DAMplitude:UNIT?

**Example:** DAMPLITUDE:UNIT?

**Response:** UNIT DBFS;

---

## DAMplitude:WTD

Selects the weighting filter for the Digital Amplitude function when the WTD filter is selected. The choices are the same ones available from the front panel.

**Related Commands:** DAMplitude:FILTer, DAMplitude:WTD?

**Syntax:** DAMplitude:WTD { IECA | RMSCcir | CCIR2K | QPKCcir }

**Factory Default:** IECA

**Example:** DAMPLITUDE:WTD RMSCCIR

---

## DAMplitude:WTD?

Returns the currently selected weighting filter for the Digital Amplitude function.

**Related Commands:** DAMplitude:WTD

**Syntax:** DAMplitude:WTD?

**Example:** DAMPLITUDE:WTD?

**Response:** WTD RMSCCIR;

## DCHK:

Compound command header for the Digital Interface Data Check measurement function.

### DCHK:BITS?

This query returns two 32-bit decimal integers (only the low 24 bits are available, the top 8 bits are not used) indicating the state of the digital input signal on the A and B channels. In Active Bits mode, each bit position in the response will be set if the corresponding bit has changed since the last measurement cycle. In Actual Bits mode, each bit position in the response reflects the state of the corresponding bit in the digital input signal.

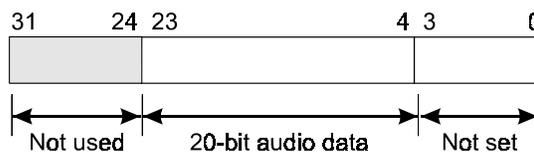

Figure 7-1. Example format for 20-bit audio data

The left-most available bit (bit 23) corresponds to the Most Significant Bit (MSB) of the digital input signal. The professional and consumer standards allow for up to 24-bit wide signals. When less than 24 bits are transmitted, the standards call for the digital audio data to be MSB-justified. Thus, a 20-bit input signal (see diagram above) will set the 20 left-most bits (23 through 4), but bits 3 through 0 will not be set since they do not contain changing data.

The response returns the A channel bits integer followed by the B channel bits integer. For example, if all 24 bits are active ( $n = 24$ ), then the response will be  $(2^{24} - 1) = 16777215$ . If only 20 bits are active, the response will be  $(2^{24} - 1) - (2^{24 - 20} - 1) = 2^{24} - 2^2 = 16777200$ . If only 16 bits are active, the response will be  $(2^{24} - 1) - (2^{24 - 16} - 1) = 2^{24} - 2^8 = 16776960$ ; etc.

An execution error will be reported if the current measurement function is not DCHK.

**Related Commands:** :DCHK:DBITs, FUNCtion

**Syntax:** :DCHK:BITs?

**Response Syntax:** BITs **abits**, **bbits**

**Example:** :DCHK:BITs?

**Response:** BITs 16777215, 32

### DCHK:DBITs

Selects the measurement mode for the digital interface data bits, either Active Bits mode (ACTV) or Actual Bits mode (ACTL). Affects the response to the BITs? Query.

**Related Commands:** DCHK:DBITs?

**Syntax:** DCHK:DBITs { ACTV | ACTL }

**Factory Default:** ACTIVE

**Example:** :DCHK:DBITs ACTL

---

**DCHK:DBITs?**

Returns the measurement mode for the digital interface data bits, either Active Bits mode (ACTV) or Actual Bits mode (ACTL).

**Related Commands:** DCHK:DBITs  
**Syntax:** DCHK:DBITs?  
**Example:** DCHK:DBITs?  
**Response:** DBITS ACTL;

---

**DCHK:DUNit**

Selects the data units for the data display, either decimal (DEC) or hexadecimal (HEX). The choice of unit affects the format of the response to the :M3? query.

**Related Commands:** DCHK:DUNit?  
**Syntax:** DCHK:DUNit { DEC | HEX }  
**Factory Default:** HEX  
**Example:** DCHK:DUNIT DEC

---

**DCHK:DUNit?**

Returns the currently selected data units for the data display, either decimal (DEC) or hexadecimal (HEX).

**Related Commands:** DCHK:DUNit  
**Syntax:** DCHK:DUNit?  
**Example:** DCHK:DUNIT?  
**Response:** DUNIT DEC;

---

**DCHK:MMAx**

Selects the upper magnitude display range and units for the bargraph display.

**Related Commands:** DCHK:MMAx?, DCHK:MMIN  
**Syntax:** DCHK:MMAx <nrf> [ NORM | TOTAL ]  
**Factory Default:** 1000 NORM  
**Example:** DCHK:MMAx 20000 TOTAL

---

**DCHK:MMAx?**

Returns the current upper magnitude range setting for the bargraph display in currently selected units.

**Related Commands:** DCHK:MMAx  
**Syntax:** DCHK:MMAx?  
**Example:** DCHK:MMAx?  
**Response:** MMAx 2.0E+4 TOTAL;

---

**DCHK:MMIN**

Selects the lower magnitude display range and unit for the bargraph display.

**Related Commands:** DCHK:MMAX, DCHK:MMIN?

**Syntax:** DCHK:MMIN <nrf> [ NORM | TOTAL ]

**Factory Default:** 0 NORM

**Example:** DCHK:MMIN 0 TOTAL

---

**DCHK:MMIN?**

Returns the current upper magnitude range setting for the bargraph display in currently selected units.

**Related Commands:** DCHK:MMIN

**Syntax:** DCHK:MMIN?

**Example:** :DCHK:MMIN?

**Response:** MMIN 0.0 TOTAL;

---

**DCHK:SET?**

Returns the query responses for all the queries under the :DCHK: compound command header. The response is preceded by :DISP GPIB and followed by :DISPLAY *current\_display\_panel*. Equivalent to sending the following query string:

```
:DCHK:DBITS?;DUNIT?;MMAX?;MMIN?;UNIT?;:DISPLAY?
```

**Related Commands:** All DCHK: queries

**Syntax:** DCHK:SET?

**Example:** DCHK:SET?

**Response:** :DISP GPIB;:DCHK:DBITS ACTV;DUNIT HEX;MMAX 1000 NORM;MMIN 0 NORM;UNIT NORM;:DISPLAY PANEL;

---

**DCHK:UNIT**

Selects the measurement units for the data error measurements. The choices are NORM or TOTAL. If TOTAL is selected, resets the current error measurement to zero and begins the totalize mode. Resending the UNIT TOTAL command will reset the measurement to zero.

**Related Commands:** DCHK:UNIT?

**Syntax:** DCHK:UNIT [ NORM | TOTAL ]

**Factory Default:** NORM

**Example:** DCHK:UNIT TOTAL

---

**DCHK:UNIT?**

Returns the measurement units for the data error measurements.

**Related Commands:** DCHK:UNIT

**Syntax:** DCHK:UNIT?

**Example:** DCHK:UNIT?

**Response:** UNIT TOTAL;

---

## DIMD:

Compound command header for the Digital Intermodulation Distortion measurement function.

---

### DIMD:AMAX

This command sets the maximum amplitude level for an amplitude sweep of the analog generator, the digital generator, or the jitter generator.

Set the generator type and unit before sending the AMAX command. Subsequent changes to the generator type may cause the AMAX setting to be changed.

The numeric argument and its unit should be within the valid amplitude range of the generator and its waveform type. The maximum level for an amplitude sweep will be the argument value and units for the generator last selected with the GENERator command or selected by the user with the front panel OUTPUT button.

If the AMAX argument value is less than the current setting of the AMIN command but within the range of the generator, then the AMIN command setting will be coerced to a lower value and no error will be generated.

Error 4 “CONFLICT WITH MAXIMUM AMPLITUDE” will be generated if the argument is outside of the range of the generator.

See Section 1 General Information – Sweeps for more information about interactions between amplitude sweep parameters and changes of the currently selected generator.

**Related Commands:** DIMD:AMIN, DIMD:AMAX?, SWPType

**Syntax:** DIMD:AMAX <nrf> unit

**Factory Default:** 1.0 V

**Example:** DIMD:AMAX 0. DBFS

---

### DIMD:AMAX?

Returns the maximum amplitude level set by the AMAX command.

**Related Commands:** DIMD:AMAX

**Syntax:** DIMD:AMAX?

**Example:** DIMD:AMAX?

**Response:** AMAX 0. DBFS;

---

## DIMD:AMIN

This command sets the minimum amplitude level for an amplitude sweep of the analog generator, the digital generator, or the jitter generator.

Set the generator type and unit before sending the AMIN command with compatible units. Subsequent changes to the generator may cause the AMIN setting to be changed.

The numeric argument and its unit should be within the valid amplitude range of the generator and its waveform type. The minimum level for an amplitude sweep will be the argument value and units for the generator last selected with the GENERator command or selected by the user with the front panel OUTPUT button.

If the AMIN argument value is greater than the current setting of the AMAX command but within the range of the generator, then the AMAX command setting will be coerced to a higher value and no error will be generated.

Error 5 “CONFLICT WITH MINIMUM AMPLITUDE” will be generated if the argument is outside of the range of the generator.

See Section 1 General Information – Sweeps for more information about interactions between amplitude sweep parameters and changes of the currently selected generator.

**Related Commands:** DIMD:AMIN?, DIMD:AMAX, SWPType

**Syntax:** DIMD:AMIN <nrf> unit

**Factory Default:** 0.0 V

**Example:** DIMD:AMIN -140. DBFS

---

## DIMD:AMIN?

Returns the minimum amplitude level set by the AMIN command.

**Related Commands:** DIMD:AMIN

**Syntax:** AMPLitude:AMIN?

**Example:** DIMD:AMIN?

**Response:** AMIN -140. DBFS;

---

## DIMD:LUNit

Selects the level display units for the Digital DIMD measurement function.

**Related Commands:** REFDBR, DIMD:LUNit?

**Syntax:** DIMD:LUNit { FFS | DBFS | DBR }

**Factory Default:** DBFS

**Example:** DIMD:LUNIT DBFS

---

**DIMD:LUNit?**

Returns the currently selected level display units for the Digital DIMD measurement function.

**Related Commands:** DIMD:LUNit

**Syntax:** DIMD:LUNit?

**Example:** DIMD:LUNIT?

**Response:** LUNIT DBFS;

---

**DIMD:MMAX**

Selects the upper magnitude display range for the bargraph display in currently selected units. The selected units will be the displayed units only if the bargraph or sweep is being displayed when this command is received.

**Related Commands:** DIMD:MMIN, DIMD:MMAX?

**Syntax:** DIMD:MMAX <nrf> [ PCT | DB ]

**Factory Default:** -40 DB

**Example:** DIMD:MMAX 5 PCT

---

**DIMD:MMAX?**

Returns the current upper magnitude range setting for the bargraph display in currently selected units.

**Related Commands:** DIMD:MMAX

**Syntax:** DIMD:MMAX?

**Example:** DIMD:MMAX?

**Response:** MMAX 5. PCT;

---

**DIMD:MMIN**

Selects the lower magnitude display range for the bargraph display. The selected units will be the displayed units only if the bargraph or sweep is being displayed when this command is received.

**Related Commands:** DIMD:MMAX, DIMD:MMIN?

**Syntax:** DIMD:MMIN <nrf> [ PCT | DB ]

**Factory Default:** -999. DB

**Example:** DIMD:MMIN -100 DB

---

**DIMD:MMIN?**

Returns the current upper magnitude range setting for the bargraph display in currently selected units.

**Related Commands:** DIMD:MMIN

**Syntax:** DIMD:MMIN?

**Example:** DIMD:MMIN?

**Response:** MMIN -100. DB;

---

**DIMD:SET?**

Returns the query responses for all the queries under the :DIMD: compound command header. The response is preceded by :DISP GPIB and followed by :DISPLAY *current\_display\_panel*. Equivalent to sending the following query string:

```
:DIMD:AMAX?;AMIN?;LUNIT?;MMAX?;MMIN?;SPEED?;STEP
S?;UNIT?;:DISPLAY?
```

**Related Commands:** All DIMD: queries

**Syntax:** DIMD:SET?

**Example:** DIMD:SET?

**Response:** :DISP GPIB;:DIMD:AMAX 0. DBFS;AMIN -999.  
DBFS;LUNIT DBFS;MMAX -40. DB;MMIN -999. DB;SPEED  
FAST;STEPS 0;UNIT DB;:DISPLAY PANEL;

---

**DIMD:SPEEd**

Selects the sweep speed.

**Related Commands:** DIMD:SPEEd?

**Syntax:** DIMD:SPEEd { FAST | MEDium | SLOW }

**Factory Default:** FAST

**Example:** DIMD:SPEED MEDIUM

---

**DIMD:SPEEd?**

Returns the currently selected sweep speed.

**Related Commands:** DIMD:SPEEd

**Syntax:** DIMD:SPEEd?

**Example:** DIMD:SPEED?

**Response:** SPEED MEDIUM;

---

**DIMD:STEPs**

Selects the the number of sweep steps. A step value of 0 selects 2 dB steps. All other values select the internal sweep mode with the indicated number of steps calculated using the AMIN and AMAX values for amplitude sweeps.

**Related Commands:** DIMD:EXTernal, DIMD:STEP, DIMD:FMIN, DIMD:FMAX

**Syntax:** DIMD:STEP { 0 | 3 | 5 | 10 | 15 | 30 | 75 | 150 }

**Factory Default:** 0

**Example:** DIMD:STEP 3

---

**DIMD:STEPs?**

Returns the selected sweep mode or the number of sweep steps selected for the internal sweep mode.

**Related Commands:** DIMD:STEP

**Syntax:** DIMD:STEPs?

**Example:** DIMD:STEP?

**Response:** STEP 3;

---

**DIMD:UNIT**

Selects the DIMD measurement units of percent and dB.

**Related Commands:** DIMD:UNIT?

**Syntax:** DIMD:UNIT { PCT | DB }

**Factory Default:** DB

**Example:** DIMD:UNIT DB

---

**DIMD:UNIT?**

Returns the currently selected DIMD measurement units.

**Related Commands:** DIMD:UNIT

**Syntax:** DIMD:UNIT?

**Example:** DIMD:UNIT?

**Response:** UNIT DB;

---

## DIO:

Compound command header for the Digital Interface function measurement parameters. The digital interface measurements are Input Sample Rate, Input Pulse Amplitude, and Output to Input Delay (or Reference Input to Input Delay).

---

### DIO:DDREF

Selects the reference source for the Digital Delay measurement function. The reference source determines delay with reference to the digital generator output or with reference to the digital signal on the synch ref input XLR. Choices are: OUTBlock, OUTFrame, REFBlock, REFFrame.

**Related Commands:** DIO:DDREF?

**Syntax:** DIO:DDREF { OUTBlock | OUTFrame | REFBlock | REFFrame }

**Factory Default:** OUTFrame

**Example:** DIO:DDREF REFBLOCK

---

### DIO:DDREF?

Returns the currently selected reference source for the Digital Delay measurement.

**Related Commands:** DIO:DDREF

**Syntax:** DIO:DDREF?

**Example:** DIO:DDREF?

**Response:** DDREF REFBLOCK;

---

### DIO:DIResolution

Selects the number of data bits of resolution applied to both channels of the digital audio data on the digital inputs. A value of 0 selects the AutoResolution mode which sets the input resolution according to the number of bits encoded in the channel A input status byte. Fixed resolution is specified in terms of bits in even numbers from 16 to 24. Allowable arguments are 0, 16, 18, 20, 22, and 24. The numeric argument must be exact or a command error will be generated.

**Related Commands:** DIO:DIResolution?

**Syntax:** DIO:DIResolution <nr1>

**Factory Default:** 24

**Example:** :DIO:DIRESOLUTION 16

---

## DIO:DIResolution?

Returns the currently selected number of data bits of resolution applied to both channels of the digital audio data on the digital inputs. A value of 0 indicates that the AutoResolution mode is selected, which sets the input resolution according to the number of bits encoded in the channel A input status byte.

**Related Commands:** DIO:DIResolution  
**Syntax:** DIO:DIResolution?  
**Example:** :DIO:DIRESOLUTION?  
**Response:** DIRESOLUTION 16;

---

## DIO:DUNit

Selects units for the Digital Delay measurement function. Valid units are unit intervals (UI), samples (SMP), and seconds (SEC).

**Related Commands:** DIO:DUNit?  
**Syntax:** DIO:DUNit { UI | SMP | SEC }  
**Factory Default:** SEC  
**Example:** DIO:DUNIT SMP

---

## DIO:DUNit?

Returns the currently selected Digital Delay measurement function units.

**Related Commands:** DIO:DUNit  
**Syntax:** DIO:DUNit?  
**Example:** DIO:DUNIT?  
**Response:** DUNIT SMP;

---

## DIO:FRQRef

Selects digital audio frequency reference source for digital audio frequency measurement functions. The reference source may be: input measured sample rate (MEAS), input status bits sample rate (STAT), digital generator output sample rate (OUTP).

**Related Commands:** DIO:FRQRef?  
**Syntax:** DIO:FRQRef { MEAS | OUTP | STAT }  
**Factory Default:** MEAS  
**Example:** DIO:FRQREF OUTP

---

## DIO:FRQRef?

Returns the currently selected digital audio frequency reference source for digital audio frequency measurement functions.

**Related Commands:** DIO:FRQRef  
**Syntax:** DIO:FRQRef?  
**Example:** DIO:FRQREF?  
**Response:** FRQREF OUTP;

---

## DIO:MMAX

Selects the upper magnitude display range for the sample rate bargraph display. The selected units will be the displayed units only if the bargraph or sweep is being displayed when this command is received.

**Related Commands:** DIO:MMAX?, DIO:MMIN

**Syntax:** DIO:MMAX <nrf> [ HZ | PPM ]

**Factory Default:** 50000. HZ

**Example:** DIO:MMAX 53.5E+3 HZ

---

## DIO:MMAX?

Returns the current upper magnitude range setting for the sample rate bargraph display in currently selected units.

**Related Commands:** DIO:MMAX

**Syntax:** DIO:MMAX?

**Example:** DIO:MMAX?

**Response:** MMAX 5.35E+5 HZ;

---

## DIO:MMIN

Selects the lower magnitude display range for the sample rate bargraph display. The selected units will be the displayed units only if the bargraph or sweep is being displayed when this command is received.

**Related Commands:** DIO:MMAX, DIO:MMIN?

**Syntax:** DIO:MMIN <nrf> [ HZ | PPM ]

**Factory Default:** 30000. HZ

**Example:** DIO:MMIN 28.5E+3 HZ

---

## DIO:MMIN?

Returns the current lower magnitude range setting for the sample rate bargraph display in currently selected units.

**Related Commands:** DIO:MMIN

**Syntax:** DIO:MMIN?

**Example:** DIO:MMIN?

**Response:** MMIN 2.85E+4 HZ;

---

**DIO:SET?**

Returns the query responses for all the queries under the :DIO: compound command header. The response is preceded by :DISP GPIB and followed by :DISPLAY *current\_display\_panel*. Equivalent to sending the following query string:

```
:DIO:DDREF?;DIRESOLUTION?;DUNIT?;FRQREF?;MMAX?;MMIN?;UNIT?;:DISPLAY?
```

**Related Commands:** All DIO: queries

**Syntax:** DIO:SET?

**Example:** DIO:SET?

**Response:** :DISP GPIB;:DIO:DDREF OUTF;DIRESOLUTION 24.;DUNIT SEC;FRQREF MEAS;MMAX 50000. HZ;MMIN 30000. HZ;UNIT HZ;:DISPLAY PANEL;

---

**DIO:UNIT**

Selects units for the Digital Sample Rate measurement function.

**Related Commands:** DIO:UNIT?

**Syntax:** DIO:UNIT { HZ | PPM }

**Factory Default:** HZ

**Example:** DIO:UNIT PPM

---

**DIO:UNIT?**

Returns the currently selected Digital Sample Rate measurement function units.

**Related Commands:** DIO:UNIT

**Syntax:** DIO:UNIT?

**Example:** DIO:UNIT?

**Response:** UNIT PPM;

---

## DJITter:

Compound command header for the Digital Jitter function measurement parameters.

---

### DJITter:AMAX

This command sets the maximum amplitude level for an amplitude sweep of the analog generator, the digital generator, or the jitter generator when the SWPType command is set to AMPL.

Set the generator type and unit before sending the AMAX command. Subsequent changes to the generator type may cause the AMAX setting to be changed.

The numeric argument and its unit should be within the valid amplitude range of the generator and its waveform type. The maximum level for an amplitude sweep will be the argument value and units for the generator last selected with the GENERator command or selected by the user with the front panel OUTPUT button.

If the AMAX argument value is less than the current setting of the AMIN command but within the range of the generator, then the AMIN command setting will be coerced to a lower value and no error will be generated.

Error 4 “CONFLICT WITH MAXIMUM AMPLITUDE” will be generated if the argument is outside of the range of the generator.

See Section 1 General Information – Sweeps for more information about interactions between amplitude sweep parameters and changes of the currently selected generator.

**Related Commands:** DJITter:AMIN, DJITter:AMAX?, SWPType

**Syntax:** DJITter:AMAX <nrf> unit

**Factory Default:** 1.0 V

**Example:** DJITTER:AMAX 0. DBFS

---

### DJITter:AMAX?

Returns the maximum amplitude level set by the AMAX command.

**Related Commands:** DJITter:AMAX

**Syntax:** DJITter:AMAX?

**Example:** DJITTER:AMAX?

**Response:** AMAX 0. DBFS;

---

## DJITter:AMIN

This command sets the minimum amplitude level for an amplitude sweep of the analog generator, the digital generator, or the jitter generator when the SWPType command is set to AMPL.

Set the generator type and unit before sending the AMIN command with compatible units. Subsequent changes to the generator may cause the AMIN setting to be changed.

The numeric argument and its unit should be within the valid amplitude range of the generator and its waveform type. The minimum level for an amplitude sweep will be the argument value and units for the generator last selected with the GENERator command or selected by the user with the front panel OUTPUT button.

If the AMIN argument value is greater than the current setting of the AMAX command but within the range of the generator, then the AMAX command setting will be coerced to a higher value and no error will be generated.

Error 5 “CONFLICT WITH MINIMUM AMPLITUDE” will be generated if the argument is outside of the range of the generator.

See Section 1 General Information – Sweeps for more information about interactions between amplitude sweep parameters and changes of the currently selected generator.

**Related Commands:** DJITter:AMIN?, DJITter:AMAX, SWPType

**Syntax:** DJITter:AMIN <nrf> unit

**Factory Default:** 0.0 V

**Example:** AMIN -140. DBFS;

---

## DJITter:AMIN?

Returns the minimum amplitude level set by the AMIN command.

**Related Commands:** DJITter:AMIN

**Syntax:** DJITter:AMIN?

**Example:** DJITTER:AMIN?

**Response:** AMIN -140. DBFS;

---

## DJITter:BPFR

Selects the center frequency for the Digital Jitter analyzer tunable bandpass filter when the Selective filter is selected. The HZ unit is optional.

**Related Commands:** DJITter:FILTER, DJITter:BPFR?

**Syntax:** DJITter:BPFR <nrf> [ HZ ]

**Factory Default:** 1 E+3 HZ

**Example:** DJITter:BPFR 2500

---

**DJITter:BPFR?**

Returns the Digital Jitter analyzer tunable bandpass filter center frequency.

**Related Commands:** DJITter:BPFR

**Syntax:** DJITter:BPFR?

**Example:** DJITTER:BPFR?

**Response:** BPFR 2.5E+3 HZ;

---

**DJITter:EXTernal**

Selects glide or step settling in external sweep mode.

**Related Commands:** DJITter:STEP, DJITter:EXTernal?

**Syntax:** DJITter:EXTernal { GLIDe | STEP }

**Factory Default:** GLIDE

**Example:** DJITTER:EXTERNAL STEP

---

**DJITter:EXTernal?**

Returns the current external sweep settling mode.

**Related Commands:** DJITter:EXTernal

**Syntax:** DJITter:EXTernal?

**Example:** DJITTER:EXTERNAL?

**Response:** EXTERNAL STEP;

---

**DJITter:FILTer**

Selects the filter for the Digital Jitter analyzer function, identical to the front-panel selection. SElective enables the tuned bandpass filter with center frequency set by the BPFR command.

**Related Commands:** DJITter:FILTer?, DJITter BPFR

**Factory Default:** UNWTD

**Syntax:** DJITter:FILTer { SElective | UNWTD }

**Example:** DJITTER:FILTER UNWTD

---

**DJITter:FILTer?**

Returns the current filter for the Digital Jitter function.

**Related Commands:** DJITter:FILTer

**Syntax:** DJITter:FILTer?

**Example:** DJITTER:FILTER?

**Response:** FILTER UNWTD;

---

## DJITter:FMAX

Selects the upper frequency display range for the sweep display. The frequency sweep step values will be computed using this value. The HZ unit is optional.

**Related Commands:** DJITter:FMIN, DJITter:FMAX?

**Syntax:** DJITter:FMAX <nrf> [ HZ ]

**Factory Default:** 20. E+3 HZ

**Example:** DJITTER:FMAX 16K HZ

---

## DJITter:FMAX?

Returns the current upper frequency range setting for the sweep display.

**Related Commands:** DJITter:FMAX

**Syntax:** DJITter:FMAX?

**Example:** DJITTER:FMAX?

**Response:** FMAX 1.6E+3 HZ;

---

## DJITter:FMIN

Selects the lower frequency display range for the sweep display. The frequency sweep step values will be computed using this value. The HZ unit is optional.

**Related Commands:** DJITter:FMAX, DJITter:FMIN?

**Syntax:** DJITter:FMIN <nrf> [ HZ ]

**Factory Default:** 20 HZ

**Example:** DJITTER:FMIN 200 HZ

---

## DJITter:FMIN?

Returns the current lower frequency range setting for the sweep display.

**Related Commands:** DJITter:FMIN

**Syntax:** DJITter:FMIN?

**Example:** DJITTER:FMIN?

**Response:** FMIN 2.0E+2 HZ;

---

## DJITter:HPASS

Selects the jitter measurement high pass filter cut off frequency. Values of 50 Hz or 700 Hz may be selected.

**Related Commands:** DJITter:HPASSs?

**Syntax:** DJITter:HPASSs [ HP50 | HP700 ]

**Factory Default:** HP50

**Example:** DJITTER:HPASS HP700

---

**DJITter:HPASs?**

Returns the jitter measurement high pass filter cut off frequency setting.

**Related Commands:** DJITter:HPASs

**Syntax:** DJITter:HPASs?

**Example:** DJITTER:HPASS?

**Response:** HPASS HP700;

---

**DJITter:JDETECTOR**

Selects Peak or RMS jitter detector.

**Related Commands:** DJITter:JDETECTOR?

**Syntax:** DJITter:JDETECTOR { PEAK | RMS }

**Factory Default:** RMS

**Example:** DJITTER:JDETECTOR PEAK

---

**DJITter:JDETECTOR?**

Returns the current selected jitter detector, Peak or RMS.

**Related Commands:** DJITter:JDETECTOR

**Syntax:** DJITter:JDETECTOR?

**Example:** DJITTER:JDETECTOR?

**Response:** JDETECTOR PEAK;

---

**DJITter:MMAx**

Selects the upper magnitude display range for the sweep and bargraph displays in currently selected units. The selected units will be the displayed units only if the bargraph or sweep is being displayed when this command is received.

**Related Commands:** DJITter:MMAx

**Syntax:** DJITter:MMAx <nrf> [ UI | SEC ]

**Factory Default:** 1 UI

**Example:** DJITTER:MMAx 10 UI

---

**DJITter:MMAx?**

Returns the current upper magnitude range setting for the sweep and bargraph displays in currently selected units.

**Related Commands:** DJITter:MMAx

**Syntax:** DJITter:MMAx?

**Example:** DJITTER:MMAx?

**Response:** MMAx 10. UI;

---

## DJITter:MMIN

Selects the lower magnitude display range for the sweep display. The selected units will be the displayed units only if the bargraph or sweep is being displayed when this command is received.

**Related Commands:** DJITter:MMAx, DJITter:MMIN?

**Syntax:** DJITter:MMIN <nrf> [ UI | SEC ]

**Factory Default:** 0. UI

**Example:** DJITTER:MMIN 0.50 UI

---

## DJITter:MMIN?

Returns the current upper magnitude range setting for the sweep and bargraph displays in currently selected units.

**Related Commands:** DJITter:MMIN

**Syntax:** DJITter:MMIN?

**Example:** DJITTER:MMIN?

**Response:** MMIN 5.0E-1 UI;

---

## DJITter:SET?

Returns the query responses for all the queries under the :DJITTER: compound command header. The response is preceded by :DISP GPIB and followed by :DISPLAY *current\_display\_panel*. Equivalent to sending the following query string:

```
:DJITTER:AMAX?;AMIN?;BPFR?;EXTERNAL?;FILTER?;FMAX?;
;FMIN?;HPASS?;JDETECTOR?;LUNIT?;MMAx?;MMIN?;SPEED?;
;STEPS?;SWPTYPE?;UNIT?;:DISPLAY?
```

**Related Commands:** All DJITter: queries

**Syntax:** DJITter:SET?

**Example:** DJITTER:SET?

**Response:** :DISP GPIB;:DJITTER:AMAX 0. V;AMIN 1. V;  
BPFR 1.E+3 HZ;EXTERNAL GLIDE;FILTER UNWTD;FMAX  
20.E+3 HZ;FMIN 20. HZ;HPASS HP50;JDETECTOR  
RMS;LUNIT VPP;MMAx 1. UI;MMIN 0. UI;SPEED  
FAST;STEPS 0;SWPTYPE FREQ;UNIT UI;:DISPLAY  
PANEL;

---

## DJITter:SPEEd

Selects the sweep speed.

**Related Commands:** DJITter:SPEEd?

**Syntax:** DJITter:SPEEd { FAST | MEDium | SLOW }

**Factory Default:** FAST

**Example:** DJITTER:SPEED MEDIUM

---

## DJITter:SPEEd?

Returns the currently selected sweep speed.

**Related Commands:** DJITter:SPEEd

**Syntax:** DJITter:SPEEd?

**Example:** DJITTER:SPEED?

**Response:** SPEED MEDIUM;

---

## DJITter:STEPS

Selects the sweep mode or the number of sweep steps. A step value of 0 selects the 1/3 octave frequency table if a frequency sweep is desired (SWPType is FREQ) or 2 dB steps if an amplitude sweep is desired (SWPType is AMPL). A step value of -1 selects the external sweep mode if SWPType is FREQ. All other values select the internal sweep mode with the indicated number of steps calculated using the FMIN and FMAX values for frequency sweeps and using the AMIN and AMAX values for amplitude sweeps. STEPs -1 (external sweep) is not permitted if SWPType is AMPL.

**Related Commands:** DJITter:EXTernal, DJITter:FMIN, DJITter:FMAX, DJITter:STEPTEP?

**Syntax:** DJITter:STEP { -1 | 0 | 3 | 5 | 10 | 15 | 30 | 75 | 150 }

**Factory Default:** 0

**Example:** DJITTER:STEP 75

---

## DJITter:STEPS?

Returns the selected sweep mode or the number of sweep steps selected for the internal sweep mode.

**Related Commands:** DJITter:STEP

**Syntax:** DJITter:STEPTEP?

**Example:** DJITTER:STEP?

**Response:** STEP 75;

---

## DJITter:SWPType

Specifies that either a frequency sweep or amplitude sweep is to be performed when the SWEEP START command is received. Amplitude sweeps and frequency sweeps proceed from high to low (from FMAX to FMIN and from AMIN to AMAX). The type of sweep is dependent on the currently selected generator (ANALOG, DIGITAL, or JITTER) and the currently selected measurement function. The currently displayed or last-selected generator will be used. SWPType AMPL is not permitted if STEPs is -1 (external sweep).

**Related Commands:** GENerator, DGENerator, and measurement function settings STEPTEP, FMAX, FMIN, AMAX, AMIN, EXTernal

**Syntax:** DJITter:SWPType { FREQ | AMPL }

**Factory Default:** FREQ

**Example:** DJITTER:SWPTYPE AMPL

---

## DJITter:SWPType?

Returns the setting of the sweep type, indicating that either a frequency sweep or amplitude sweep is to be performed when the SWEEP START command is received.

**Related Commands:** GENerator, DGENerator, and measurement function settings STEPTEP, FMAX, FMIN, AMAX, AMIN, EXTernal

**Syntax:** DJITter:SWPType?

**Example:** DJITTER:SWPTYPE?

**Response:** DJITTER:SWPTYPE AMPL

---

## DJITter:UNIT

Selects either unit interval (UI) or seconds (SEC) units for the Digital Jitter measurement function.

**Related Commands:** DJITter:UNIT?

**Syntax:** DJITter:UNIT { UI | SEC }

**Factory Default:** UI

**Example:** DJITTER:UNIT SEC

---

## DJITter:UNIT?

Returns the currently selected Digital Jitter measurement function units, either unit interval (UI) or seconds (SEC) units for the Digital Jitter measurement function.

**Related Commands:** DJITter:UNIT

**Syntax:** DJITter:UNIT?

**Example:** DJITTER:UNIT?

**Response:** UNIT SEC;

---

## DLEVel:

Compound command header for the Digital Level measurement function.

---

### DLEVel:AMAX

This command sets the maximum amplitude level for an amplitude sweep of the analog generator, the digital generator, or the jitter generator when the SWPType command is set to AMPL.

Set the generator type and unit before sending the AMAX command. Subsequent changes to the generator type may cause the AMAX setting to be changed.

The numeric argument and its unit should be within the valid amplitude range of the generator and its waveform type. The maximum level for an amplitude sweep will be the argument value and units for the generator last selected with the GENERator command or selected by the user with the front panel OUTPUT button.

If the AMAX argument value is less than the current setting of the AMIN command but within the range of the generator, then the AMIN command setting will be coerced to a lower value and no error will be generated.

Error 4 “CONFLICT WITH MAXIMUM AMPLITUDE” will be generated if the argument is outside of the range of the generator.

See Section 1 General Information – Sweeps for more information about interactions between amplitude sweep parameters and changes of the currently selected generator.

**Related Commands:** DLEVel:AMIN, DLEVel:AMAX?, SWPType

**Syntax:** DLEVel:AMAX <nrf> unit

**Factory Default:** 1.0 V

**Example:** DLEVEL:AMAX 0. DBFS

---

### DLEVel:AMAX?

Returns the maximum amplitude level set by the AMAX command.

**Related Commands:** DLEVel:AMAX

**Syntax:** DLEVel:AMAX?

**Example:** DLEVEL:AMAX?

**Response:** AMAX 0. DBFS;

---

## DLEVel:AMIN

This command sets the minimum amplitude level for an amplitude sweep of the analog generator, the digital generator, or the jitter generator when the SWPType command is set to AMPL.

Set the generator type and unit before sending the AMIN command with compatible units. Subsequent changes to the generator may cause the AMIN setting to be changed.

The numeric argument and its unit should be within the valid amplitude range of the generator and its waveform type. The minimum level for an amplitude sweep will be the argument value and units for the generator last selected with the GENERator command or selected by the user with the front panel OUTPUT button.

If the AMIN argument value is greater than the current setting of the AMAX command but within the range of the generator, then the AMAX command setting will be coerced to a higher value and no error will be generated.

Error 5 “CONFLICT WITH MINIMUM AMPLITUDE” will be generated if the argument is outside of the range of the generator.

See Section 1 General Information – Sweeps for more information about interactions between amplitude sweep parameters and changes of the currently selected generator.

**Related Commands:** DLEVel:AMIN?, DLEVel:AMAX, SWPType, GENERator

**Syntax:** DLEVel:AMIN <nrf> unit

**Factory Default:** 0.0

**Example:** DLEVEL:AMIN -140. DBFS

---

## DLEVel:AMIN?

Returns the minimum amplitude level set by the AMIN command.

**Related Commands:** DLEVel:AMIN

**Syntax:** DLEVel:AMIN?

**Example:** DLEVEL:AMIN?

**Response:** AMIN -140. DBFS;

---

## DLEVel:EXTErnal

Selects glide or step settling in external sweep mode.

**Related Commands:** DLEVel:STEP, DLEVel:EXTErnal?

**Syntax:** DLEVel:EXTErnal { GLIDe | STEP }

**Factory Default:** GLIDE

**Example:** DLEVEL:STEP

---

**DLEVel:EXtErnal?**

Returns the current external sweep settling mode.

**Related Commands:** DLEVel:EXtErnal

**Syntax:** DLEVel:EXtErnal?

**Example:** DLEVEL:EXTERNAL?

**Response:** EXTERNAL STEP;

---

**DLEVel:FMAX**

Selects the upper frequency display range for the sweep display. The frequency sweep step values will be computed using this value. The HZ unit is optional.

**Related Commands:** DLEVel:FMIN, DLEVel:FMAX?, GAMPlitude, GFREquency, WAVEform, GENerator

**Syntax:** DLEVel:FMAX <nrf> [ HZ ]

**Factory Default:** 20000 HZ

**Example:** DLEVEL:FMAX 22E+3 HZ

---

**DLEVel:FMAX?**

Returns the current upper frequency range setting for the sweep display.

**Related Commands:** DLEVel:FMAX

**Syntax:** DLEVel:FMAX?

**Example:** DLEVEL:FMAX?

**Response:** FMAX 22.E+3 HZ;

---

**DLEVel:FMIN**

Selects the lower frequency display range for the sweep display. The frequency sweep step values will be computed using this value. The HZ unit is optional.

**Related Commands:** DLEVel:FMAX, DLEVel:FMIN?, GAMPlitude, GFREquency, WAVEform

**Syntax:** DLEVel:FMIN <nrf> [ HZ ]

**Factory Default:** 20 HZ

**Example:** DLEVEL:FMIN 100 HZ

---

**DLEVel:FMIN?**

Returns the current lower frequency range setting for the sweep display.

**Related Commands:** DLEVel:FMin

**Syntax:** DLEVel:FMIN?

**Example:** DLEVEL:FMIN?

**Response:** FMIN 100. HZ;

---

## DLEVel:LUNit

Selects the measurement units for the second channel of the level function for the level meter :M2? query response.

**Related Commands:** REFDBR

**Syntax:** DLEVel:LUNit { FFS | DBFS | DBR }

**Factory Default:** DBFS

**Example:** DLEVEL:LUNIT DBFS

---

## DLEVel:LUNit?

Returns the selected units for the second channel level measurement function.

**Related Commands:** DLEVel:LUNit

**Syntax:** DLEVel:LUNit?

**Example:** DLEVEL:LUNIT?

**Response:** LUNIT DBFS;

---

## DLEVel:MMAx

Selects the upper magnitude display range for the sweep and bargraph displays in currently selected units. The selected units will be the displayed units only if the bargraph or sweep is being displayed when this command is received.

**Related Commands:** DLEVel:MMIN, DLEVel:MMAx?

**Syntax:** DLEVel:MMAx <nrf> [ FS | DBFS | DBR ]

**Factory Default:** 0 DBFS

**Example:** DLEVEL:MMAx -5 DBFS

---

## DLEVel:MMAx?

Returns the current upper magnitude range setting for the sweep and bargraph displays in currently selected units.

**Related Commands:** DLEVel:MMAx

**Syntax:** DLEVel:MMAx?

**Example:** DLEVEL:MMAx?

**Response:** MMAx -5 DBFS;

---

## DLEVel:MMIN

Selects the lower magnitude display range for the sweep display. The selected units will be the displayed units only if the bargraph or sweep is being displayed when this command is received.

**Related Commands:** DLEVel:MMAx, DLEVel:MMAx?

**Syntax:** DLEVel:MMIN <nrf> [FS | DBFS | DBR ]

**Factory Default:** -120 DBFS

**Example:** DLEVEL:MMIN -95 DBFS

---

**DLEVel:MMIN?**

Returns the current upper magnitude range setting for the sweep and bargraph displays in currently selected units.

**Related Commands:** DLEVel:MMIN  
**Syntax:** DLEVel:MMIN?  
**Example:** DLEVEL:MMIN?  
**Response:** MMIN -9.5E+1 DBFS;

---

**DLEVel:SET?**

Returns the query responses for all the queries under the :DLEVEL: compound command header. The response is preceded by :DISP GPIB and followed by :DISPLAY *current\_display\_panel*. Equivalent to sending the following query string:

```
:DLEVEL:AMAX?;AMIN?;EXTERNAL?;FMAX?;FMIN?;LUNIT?;MMAX?;MMIN?;SPEED?;STEPS?;SWPTYPE?;UNIT?;:DISPLAY?
```

**Related Commands:** All DLEVel: queries  
**Syntax:** DLEVel:SET?  
**Example:** DLEVEL:SET?  
**Response:** :DISP GPIB;:DLEVEL:AMAX 1. V;AMIN 0. V; EXTERNAL GLIDE;FMAX 20.E+3 HZ;FMIN 20. HZ;LUNIT DBFS;MMAX 0. DBFS;MMIN -120. DBFS;SPEED FAST;STEPS 0;SWPTYPE FREQ;UNIT DBFS;:DISPLAY PANEL;

---

**DLEVel:SPEEd**

Selects the sweep speed.

**Related Commands:** DLEVel:SPEEd?  
**Syntax:** DLEVel:SPEEd { FAST | MEDium | SLOW }  
**Factory Default:** FAST  
**Example:** DLEVEL:SPEED SLOW

---

**DLEVel:SPEEd?**

Returns the currently selected sweep speed.

**Related Commands:** DLEVel:SPEEd  
**Syntax:** DLEVel:SPEEd?  
**Example:** DLEVEL:SPEED?  
**Response:** SPEED SLOW;

---

## DLEVel:STEPS

Selects the sweep mode or the number of sweep steps. A step value of 0 selects the 1/3 octave frequency table if a frequency sweep is desired (SWPType is FREQ) or 2 dB steps if an amplitude sweep is desired (SWPType is AMPL). A step value of -1 selects the external sweep mode if SWPType is FREQ. All other values select the internal sweep mode with the indicated number of steps calculated using the FMIN and FMAX values for frequency sweeps and using the AMIN and AMAX values for amplitude sweeps. STEPs -1 (external sweep) is not permitted if SWPType is AMPL.

**Related Commands:** DLEVel:EXTernal, DLEVel:FMIN, DLEVel:FMAX, DLEVel:STEPS?

**Syntax:** DLEVel:STEP { -1 | 0 | 3 | 5 | 10 | 15 | 30 | 75 }

**Factory Default:** 0

**Example:** DLEVEL:STEP 10

---

## DLEVel:STEPS?

Returns the selected sweep mode or the number of sweep steps selected for the internal sweep mode.

**Related Commands:** DLEVel STEP

**Syntax:** DLEVel:STEPS?

**Example:** DLEVEL:STEP?

**Response:** STEP 10;

---

## DLEVel:SWPType

Specifies that either a frequency sweep or amplitude sweep is to be performed when the SWEEP START command is received. Amplitude sweeps and frequency sweeps proceed from high to low (from FMAX to FMIN and from AMIN to AMAX). The type of sweep is dependent on the currently selected generator (ANALOG, DIGITAL, or JITTER) and the currently selected measurement function. The currently displayed or last-selected generator will be used. SWPType AMPL is not permitted if STEPs is -1 (external sweep).

**Related Commands:** GENerator, DGENerator, and measurement function settings STEP, FMAX, FMIN, AMAX, AMIN, EXTernal

**Syntax:** DLEVel:SWPType { FREQ | AMPL }

**Factory Default:** FREQ

**Example:** DLEVel:SWPTYPE AMPL

---

## DLEVel:SWPType?

Returns the setting of the sweep type, indicating that either a frequency sweep or amplitude sweep is to be performed when the SWEEP START command is received.

**Related Commands:** GENerator, DGENerator, and measurement function settings STEP, FMAX, FMIN, AMAX, AMIN, EXTernal

**Syntax:** DLEVel:SWPType?

**Example:** DLEVel:SWPTYPE?

**Response:** DLEVel:SWPTYPE AMPL

---

## DLEVel:UNIT

Selects the measurement units for the first channel of the level function for the function meter :M1? query response.

**Related Commands:** REFDBR, DLEVel:UNIT?

**Syntax:** DLEVel:UNIT { FFS | DBFS | DBR }

**Factory Default:** DBFS

**Example:** DLEVEL:UNIT DBFS

---

## DLEVel:UNIT?

Returns the selected units for the first channel of the level measurement function.

**Related Commands:** DLEVel:UNIT

**Syntax:** DLEVel:UNIT?

**Example:** DLEVEL:UNIT?

**Response:** UNIT DBFS;

---

## DNOise:

Compound command header for the Digital Noise measurement function.

---

### DNOise:AMAX

This command sets the maximum amplitude level for an amplitude sweep of the analog generator, the digital generator, or the jitter generator when the SWPType command is set to AMPL.

Set the generator type and unit before sending the AMAX command. Subsequent changes to the generator type may cause the AMAX setting to be changed.

The numeric argument and its unit should be within the valid amplitude range of the generator and its waveform type. The maximum level for an amplitude sweep will be the argument value and units for the generator last selected with the GENERator command or selected by the user with the front panel OUTPUT button.

If the AMAX argument value is less than the current setting of the AMIN command but within the range of the generator, then the AMIN command setting will be coerced to a lower value and no error will be generated.

Error 4 “CONFLICT WITH MAXIMUM AMPLITUDE” will be generated if the argument is outside of the range of the generator.

See Section 1 General Information – Sweeps for more information about interactions between amplitude sweep parameters and changes of the currently selected generator.

**Related Commands:** DNOise:AMIN, DNOise:AMAX?, SWPType

**Syntax:** DNOise:AMAX <nrf> unit

**Factory Default:** 1.0 V

**Example:** DNOISE:AMAX 0. DBFS

---

### DNOise:AMAX?

Returns the maximum amplitude level set by the AMAX command.

**Related Commands:** DNOise:AMAX

**Syntax:** DNOise:AMAX?

**Example:** DNOISE:AMAX?

**Response:** AMAX 0. DBFS;

---

### DNOise:AMIN

This command sets the minimum amplitude level for an amplitude sweep of the analog generator, the digital generator, or the jitter generator when the SWPType command is set to AMPL.

Set the generator type and unit before sending the AMIN command with compatible units. Subsequent changes to the generator may cause the AMIN setting to be changed.

The numeric argument and its unit should be within the valid amplitude range of the generator and its waveform type. The

minimum level for an amplitude sweep will be the argument value and units for the generator last selected with the GENERator command or selected by the user with the front panel OUTPUT button.

If the AMIN argument value is greater than the current setting of the AMAX command but within the range of the generator, then the AMAX command setting will be coerced to a higher value and no error will be generated.

Error 5 “CONFLICT WITH MINIMUM AMPLITUDE” will be generated if the argument is outside of the range of the generator.

See Section 1 General Information – Sweeps for more information about interactions between amplitude sweep parameters and changes of the currently selected generator.

**Related Commands:** DNOise:AMIN?, DNOise:AMAX, SWPTtype  
**Syntax:** DNOise:AMIN <nrf> unit  
**Factory Default:** 0. V  
**Example:** DNOISE:AMIN -140. DBFS

---

## DNOise:AMIN?

Returns the minimum amplitude level set by the AMIN command.

**Related Commands:** DNOise:AMIN  
**Syntax:** DNOise:AMIN?  
**Example:** DNOISE:AMIN?  
**Response:** AMIN -140. DBFS;

---

## DNOise:BPFR

Selects the center frequency for the tunable bandpass filter when the Selective filter is selected. The HZ unit is optional.

**Related Commands:** DNOise:FILTer, DNOise:BPFR?  
**Syntax:** DNOISE:BPFR <nrf> [ HZ ]  
**Factory Default:** 1. E+3 HZ  
**Example:** DNOISE:BPFR 2500 HZ

---

## DNOise:BPFR?

Returns the tunable bandpass filter center frequency.

**Related Commands:** DNOise:BPFR  
**Syntax:** DNOise:BPFR?  
**Example:** DNOISE:BPFR?  
**Response:** BPFR 2500.HZ;

---

## DNOise:EXtErnal

Selects glide or step settling in external sweep mode.

**Related Commands:** DNOise:STEP, DNOise:EXtErnal?

**Syntax:** DNOise:EXtErnal { GLIDe | STEP }

**Factory Default:** GLIDE

**Example:** DNOISE:EXTERNAL STEP

---

## DNOise:EXtErnal?

Returns the current external sweep settling mode.

**Related Commands:** DNOise:EXtErnal

**Syntax:** DNOise:EXtErnal?

**Example:** DNOISE:EXTERNAL?

**Response:** EXTERNAL STEP;

---

## DNOise:FILTer

Selects the filter for the Digital Noise function, identical to the front-panel selection.

**Related Commands:** DNOise:BPFR, DNOise:WTD, DNOise:FILTer?, DNOise:HPASs, DNOise:LPASs

**Syntax:** DNOise:FILTer { SElective | WTD | UNWTD }

**Factory Default:** UNWTD

**Example:** DNOISE:FILTER SELECTIVE

---

## DNOise:FILTer?

Returns the current filter for the Noise function.

**Related Commands:** DNOise:FILTer

**Syntax:** DNOise:FILTer?

**Example:** DNOISE:FILTER?

**Response:** FILTER SELECTIVE;

---

## DNOise:FMAX

Selects the upper frequency display range for the sweep display. The frequency sweep step values will be computed using this value. The HZ unit is optional.

**Related Commands:** DNOise:FMIN, DNOise:FMAX?

**Syntax:** DNOise:FMAX <nrf> [ HZ ]

**Factory Default:** 20. E+3 HZ

**Example:** DNOISE:FMAX 22000

---

**DNOise:FMAX?**

Returns the current upper frequency range setting for the sweep display.

**Related Commands:** DNOise:FMAX  
**Syntax:** DNOise:FMAX?  
**Example:** DNOISE:FMAX?  
**Response:** FMAX 2.2E+4 HZ;

---

**DNOise:FMIN**

Selects the lower frequency display range for the sweep display. The frequency sweep step values will be computed using this value. The HZ unit is optional.

**Related Commands:** DNOise:FMAX, DNOise:FMIN?, GAMplitude, GFREquency, WAVEform  
**Syntax:** DNOise:FMIN <nrf> [ HZ ]  
**Factory Default:** 20. HZ  
**Example:** DNOISE:FMIN 100

---

**DNOise:FMIN?**

Returns the current lower frequency range setting for the sweep display.

**Related Commands:** DNOise:FMIN  
**Syntax:** DNOise:FMIN?  
**Example:** DNOISE:FMIN?  
**Response:** FMIN 100. HZ;

---

**DNOise:HPASS**

Selects the high pass filter cut off frequency. Values of 10 Hz, 22 Hz, or 400 Hz may be selected. The filter cut off frequencies are valid only for the standard sampling rates of 32 KHz, 44.1 KHz, 48 KHz, 88.2 KHz, and 96 KHz.

**Related Commands:** DNOise:FILTer, DNOise:LPASs, DNOise:HPASs?  
**Syntax:** DNOise:HPASs [ HP10 | HP22 | HP400 ]  
**Factory Default:** HP10  
**Example:** DNOISE:HPASS HP22

---

**DNOise:HPASS?**

Returns the high pass filter cut off frequency setting.

**Related Commands:** DNOise:HPASs  
**Syntax:** DNOise:HPASs?  
**Example:** DNOISE:HPASS?  
**Response:** HPASS HP22;

---

## DNOise:LPASs

Selects the band pass filter cut off frequency and detector when the unweighted filter is selected. Selections are: 15 kHz RMS (R15k), 20 kHz RMS (R20k), Half Sample Rate (HALFrate), 22 kHz RMS (R22k), 22 kHz QPEAK (Q22k). The filter cut off frequencies are valid only for the standard sampling rates of 32 KHz, 44.1 KHz, 48 KHz, 88.2 KHz, and 96 KHz.

**Related Commands:** DNOise:FILTER, DNOise:HPASs, DNOise:LPASs?

**Syntax:** DNOise:LPASs { R15k | R20k | HALFrate | R22k | Q22k }

**Factory Default:** HALF RATE

**Example:** DNOISE:LPASS HALFRATE

---

## DNOise:LPASs?

Returns the current low pass filter setting and detector selection to be used when the UNWTD filter is selected.

**Related Commands:** DNOise:LPASs

**Syntax:** DNOise:LPASs?

**Example:** DNOISE:LPASS?

**Response:** LPASS HALFRATE;

---

## DNOise:MMAx

Selects the upper magnitude display range for the sweep and bargraph displays in currently selected units. The selected units will be the displayed units only if the bargraph or sweep is being displayed when this command is received.

**Related Commands:** DNOise:MMIN, DNOise:MMAx?

**Syntax:** DNOise:MMAx <nrf> [ FFS | DBFS | DBR ]

**Factory Default:** 0. DB

**Example:** DNOISE:MMAx -90 DBFS

---

## DNOise:MMAx?

Returns the current upper magnitude range setting for the sweep and bargraph displays in currently selected units.

**Related Commands:** DNOise:MMAx

**Syntax:** DNOise:MMAx?

**Example:** DNOISE:MMAx?

**Response:** MMAx -90 DBFS;

---

**DNOise:MMIN**

Selects the lower magnitude display range for the sweep display. The selected units will be the displayed units only if the bargraph or sweep is being displayed when this command is received.

**Related Commands:** DNOise:MMAx, DNOise:MMIN?

**Syntax:** DNOise:MMIN <nrf> [ FFS | DBFS | DBR ]

**Factory Default:** -120l. DBFS

**Example:** DNOISE:MMIN -140 DBFS

---

**DNOise:MMIN?**

Returns the current upper magnitude range setting for the sweep and bargraph displays in currently selected units.

**Related Commands:** DNOise:MMAx, DNOise:MMIN?

**Syntax:** DNOise:MMIN?

**Example:** DNOISE:MMIN?

**Response:** MMIN -140. DBFS;

---

**DNOise:SET?**

Returns the query responses for all the queries under the :DNOISE: compound command header. The response is preceded by :DISP GPIB and followed by :DISPLAY *current\_display\_panel*. Equivalent to sending the following query string:

```
:DNOISE:AMAX?;AMIN?;BPFR?;EXTERNAL?;FILTER?;FMAX
?;FMIN?;HPASS?;LPASS?;MMAx?;MMIN?;SPEED?;STEPS?;
SWPTYPE?;UNIT?;WTD?;:DISPLAY?
```

**Related Commands:** All DNOise: queries

**Syntax:** DNOise:SET?

**Example:** DNOISE:SET?

**Response:** :DISP GPIB;:DNOISE:AMAX 1. V;AMIN 0. V;BPFR  
1.E+3 HZ;EXTERNAL GLIDE;FILTER UNWTD;FMAX 20.E+3  
HZ;FMIN 20. HZ;HPASS HP10;LPASS HALFRATE;MMAx 0.  
DBFS;MMIN -120. DBFS;SPEED FAST;STEPS 0;SWPTYPE  
FREQ;UNIT DBFS;WTD IECA;:DISPLAY PANEL;

---

**DNOise:SPEEd**

Selects the sweep speed.

**Related Commands:** DNOise:SPEEd

**Syntax:** DNOise:SPEEd { FAST | MEDium | SLOW }

**Factory Default:** FAST

**Example:** DNOISE:SPEED MEDIUM

---

## DNOise:SPEEd?

Returns the currently selected sweep speed.

**Related Commands:** DNOise:SPEEd  
**Syntax:** DNOise:SPEEd?  
**Example:** DNOISE : SPEED?  
**Response:** SPEED MEDIUM

---

## DNOise:STEPS

Selects the sweep mode or the number of sweep steps. A step value of 0 selects the 1/3 octave frequency table if a frequency sweep is desired (SWPType is FREQ) or 2 dB steps if an amplitude sweep is desired (SWPType is AMPL). A step value of -1 selects the external sweep mode if SWPType is FREQ. All other values select the internal sweep mode with the indicated number of steps calculated using the FMIN and FMAX values for frequency sweeps and using the AMIN and AMAX values for amplitude sweeps. STEPs -1 (external sweep) is not permitted if SWPType is AMPL.

**Related Commands:** DNOise:EXternal, DNOise:STEP, DNOise:FMIN, DNOise:FMAX  
**Syntax:** DNOise:STEP { -1 | 0 | 3 | 5 | 10 | 15 | 30 | 75 | 150 }  
**Factory Default:** 0  
**Example:** DNOISE : STEP 30

---

## DNOise:STEPS?

Returns the selected sweep mode or the number of sweep steps selected for the internal sweep mode.

**Related Commands:** DNOise:STEP  
**Syntax:** DNOise:STEPS?  
**Example:** DNOISE : STEP?  
**Response:** STEP 30;

---

## DNOise:SWPType

Specifies that either a frequency sweep or amplitude sweep is to be performed when the SWEEP START command is received. Amplitude sweeps and frequency sweeps proceed from high to low (from FMAX to FMIN and from AMIN to AMAX). The type of sweep is dependent on the currently selected generator (ANALOG, DIGITAL, or JITTER) and the currently selected measurement function. The currently displayed or last-selected generator will be used. SWPType AMPL is not permitted if STEPs is -1 (external sweep).

**Related Commands:** GENerator, DGENerator, and measurement function settings STEP, FMAX, FMIN, AMAX, AMIN, EXternal  
**Syntax:** DNOise:SWPType { FREQ | AMPL }  
**Factory Default:** FREQ  
**Example:** DNOise:SWPTYPE AMPL

---

## DNOise:SWPType?

Returns the setting of the sweep type, indicating that either a frequency sweep or amplitude sweep is to be performed when the SWEEP START command is received.

**Related Commands:** GENerator, DGENerator, and measurement function settings STEP, FMAX, FMIN, AMAX, AMIN, EXTernal

**Syntax:** DNOise:SWPType?

**Example:** DNOise:SWPTYPE?

**Response:** SWPTYPE AMPL

---

## DNOise:UNIT

Selects the measurement units for the Digital Noise function.

**Related Commands:** REFDBR, DNOise:UNIT?

**Syntax:** DNOise:UNIT { FFS | DBFS | DBR }

**Factory Default:** DBFS

**Example:** DNOISE:UNIT DBFS

---

## DNOise:UNIT?

Returns the current units for the Digital Noise function.

**Related Commands:** DNOise:UNIT

**Syntax:** DNOise:UNIT?

**Example:** DNOISE:UNIT?

**Response:** UNIT DBFS;

---

## DNOise:WTD

Selects the weighting filter for the Digital Noise function when the WTD filter is selected. The choices are the same ones available from the front panel.

**Related Commands:** DNOise:FILTer, DNOise:WTD

**Syntax:** DNOise:WTD { IECa | RMSCcir | CCIR2K | QPKCcir }

**Factory Default:** IECA

**Example:** DNOISE:WTD CCIR2K

---

## DNOise:WTD?

Returns the currently selected weighting filter for the Digital Noise function.

**Related Commands:** DNOISE WTD

**Syntax:** DNOise:WTD?

**Example:** DNOISE:WTD?

**Response:** WTD CCIR2K;

---

## DPHase:

Compound command header for the Digital Phase measurement function.

---

### DPHase:AMAX

This command sets the maximum amplitude level for an amplitude sweep of the analog generator, the digital generator, or the jitter generator when the SWPType command is set to AMPL.

Set the generator type and unit before sending the AMAX command. Subsequent changes to the generator type may cause the AMAX setting to be changed.

The numeric argument and its unit should be within the valid amplitude range of the generator and its waveform type. The maximum level for an amplitude sweep will be the argument value and units for the generator last selected with the GENERator command or selected by the user with the front panel OUTPUT button.

If the AMAX argument value is less than the current setting of the AMIN command but within the range of the generator, then the AMIN command setting will be coerced to a lower value and no error will be generated.

Error 4 “CONFLICT WITH MAXIMUM AMPLITUDE” will be generated if the argument is outside of the range of the generator.

See Section 1 General Information – Sweeps for more information about interactions between amplitude sweep parameters and changes of the currently selected generator.

**Related Commands:** DPHase:AMIN, DPHase:AMAX?, SWPType

**Syntax:** DPHase:AMAX <nrf> unit

**Factory Default:** 1.0 V

**Example:** DPHASE:AMAX 0. DBFS

---

### DPHase:AMAX?

Returns the maximum amplitude level set by the AMAX command.

**Related Commands:** DPHase:AMAX

**Syntax:** DPHase:AMAX?

**Example:** DPHASE:AMAX?

**Response:** AMAX 0. DBFS;

---

## DPHase:AMIN

This command sets the minimum amplitude level for an amplitude sweep of the analog generator, the digital generator, or the jitter generator when the SWPType command is set to AMPL.

Set the generator type and unit before sending the AMIN command with compatible units. Subsequent changes to the generator may cause the AMIN setting to be changed.

The numeric argument and its unit should be within the valid amplitude range of the generator and its waveform type. The minimum level for an amplitude sweep will be the argument value and units for the generator last selected with the GENERator command or selected by the user with the front panel OUTPUT button.

If the AMIN argument value is greater than the current setting of the AMAX command but within the range of the generator, then the AMAX command setting will be coerced to a higher value and no error will be generated.

Error 5 “CONFLICT WITH MINIMUM AMPLITUDE” will be generated if the argument is outside of the range of the generator.

See Section 1 General Information – Sweeps for more information about interactions between amplitude sweep parameters and changes of the currently selected generator.

**Related Commands:** DPHase:AMIN?, DPHase:AMAX, SWPType

**Syntax:** DPHase:AMIN <nrf> unit

**Factory Default:** 0.0 V

**Example:** DPHASE:AMIN -140. DBFS

---

## DPHase:AMIN?

Returns the minimum amplitude level set by the AMIN command.

**Related Commands:** DPHase:AMIN

**Syntax:** DPHase:AMIN?

**Example:** DPHASE:AMIN?

**Response:** AMIN -140. DBFS;

---

## DPHase:EXtErnal

Selects glide or step settling in external sweep mode.

**Related Commands:** DPHase:STEP, DPHase:EXtErnal?

**Syntax:** DPHase:EXtErnal { GLIDe | STEP }

**Factory Default:** GLIDE

**Example:** DPHASE:EXTERNAL STEP

---

## DPHase:EXtErnal?

Returns the current external sweep settling mode.

**Related Commands:** DPHase:EXtErnal

**Syntax:** DPHase:EXtErnal?

**Example:** DPHASE:EXTERNAL?

**Response:** EXTERNAL STEP;

---

## DPHase:FMAX

Selects the upper frequency display range for the sweep display. The frequency sweep step values will be computed using this value.

**Related Commands:** DPHase:FMIN, DPHase:FMAX?, GAMPlitude, GFREquency, WAVeform

**Syntax:** DPHase:FMAX <nrf> [ HZ | KHZ ]

**Factory Default:** 20. E+3 HZ

**Example:** DPHASE:FMAX 16 KHZ

---

## DPHase:FMAX?

Returns the current upper frequency range setting for the sweep display.

**Related Commands:** DPHase:FMAX

**Syntax:** DPHase:FMAX?

**Example:** DPHASE:FMAX?

**Response:** FMAX 1.6E+4 HZ;

---

## DPHase:FMIN

Selects the lower frequency display range for the sweep display. The frequency sweep step values will be computed using this value.

**Related Commands:** DPHase:FMAX, DPHase:FMIN?, GAMPlitude, GFREquency, WAVeform

**Syntax:** DPHase:FMIN <nrf> [ HZ | KHZ ]

**Factory Default:** 20. HZ

**Example:** DPHASE:FMIN 2.0E+2 HZ

---

## DPHase:FMIN?

Returns the current lower frequency range setting for the sweep display.

**Related Commands:** DPHase:FMIN

**Syntax:** DPHase:FMIN?

**Example:** DPHASE:FMIN?

**Response:** FMIN 200. HZ;

---

## DPHase:LUNit

Selects the Digital Level meter units for the center meter.

**Related Commands:** DPHase:LUNit:, DREFDBR

**Syntax:** DPHase:LUNit { FFS | DBFS | DBR }

**Factory Default:** DBFS

**Example:** DPHASE:LUNIT DBFS

---

## DPHase:LUNit?

Returns the currently selected Digital Level meter units for the center meter.

**Related Commands:** DPHase:LUNit

**Syntax:** DPHase:LUNit?

**Example:** DPHASE:LUNIT?

**Response:** LUNIT DBFS;

---

## DPHase:MMAX

Selects the upper magnitude display range for the sweep display.

**Related Commands:** DPHase:MMIN, DPHase:MMAX?

**Syntax:** DPHase:MMAX <nrf> [ DEG ]

**Factory Default:** 180 DEG

**Example:** DPHASE:MMAX 170 DEG

---

## DPHase:MMAX?

Returns the current upper magnitude range setting for the sweep and bargraph displays in currently selected units.

**Related Commands:** DPHase:MMAX

**Syntax:** DPHase:MMAX <nrf> [ DEG ]

**Example:** DPHASE:MMAX?

**Response:** MMAX 170. DEG;

---

## DPHase:MMIN

Selects the lower magnitude display range for the sweep display.

**Related Commands:** DPHase:MMAX, DPHase:MMIN?

**Syntax:** DPHase:MMIN <nrf> [ DEG ]

**Factory Default:** -180 DEG

**Example:** DPHASE:MMIN 100

---

**DPHase:MMIN?**

Returns the current upper magnitude range setting for the sweep and bargraph displays in currently selected units.

**Related Commands:** DPHase:MMIN  
**Syntax:** DPHase:MMIN?  
**Example:** DPHASE:MMIN?  
**Response:** MMIN 100. DEG;

---

**DPHase:RANGE**

Selects the Digital Phase meter display range. DEG90 specifies the -270/+90 range. DEG180 specifies the -180/+180 range. DEG270 specifies the -90/+270 range.

**Related Commands:** DPHase:RANGe?  
**Syntax:** DPHase:RANGe { DEG90 | DEG180 | DEG270 }  
**Factory Default:** DEG270  
**Example:** :DPHASE:RANGE DEG90

---

**DPHase:RANGe?**

Returns the Digital Phase meter display range.

**Related Commands:** DPHase:RANGe  
**Syntax:** DPHase:RANGe?  
**Example:** DPHASE:RANGE?  
**Response:** RANGE DEG90;

---

**DPHase:SET?**

Returns the query responses for all the queries under the :DPHASE: compound command header. The response is preceded by :DISP GPIB and followed by :DISPLAY *current\_display\_panel*. Equivalent to sending the following query string:

```
:DPHASE:AMAX?;AMIN?;EXTERNAL?;FMAX?;FMIN?;LUNIT?;MMAX?;MMIN?;RANGE?;SPEED?;STEPS?;SWPTYPE?;UNIT?;:DISPLAY?
```

**Related Commands:** All DPHase: queries  
**Syntax:** DPHase:SET?  
**Example:** DPHASE:SET?  
**Response:** :DISP GPIB;:DPHASE:AMAX 1. V;AMIN 0. V;EXTERNAL GLIDE;FMAX 20.E+3 HZ;FMIN 20. HZ;LUNIT DBFS;MMAX 180. DEG;MMIN -180. DEG;RANGE DEG270;SPEED FAST;STEPS 0;SWPTYPE FREQ;UNIT DEG;:DISPLAY PANEL;

---

## DPHase:SPEEd

Selects the sweep speed.

**Related Commands:** DPHase:SPEEd?

**Syntax:** DPHase:SPEEd { FAST | MEDium | SLOW }

**Factory Default:** FAST

**Example:** DPHASE : SPEED MEDIUM

---

## DPHase:SPEEd

Returns the currently selected sweep speed.

**Related Commands:** DPHase:SPEEd

**Syntax:** DPHase:SPEEd?

**Example:** DPHASE : SPEED?

**Response:** SPEED MEDIUM;

---

## DPHase:STEPs

Selects the sweep mode or the number of sweep steps. A step value of 0 selects the 1/3 octave frequency table if a frequency sweep is desired (SWPType is FREQ) or 2 dB steps if an amplitude sweep is desired (SWPType is AMPL). A step value of -1 selects the external sweep mode if SWPType is FREQ. All other values select the internal sweep mode with the indicated number of steps calculated using the FMIN and FMAX values for frequency sweeps and using the AMIN and AMAX values for amplitude sweeps. STEPs -1 (external sweep) is not permitted if SWPType is AMPL.

**Related Commands:** DPHase:EXTernal, DPHase:FMIN, DPHase:FMAX, DPHase:STEP

**Syntax:** DPHase:STEP { -1 | 0 | 3 | 5 | 10 | 15 | 30 | 75 | 150 }

**Factory Default:** 0

**Example:** DPHASE : STEP 30

---

## DPHase:STEPs?

Returns the selected sweep mode or the number of sweep steps selected for the internal sweep mode.

**Related Commands:** DPHase:STEP

**Syntax:** DPHase:STEPs?

**Example:** DPHASE : STEP?

**Response:** STEP 30;

---

## DPHase:SWPType

Specifies that either a frequency sweep or amplitude sweep is to be performed when the SWEEP START command is received. Amplitude sweeps and frequency sweeps proceed from high to low (from FMAX to FMIN and from AMIN to AMAX). The type of sweep is dependent on the currently selected generator (ANALOG, DIGITAL, or JITTER) and the currently selected measurement function. The currently displayed or last-selected generator will be used. SWPType AMPL is not permitted if STEPs is -1 (external sweep).

**Related Commands:** GENerator, DGENerator, and measurement function settings STEP, FMAX, FMIN, AMAX, AMIN, EXTernal

**Syntax:** DPHase:SWPType { FREQ | AMPL }

**Factory Default:** FREQ

**Example:** SWPType AMPL

---

## DPHase:SWPType?

Returns the setting of the sweep type, indicating that either a frequency sweep or amplitude sweep is to be performed when the SWEEP START command is received.

**Related Commands:** GENerator, DGENerator, and measurement function settings STEP, FMAX, FMIN, AMAX, AMIN, EXTernal

**Syntax:** DPHase:SWPType?

**Example:** DPHASE:SWPType?

**Response:** DPHASE:SWPType AMPL

---

## DPHase:UNIT

Selects the default degree measurement units for the DPHASE function. This command is included only for the sake of consistency and is not needed to specify degree units.

**Related Commands:** DPHase:UNIT?

**Syntax:** DPHase:UNIT DEG

**Factory Default:** DEG

**Example:** DPHASE:UNIT DEG

---

## DPHase:UNIT?

Returns the degree units setting for the DPHASE function.

**Related Commands:** DPHase:UNIT

**Syntax:** DPHase:UNIT?

**Example:** DPHASE:UNIT?

**Response:** UNIT DEG;

---

## DRATio:

Compound command header for the Digital Ratio measurement function.

---

### DRATio:AMAX

This command sets the maximum amplitude level for an amplitude sweep of the analog generator, the digital generator, or the jitter generator when the SWPType command is set to AMPL.

Set the generator type and unit before sending the AMAX command. Subsequent changes to the generator type may cause the AMAX setting to be changed.

The numeric argument and its unit should be within the valid amplitude range of the generator and its waveform type. The maximum level for an amplitude sweep will be the argument value and units for the generator last selected with the GENERator command or selected by the user with the front panel OUTPUT button.

If the AMAX argument value is less than the current setting of the AMIN command but within the range of the generator, then the AMIN command setting will be coerced to a lower value and no error will be generated.

Error 4 “CONFLICT WITH MAXIMUM AMPLITUDE” will be generated if the argument is outside of the range of the generator.

See Section 1 General Information – Sweeps for more information about interactions between amplitude sweep parameters and changes of the currently selected generator.

**Related Commands:** DRATio:AMIN, DRATio:AMAX?, SWPType

**Syntax:** DRATio:AMAX <nrf> unit

**Factory Default:** 1.0 V

**Example:** DRATIO:AMAX 0. DBFS

---

### DRATio:AMAX?

Returns the maximum amplitude level set by the AMAX command.

**Related Commands:** DRATio:AMAX

**Syntax:** DRATio:AMAX?

**Example:** DRATIO:AMAX?

**Response:** AMAX 0. DBFS;

---

### DRATio:AMIN

This command sets the minimum amplitude level for an amplitude sweep of the analog generator, the digital generator, or the jitter generator when the SWPType command is set to AMPL.

Set the generator type and unit before sending the AMIN command with compatible units. Subsequent changes to the generator may cause the AMIN setting to be changed.

The numeric argument and its unit should be within the valid amplitude range of the generator and its waveform type. The

minimum level for an amplitude sweep will be the argument value and units for the generator last selected with the GENERator command or selected by the user with the front panel OUTPUT button.

If the AMIN argument value is greater than the current setting of the AMAX command but within the range of the generator, then the AMAX command setting will be coerced to a higher value and no error will be generated.

Error 5 “CONFLICT WITH MINIMUM AMPLITUDE” will be generated if the argument is outside of the range of the generator.

See Section 1 General Information – Sweeps for more information about interactions between amplitude sweep parameters and changes of the currently selected generator.

**Related Commands:** DRATio:AMIN?, DRATio:AMAX, SWPType  
**Syntax:** DRATio:AMIN <nrf> unit  
**Factory Default:** 0.0 V  
**Example:** DRATIO:AMIN -140. DBFS

---

## DRATio:AMIN?

Returns the minimum amplitude level set by the AMIN command.

**Related Commands:** DRATio:AMIN  
**Syntax:** DRATio:AMIN?  
**Example:** DRATIO:AMIN?  
**Response:** AMIN -140. DBFS;

---

## DRATio:EXTErnal

Selects glide or step settling in external sweep mode.

**Related Commands:** DRATio:STEP, DRATio:EXTErnal?  
**Syntax:** DRATio:EXTErnal { GLIDE | STEP }  
**Factory Default:** GLIDE  
**Example:** DRATIO:EXTERNAL STEP

---

## DRATio:EXTErnal?

Returns the current external sweep settling mode.

**Related Commands:** DRATio:EXTErnal  
**Syntax:** DRATio:EXTErnal?  
**Example:** DRATIO:EXTERNAL?  
**Response:** EXTERNAL STEP;

---

**DRATio:FMAX**

Selects the upper frequency display range for the sweep display. The frequency sweep step values will be computed using this value.

**Related Commands:** DRATio:FMIN, DRATio:FMAX?, DGAMplitude, DGFRequency, DWAVeform

**Syntax:** DRATio:FMAX <nrf> [ HZ ]

**Factory Default:** 20. E+3 HZ

**Example:** DRATIO:FMAX 16 KHZ

---

**DRATio:FMAX?**

Returns the current upper frequency range setting for the sweep display.

**Related Commands:** DRATio:FMAX

**Syntax:** DRATio:FMAX?

**Example:** DRATIO:FMAX?

**Response:** FMAX 1.6E+4 HZ;

---

**DRATio:FMIN**

Selects the lower frequency display range for the sweep display. The frequency sweep step values will be computed using this value.

**Related Commands:** DRATio:FMAX, DRATio:FMIN?, DGAMplitude, DGFRequency, DWAVeform

**Syntax:** DRATio:FMIN <nrf> [ HZ | KHZ ]

**Factory Default:** 20 HZ

**Example:** DRATIO:FMIN 200 HZ

---

**DRATio:FMIN?**

Returns the current lower frequency range setting for the sweep display.

**Related Commands:** DRATio:FMIN

**Syntax:** DRATio:FMIN?

**Example:** DRATIO:FMIN?

**Response:** FMIN 2.0E+2 HZ;

---

**DRATio:LUNit**

Selects the Digital Ratio function Digital Level measurement units. OFF turns the level measurement display off.

**Related Commands:** DRATio:LUNit?, DREFdbr

**Syntax:** DRATio:LUNit { FFS | DBFS | DBR }

**Factory Default:** DBFS

**Example:** DRATIO:LUNIT DBFS

---

**DRATio:LUNit?**

Returns the currently selected Digital Ratio function Digital Level measurement units.

**Related Commands:** DRATio:LUNit

**Syntax:** DRATio:LUNit?

**Example:** DRATIO:LUNIT?

**Response:** LUNIT DBFS;

---

**DRATio:MMAx**

Selects the upper magnitude display range for the sweep and bargraph displays in currently selected units. The selected units will be the displayed units only if the bargraph or sweep is being displayed when this command is received.

**Related Commands:** DRATio:MMAx

**Syntax:** DRATio:MMAx <nrf> [ X/Y | DB ]

**Factory Default:** 20 DB

**Example:** DRATIO:MMAx 0 DB

---

**DRATio:MMAx?**

Returns the current upper magnitude range setting for the sweep and bargraph displays in currently selected units.

**Related Commands:** DRATio:MMAx

**Syntax:** DRATio:MMAx?

**Example:** DRATIO:MMAx?

**Response:** MMAx 10. X/Y;

---

**DRATio:MMIN**

Selects the lower magnitude display range for the sweep display. The selected units will be the displayed units only if the bargraph or sweep is being displayed when this command is received.

**Related Commands:** DRATio:MMAx, DRATio:MMIN?

**Syntax:** DRATio:MMIN <nrf> [ X/Y | DB ]

**Factory Default:** -60 DB

**Example:** DRATIO:MMIN 0.50 X/Y

---

**DRATio:MMIN?**

Returns the current upper magnitude range setting for the sweep and bargraph displays in currently selected units.

**Related Commands:** DRATio:MMIN

**Syntax:** DRATio:MMIN?

**Example:** DRATIO:MMIN?

**Response:** MMIN 5.0E-1 X/Y;

---

## DRATio:SET?

Returns the query responses for all the queries under the :DRATIO: compound command header. The response is preceded by :DISP GPIB and followed by :DISPLAY *current\_display\_panel*. Equivalent to sending the following query string:

```
:DRATIO:AMAX?;AMIN?;EXTERNAL?;FMAX?;FMIN?;LUNIT?;MMAX?;MMIN?;SPEED?;STEPS?;SWPTYPE?;UNIT?;:DISPLAY?
```

**Related Commands:** All DRATIO: queries

**Syntax:** DRATIO:SET?

**Example:** DRATIO:SET?

**Response:** :DISP GPIB;:DRATIO:AMAX 1. V;AMIN 0. V;EXTERNAL GLIDE;FMAX 20.E+3 HZ;FMIN 20. HZ;LUNIT DBFS;MMAX 20. DB;MMIN -60. DB;SPEED FAST;STEPS 0;SWPTYPE FREQ;UNIT DB;:DISPLAY PANEL;

---

## DRATio:SPEEd

Selects the sweep speed.

**Related Commands:** DRATIO:SPEEd?

**Syntax:** DRATIO:SPEEd { FAST | MEdium | SLOW }

**Factory Default:** FAST

**Example:** DRATIO:SPEED MEDIUM

---

## DRATio:SPEEd?

Returns the currently selected sweep speed.

**Related Commands:** DRATIO:SPEEd

**Syntax:** DRATIO:SPEEd?

**Example:** DRATIO:SPEED?

**Response:** SPEED MEDIUM;

---

## DRATio:STEPs

Selects the sweep mode or the number of sweep steps. A step value of 0 selects the 1/3 octave frequency table if a frequency sweep is desired (SWPTtype is FREQ) or 2 dB steps if an amplitude sweep is desired (SWPTtype is AMPL). A step value of -1 selects the external sweep mode if SWPTtype is FREQ. All other values select the internal sweep mode with the indicated number of steps calculated using the FMIN and FMAX values for frequency sweeps and using the AMIN and AMAX values for amplitude sweeps. STEPs -1 (external sweep) is not permitted if SWPTtype is AMPL.

**Related Commands:** DRATIO:EXTernal, DRATIO:FMIN,R ATio:FMAX, DRATIO:STEP

**Syntax:** DRATIO:STEP { -1 | 0 | 3 | 5 | 10 | 15 | 30 | 75 | 150 }

**Factory Default:** 0

**Example:** DRATIO:STEP 75

---

## DRATio:STEPs?

Returns the selected sweep mode or the number of sweep steps selected for the internal sweep mode.

**Related Commands:** DRATio:STEP  
**Syntax:** DRATio:STEPs?  
**Example:** DRATIO:STEP?  
**Response:** STEP 75;

---

## DRATio:SWPType

Specifies that either a frequency sweep or amplitude sweep is to be performed when the SWEEP START command is received. Amplitude sweeps and frequency sweeps proceed from high to low (from FMAX to FMIN and from AMIN to AMAX). The type of sweep is dependent on the currently selected generator (ANALOG, DIGITAL, or JITTER) and the currently selected measurement function. The currently displayed or last-selected generator will be used. SWPType AMPL is not permitted if STEP is -1 (external sweep).

**Related Commands:** GENERator, DGENERator, and measurement function settings STEP, FMAX, FMIN, AMAX, AMIN, EXTERNAL  
**Syntax:** DRATio:SWPType { FREQ | AMPL }  
**Factory Default:** FREQ  
**Example:** DRATIO:SWPTYPE AMPL

---

## DRATio:SWPType?

Returns the setting of the sweep type, indicating that either a frequency sweep or amplitude sweep is to be performed when the SWEEP START command is received.

**Related Commands:** GENERator, DGENERator, and measurement function settings STEP, FMAX, FMIN, AMAX, AMIN, EXTERNAL  
**Syntax:** DRATio:SWPType?  
**Example:** DRATIO:SWPTYPE?  
**Response:** SWPTYPE AMPL

---

## DRATio:UNIT

Selects either X/Y or dB units for the Digital Ratio measurement function.

**Related Commands:** DRATio:UNIT?  
**Syntax:** DRATio:UNIT { X/Y | DB }  
**Factory Default:** DB  
**Example:** DRATIO:UNIT X/Y

---

## DRATio:UNIT?

Returns the currently selected Digital Ratio measurement function units.

**Related Commands:** DRATio:UNIT  
**Syntax:** DRATio:UNIT?  
**Example:** DRATIO:UNIT?  
**Response:** UNIT X/Y;

---

## DTHD:

Compound command header for the Digital THD measurement function parameters.

---

### DTHD:AMAX

This command sets the maximum amplitude level for an amplitude sweep of the analog generator, the digital generator, or the jitter generator when the SWPType command is set to AMPL.

Set the generator type and unit before sending the AMAX command. Subsequent changes to the generator type may cause the AMAX setting to be changed.

The numeric argument and its unit should be within the valid amplitude range of the generator and its waveform type. The maximum level for an amplitude sweep will be the argument value and units for the generator last selected with the GENERator command or selected by the user with the front panel OUTPUT button.

If the AMAX argument value is less than the current setting of the AMIN command but within the range of the generator, then the AMIN command setting will be coerced to a lower value and no error will be generated.

Error 4 “CONFLICT WITH MAXIMUM AMPLITUDE” will be generated if the argument is outside of the range of the generator.

See Section 1 General Information – Sweeps for more information about interactions between amplitude sweep parameters and changes of the currently selected generator.

**Related Commands:** DTHD:AMIN, DTHD:AMAX?, SWPType

**Syntax:** DTHD:AMAX <nrf> unit

**Factory Default:** 1.0 V

**Example:** DTHD:AMAX 0. DBFS

---

### DTHD:AMAX?

Returns the maximum amplitude level set by the AMAX command.

**Related Commands:** DTHD:AMAX

**Syntax:** DTHD:AMAX?

**Example:** DTHD:AMAX?

**Response:** AMAX 0. DBFS;

---

## DTHD:AMIN

Sets the minimum amplitude level for an amplitude sweep for the analog generator, the digital generator, or the jitter generator when the SWPType command is set to AMPL. The numeric argument will use the amplitude unit last specified for the generator last displayed in the front panel (the generator may not be visible in the display depending on the state of the DISPlay command). Thus the minimum level for an amplitude sweep will be the argument value in units currently in force, and will depend on which generator was last displayed.

Error 18 “ARGUMENT OUT OF RANGE” will be generated if the argument value is greater than or equal to the maximum value set by AMAX.

The range of the argument will not be checked until sweep run time. Error 3 “CONFLICT WITH MINIMUM AMPLITUDE” will be generated and SESR bit 4 will be set (EXECUTION ERROR) if the argument is outside of the range of the generator at the time the sweep is started.

Set the generator before using the AMIN command. The AMIN value may be changed if the generator type and/or waveform are changed after receipt of the AMIN command. For example, if the generator is GEN:JITT when AMIN is set to 3.0 (defaults to UI units) and then the generator is set to GEN:DIG, then AMIN will be set to less than the AMAX value and less than the highest amplitude permissible for the digital generator (e.g., 0.99 FFS if AMAX was changed to 1.0 FFS).

**Related Commands:** DTHD:AMIN?, DTHD:AMAX, SWPType

**Syntax:** DTHD:AMIN <nrf> unit

**Factory Default:** 0.0 V

**Example:** DTHD:AMIN -140. DBFS

---

## DTHD:AMIN?

Returns the minimum amplitude level set by the AMIN command.

**Related Commands:** DTHD:AMIN

**Syntax:** DTHD:AMIN?

**Example:** DTHD:AMIN?

**Response:** AMIN -140. DBFS;

---

## DTHD:EXtErnal

Selects glide or step in external sweep mode.

**Related Commands:** DTHD:STEP, DTHD:EXtErnal?

**Syntax:** DTHD:EXtErnal { GLIDe | STEP }

**Factory Default:** GLIDE

**Example:** DTHD:EXTERNAL STEP

---

**DTHD:EXTErnal?**

Returns the current external sweep settling mode.

**Related Commands:** DTHD:EXTErnal

**Syntax:** DTHD:EXTErnal?

**Example:** DTHD:EXTErnal?

**Response:** EXTERNAL STEP;

---

**DTHD:FILTEr**

Selects the filter for the DTHD function, identical to the front-panel selection. The average filter (AVERAge) provides the average of the eight most recent distortion measurements with no weighting filter.

**Related Commands:** DTHD:WTD, DTHD:HPASs, DTHD:LPASs, DTHD:FILTEr?

**Syntax:** DTHD:FILTEr { WTD | UNWTD | AVERAge }

**Factory Default:** UNWTD

**Example:** DTHD:FILTEr WTD

---

**DTHD:FILTEr?**

Returns the current filter for the DTHD function.

**Related Commands:** DTHD:FILTEr

**Syntax:** DTHD:FILTEr?

**Example:** DTHD:FILTEr?

**Response:** FILTER WTD;

---

**DTHD:FMAX**

Selects the upper frequency display range for the sweep display. The frequency sweep step values will be computed using this value.

**Related Commands:** DTHD:FMIN, DTHD:FMAX?

**Syntax:** DTHD:FMAX <nrf> [ HZ ]

**Factory Default:** 20. E+3 HZ

**Example:** DTHD:FMAX 22 KHZ

---

**DTHD:FMAX?**

Returns the current upper frequency range setting for the sweep display.

**Related Commands:** DTHD:FMAX

**Syntax:** DTHD:FMAX?

**Example:** DTHD:FMAX?

**Response:** FMAX 2.2E+4 HZ;

---

**DTHD:FMIN**

Selects the lower frequency display range for the sweep display. The frequency sweep step values will be computed using this value.

**Related Commands:** DTHD:FMIN  
**Syntax:** DTHD:FMIN <nrf> [ HZ ]  
**Factory Default:** 20 HZ  
**Example:** DTHD:FMIN 200

---

**DTHD:FMIN?**

Returns the current lower frequency range setting for the sweep display.

**Related Commands:** DTHD:FMIN  
**Syntax:** DTHD:FMIN?  
**Example:** DTHD:FMIN?  
**Response:** FMIN 2.0E+2 HZ;

---

**DTHD:HPASS**

Selects the high pass filter cut off frequency. Values of 10 Hz, 22 Hz, or 400 Hz may be selected. The filter cut off frequencies are valid only for the standard sampling rates of 32 KHz, 44.1 KHz, 48 KHz, 88.2 KHz, and 96 KHz.

**Related Commands:** DTHD:LPASSs, DTHD:FILTer, DTHD:HPASSs?  
**Syntax:** DTHD:HPASSs [ HP10 | HP22 | HP400 ]  
**Factory Default:** HP10  
**Example:** DTHD:HPASS HP400

---

**DTHD:HPASS?**

Returns the high pass filter cut off frequency in Hz units.

**Related Commands:** DTHD:HPASSs  
**Syntax:** DTHD:HPASSs?  
**Example:** DTHD:HPASS?  
**Response:** HPASS HP400;

---

**DTHD:LPASS**

Selects the band pass filter cut off frequency and detector when the unweighted filter or average filter is selected. Selections are: 15 kHz RMS (R15k), 20 kHz RMS (R20k), Half Sample Rate (HALFrate), 22 kHz RMS (R22k), 22 kHz QPEAK (Q22k). The filter cut off frequencies are valid only for the standard sampling rates of 32 KHz, 44.1 KHz, 48 KHz, 88.2 KHz, and 96 KHz.

**Related Commands:** DTHD:HPASSs, DTHD:FILTer, DTHD:LPASSs?  
**Syntax:** DTHD:LPASSs { R15k | R20k | HALFrate | R22k | Q22k }  
**Factory Default:** HALF RATE  
**Example:** DTHD:LPASS R22K

---

**DTHD:LPASS?**

Returns the current low pass filter setting and detector selection to be used when the UNWTD or AVG filters are selected.

**Related Commands:** DTHD:LPASSs

**Syntax:** DTHD:LPASS?

**Example:** DTHD:LPASS?

**Response:** LPASS R22K;

---

**DTHD:LUNit**

Selects the measurement units for the Digital Level measurement in the DTHD function. OFF turns off the level measurement display.

**Related Commands:** DTHD:LUNit?, REFDBR

**Syntax:** DTHD:LUNit { FFS | DBFS | DBR }

**Factory Default:** DBFS

**Example:** DTHD:LUNIT DBFS

---

**DTHD:LUNit?**

Returns the current measurement units for the Digital Level measurement in the DTHD function.

**Related Commands:** DTHD:LUNit

**Syntax:** DTHD:LUNit?

**Example:** DTHD:LUNIT?

**Response:** LUNIT DBFS;

---

**DTHD:MMAx**

Selects the upper magnitude display range for the sweep and bargraph displays in currently selected units. The selected units will be the displayed units only if the bargraph or sweep is being displayed when this command is received.

**Related Commands:** DTHD:MMIN, DTHD:MMAx?

**Syntax:** DTHD:MMAx <nrf> [ PCT | DB | FFS | DBFS | DBR ]

**Factory Default:** -40. DB

**Example:** DTHD:MMAx 5 PCT

---

**DTHD:MMAx?**

Returns the current upper magnitude range setting for the sweep and bargraph displays in currently selected units.

**Related Commands:** DTHD:MMAx

**Syntax:** DTHD:MMAx?

**Example:** DTHD:MMAx?

**Response:** MMAx 5. PCT;

---

**DTHD:MMIN**

Selects the lower magnitude display range for the sweep display. The selected units will be the displayed units only if the bargraph or sweep is being displayed when this command is received.

**Related Commands:** DTHD:MMAx, DTHD:MMIN?

**Syntax:** DTHD:MMIN <nrf> [ PCT | DB | FFS | DBFS | DBR ]

**Factory Default:** -120. DB

**Example:** DTHD:MMIN 0.2 PCT

---

**DTHD:MMIN?**

Returns the current upper magnitude range setting for the sweep and bargraph displays in currently selected units.

**Related Commands:** DTHD:MMIN

**Syntax:** DTHD:MMIN?

**Example:** DTHD:MMIN?

**Response:** MMIN 2.0E-1 PCT;

---

**DTHD:NOTChfreq**

Selects the center frequency for the tunable notch filter when TUNE is set to FIXTune. The HZ unit is optional.

**Related Commands:** DTHD:TUNe, DTHD:NOTChfreq?

**Syntax:** DTHD:NOTChfreq <nrf> [ HZ ]

**Factory Default:** 1. E+3 HZ

**Example:** DTHD:NOTCHFREQ 5000

---

**DTHD:NOTChfreq?**

Returns the selected center frequency for the tunable notch filter when TUNE is set to FIXTune.

**Related Commands:** DTHD:NOTChfreq

**Syntax:** DTHD:NOTChfreq?

**Example:** DTHD:NOTCHFREQ?

**Response:** NOTCHFREQ 5.0E+3 HZ;

---

## DTHD:SET?

Returns the query responses for all the queries under the :DTHD: compound command header. The response is preceded by :DISP GPIB and followed by :DISPLAY *current\_display\_panel*. Equivalent to sending the following query string:

```
DTHD:AMAX?;AMIN?;EXTERNAL?;FILTER?;FMAX?;FMIN?;HPASS?;LPASS?;LUNIT?;MMAX?;MMIN?;NOTCHFREQ?;SPEED?;STEPS?;SWPTYPE?;TUNE?;UNIT?;WTD?;:DISPLAY?
```

**Related Commands:** All DTHD: queries

**Syntax:** DTHD:SET?

**Example:** DTHD:SET?

**Response:** :DISP GPIB;:DTHD:AMAX 1. V;AMIN 0. V;EXTERNAL GLIDE;FILTER UNWTD;FMAX 20.E+3 HZ;FMIN 20. HZ;HPASS HP10;LPASS HALFRATE;LUNIT DBFS;MMAX -40. DB;MMIN -120. DB;NOTCHFREQ 1.E+3 HZ;SPEED FAST;STEPS 0;SWPTYPE FREQ;TUNE AUTO;UNIT DB;WTD IECA;:DISPLAY PANEL;

---

## DTHD:SPEEd

Selects the sweep speed.

**Related Commands:** DTHD:SPEEd?

**Syntax:** DTHD:SPEEd { FAST | MEDium | SLOW }

**Factory Default:** FAST

**Example:** DTHD:MEDIUM

---

## DTHD:SPEEd?

Returns the currently selected sweep speed.

**Related Commands:** DTHD:SPEEd

**Syntax:** DTHD:SPEEd?

**Example:** DTHD:SPEED?

**Response:** SPEED MEDIUM;

---

## DTHD:STEPS

Selects the sweep mode or the number of sweep steps. A step value of 0 selects the 1/3 octave frequency table if a frequency sweep is desired (SWPTtype is FREQ) or 2 dB steps if an amplitude sweep is desired (SWPTtype is AMPL). A step value of -1 selects the external sweep mode, all other values select the internal sweep mode with the indicated number of steps calculated using the FMIN and FMAX values for frequency sweeps and using the AMIN and AMAX values for amplitude sweeps. STEPs -1 (external sweep) is not permitted if SWPTtype is AMPL.

**Related Commands:** DTHD:EXTernal, DTHD:FMIN, DTHD:FMAX, DTHD:STEP?

**Syntax:** DTHD:STEP { -1 | 0 | 3 | 5 | 10 | 15 | 30 | 75 | 150 }

**Factory Default:** 0

**Example:** DTHD:STEP -1

---

## DTHD:STEPS?

Returns the selected sweep mode or the number of sweep steps selected for the internal sweep mode.

**Related Commands:** DTHD:STEP  
**Syntax:** DTHD:STEPS?  
**Example:** DTHD:STEP?  
**Response:** STEP -1;

---

## DTHD:SWPType

Specifies that either a frequency sweep or amplitude sweep is to be performed when the SWEEP START command is received. Amplitude sweeps and frequency sweeps proceed from high to low (from FMAX to FMIN and from AMIN to AMAX). The type of sweep is dependent on the currently selected generator (ANALOG, DIGITAL, or JITTER) and the currently selected measurement function. The currently displayed or last-selected generator will be used. SWPType AMPL is not permitted if STEPS is -1 (external sweep).

**Related Commands:** GENerator, DGENerator, and measurement function settings STEP, FMAX, FMIN, AMAX, AMIN, EXTernal  
**Syntax:** DTHD:SWPType { FREQ | AMPL }  
**Factory Default:** FREQ  
**Example:** DTHD:SWPTYPE AMPL

---

## DTHD:SWPType?

Returns the setting of the sweep type, indicating that either a frequency sweep or amplitude sweep is to be performed when the SWEEP START command is received.

**Related Commands:** GENerator, DGENerator, and measurement function settings STEP, FMAX, FMIN, AMAX, AMIN, EXTernal  
**Syntax:** DTHD:SWPType?  
**Example:** DTHD:SWPTYPE?  
**Response:** SWPTYPE AMPL;

---

## DTHD:TUNE

Selects the notch filter tuning mode for the DTHD function.

**Related Commands:** DTHD:NOTChfreq, DTHD:TUNe?  
**Syntax:** DTHD:TUNe { AUTo | GENTrack | FIXTune }  
**Factory Default:** AUTO  
**Example:** DTHD:TUNE FIXTUNE

---

**DTHD:TUNe?**

Returns the notch filter tuning mode for the DTHD function.

**Related Commands:** DTHD:TUNe  
**Syntax:** DTHD:TUNe?  
**Example:** DTHD:TUNE?  
**Response:** TUNE FIXTUNE;

---

**DTHD:UNIT**

Selects the measurement units for the DTHD function.

**Related Commands:** DTHD:UNIT?, DREFDBR  
**Syntax:** DTHD:UNIT { PCT | DB | FFS | DBFS | DBR }  
**Factory Default:** PCT  
**Example:** DTHD:UNIT DB

---

**DTHD:UNIT?**

Returns the current units for the DTHD function.

**Related Commands:** DTHD:UNIT  
**Syntax:** DTHD:UNIT?  
**Example:** DTHD:UNIT?  
**Response:** UNIT DB;

---

**DTHD:WTD**

Selects the weighting filter for the DTHD+N function when the WTD filter is selected. The choices are the same ones available from the front panel.

**Related Commands:** DTHD:FILTER, DTHD:WTD?  
**Syntax:** DTHD:WTD { IECA | RMSCcir | CCIR2K | QPKCcir }  
**Factory Default:** IECA  
**Example:** DTHD:WTD CCIR2K

---

**DTHD:WTD?**

Returns the currently selected weighting filter for the DTHD+N function.

**Related Commands:** DTHD:WTD  
**Syntax:** DTHD:WTD?  
**Example:** DTHD:WTD?  
**Response:** WTD CCIR2K;

---

## DXTalk:

Compound command header for the Digital DXTALK measurement parameters.

---

### DXTalk:AMAX

This command sets the maximum amplitude level for an amplitude sweep of the analog generator, the digital generator, or the jitter generator when the SWPType command is set to AMPL.

Set the generator type and unit before sending the AMAX command. Subsequent changes to the generator type may cause the AMAX setting to be changed.

The numeric argument and its unit should be within the valid amplitude range of the generator and its waveform type. The maximum level for an amplitude sweep will be the argument value and units for the generator last selected with the GENERator command or selected by the user with the front panel OUTPUT button.

If the AMAX argument value is less than the current setting of the AMIN command but within the range of the generator, then the AMIN command setting will be coerced to a lower value and no error will be generated.

Error 4 “CONFLICT WITH MAXIMUM AMPLITUDE” will be generated if the argument is outside of the range of the generator.

See Section 1 General Information – Sweeps for more information about interactions between amplitude sweep parameters and changes of the currently selected generator.

**Related Commands:** DXTalk:AMIN, DXTalk:AMAX?, SWPType

**Syntax:** DXTalk:AMAX <nrf> unit

**Factory Default:** 1.0 V

**Example:** DXTALK:AMAX 0. DBFS

---

### DXTalk:AMAX?

Returns the maximum amplitude level set by the AMAX command.

**Related Commands:** DXTalk:AMAX

**Syntax:** DXTalk:AMAX?

**Example:** DXTALK:AMAX?

**Response:** AMAX 0. DBFS;

---

### DXTalk:AMIN

Sets the minimum amplitude level for an amplitude sweep for the analog generator, the digital generator, or the jitter generator when the SWPType command is set to AMPL. The numeric argument will use the amplitude unit last specified for the generator last displayed in the front panel (the generator may not be visible in the display depending on the state of the DISPlay command). Thus the minimum level for an amplitude sweep will be the argument value in units currently in force, and will depend on which generator was last displayed.

Error 18 “ARGUMENT OUT OF RANGE” will be generated if the argument value is greater than or equal to the maximum value set by AMAX.

The range of the argument will not be checked until sweep run time. Error 3 “CONFLICT WITH MINIMUM AMPLITUDE” will be generated and SESR bit 4 will be set (EXECUTION ERROR) if the argument is outside of the range of the generator at the time the sweep is started.

Set the generator before using the AMIN command. The AMIN value may be changed if the generator type and/or waveform are changed after receipt of the AMIN command. For example, if the generator is GEN:JITT when AMIN is set to 3.0 (defaults to UI units) and then the generator is set to GEN:DIG, then AMIN will be set to less than the AMAX value and less than the highest amplitude permissible for the digital generator (e.g., 0.99 FFS if AMAX was changed to 1.0 FFS).

**Related Commands:** DXTalk:AMIN?, DXTalk:AMAX, SWPType

**Syntax:** DXTalk:AMIN <nrf> unit

**Factory Default:** 0. V

**Example:** DXTALK:AMIN -140. DBFS

---

## DXTalk:AMIN?

Returns the minimum amplitude level set by the AMIN command.

**Related Commands:** DXTalk:AMIN

**Syntax:** DXTalk:AMIN?

**Example:** DXTALK:AMIN?

**Response:** AMIN -140. DBFS;

---

## DXTalk:EXTernal

Selects glide or step settling in external sweep mode.

**Related Commands:** DXTalk:STEP, DXTalk:EXTernal?

**Syntax:** DXTALK:EXTernal { GLIDe | STEP }

**Factory Default:** GLIDE

**Example:** DXTALK:STEP

---

## DXTalk:EXTernal?

Returns the current external sweep settling mode.

**Related Commands:** DXTalk:EXTernal

**Syntax:** DXTALK:EXTernal?

**Example:** DXTALK:EXTERNAL?

**Response:** EXTERNAL STEP;

---

## DXTalk:FMAX

Selects the upper frequency display range for the sweep display. The frequency sweep step values will be computed using this value.

**Related Commands:** DXTalk:FMIN, DXTalk:FMAX?, GAMplitude, GFREquency, WAVEform

**Syntax:** DXTalk:FMAX <nrf> [ HZ ]

**Factory Default:** 20. E+3 HZ

**Example:** DXTALK:FMAX 16.0E+3 HZ

---

## DXTalk:FMAX?

Returns the current upper frequency range setting for the sweep display.

**Related Commands:** DXTalk:FMAX

**Syntax:** DXTalk:FMAX?

**Example:** DXTALK:FMAX?

**Response:** FMAX 1.6E+4 HZ;

---

## DXTalk:FMIN

Selects the lower frequency display range for the sweep display. The frequency sweep step values will be computed using this value.

**Related Commands:** DXTalk:FMAX, DXTalk:FMIN?

**Syntax:** DXTalk:FMIN <nrf> [ HZ ]

**Factory Default:** 20. HZ

**Example:** DXTALK:FMIN 100 HZ

---

## DXTalk:FMIN?

Returns the current lower frequency range setting for the sweep display.

**Related Commands:** DXTalk:FMAX, DXTalk:FMIN?

**Syntax:** DXTalk:FMIN <nrf> [ HZ ]

**Factory Default:** 20 HZ

**Example:** DXTALK:FMIN?

**Response:** FMIN 1.0E+2 HZ;

---

## DXTalk:LUNit

Selects the level measurement units for the DXTALK function. OFF turns off the level measurement display.

**Related Commands:** DXTalk:LUNit, REFDBR

**Syntax:** DXTalk:LUNit { FFS | DBFS | DBR }

**Factory Default:** DBFS

**Example:** DXTALK:LUNIT DBFS

---

**DXTalk:LUNit?**

Returns the currently selected level measurement units for the DXTALK function.

**Related Commands:** DXTalk:LUNIT

**Syntax:** DXTalk:LUNit?

**Example:** DXTALK:LUNIT?

**Response:** LUNIT DBFS;

---

**DXTalk:MMAx**

Selects the upper magnitude display range for the sweep and bargraph displays in currently selected units. The selected units will be the displayed units only if the bargraph or sweep is being displayed when this command is received.

**Related Commands:** DXTalk:MMIN, DXTalk:MMAx?, REFDBR

**Syntax:** DXTalk:MMAx <nrf> [ DB | X/Y ]

**Factory Default:** 0 DB

**Example:** DXTALK:MMAx 10 DB

---

**DXTalk:MMAx?**

Returns the current upper magnitude range setting for the sweep and bargraph displays in currently selected units.

**Related Commands:** DXTalk:MMAx

**Syntax:** DXTalk:MMAx?

**Example:** DXTALK:MMAx?

**Response:** MMAx 1.0E+1 DB;

---

**DXTalk:MMIN**

Selects the lower magnitude display range for the sweep display. The selected units will be the displayed units only if the bargraph or sweep is being displayed when this command is received.

**Related Commands:** DXTalk:MMAx, DXTalk:MMIN?, REFDBR

**Syntax:** DXTalk:MMIN <nrf> [ DB | X/Y ]

**Factory Default:** -120 DB

**Example:** DXTALK:MMIN -60 DB

**Response:** MMIN -60. DB;

---

**DXTalk:MMIN?**

Returns the current upper magnitude range setting for the sweep and bargraph displays in currently selected units.

**Related Commands:** DXTalk:MMIN

**Syntax:** DXTalk:MMIN?

**Example:** DXTALK:MMIN?

**Response:** MMIN -6.0E+1 DB;

---

## DXTalk:SET?

Returns the query responses for all the queries under the :DXTALK: compound command header. The response is preceded by :DISP GPIB and followed by :DISPLAY *current\_display\_panel*. Equivalent to sending the following query string:

```
:DXTALK:AMAX?;AMIN?;EXTERNAL?;FMAX?;FMIN?;LUNIT?;MMAX?;MMIN?;SPEED?;STEPS?;SWPTYPE?;UNIT?;:DISPLAY?
```

**Related Commands:** All DXTalk: queries

**Syntax:** DXTalk:SET?

**Example:** DXTALK:SET?

**Response:** :DISP GPIB;:DXTALK:AMAX 1. V;AMIN 0. V;EXTERNAL GLIDE;FMAX 20.E+3 HZ;FMIN 20. HZ;LUNIT DBFS;MMAX 0. DB;MMIN -120. DB;SPEED FAST;STEPS 0;SWPTYPE FREQ;UNIT DB;:DISPLAY PANEL;

---

## DXTalk:SPEEd

Selects the sweep speed.

**Related Commands:** DXTalk:SPEEd?

**Syntax:** DXTalk:SPEEd { FAST | MEDium | SLOW }

**Factory Default:** FAST

**Example:** DXTALK:SPEED MEDIUM

---

## DXTalk:SPEEd?

Returns the currently selected sweep speed.

**Related Commands:** DXTalk:SPEEd

**Syntax:** DXTalk:SPEEd?

**Example:** DXTALK:SPEED?

**Response:** SPEED MEDIUM;

---

## DXTalk:STEPS

Selects the sweep mode or the number of sweep steps. A step value of 0 selects the 1/3 octave frequency table if a frequency sweep is desired (SWPTtype is FREQ) or 2 dB steps if an amplitude sweep is desired (SWPTtype is AMPL). A step value of -1 selects the external sweep mode if SWPTtype is FREQ. All other values select the internal sweep mode with the indicated number of steps calculated using the FMIN and FMAX values for frequency sweeps and using the AMIN and AMAX values for amplitude sweeps. STEPS -1 (external sweep) is not permitted if SWPTtype is AMPL.

**Related Commands:** DXTalk:EXTernal, DXTalk:STEPS?, DXTalk:FMIN, DXTalk:FMAX

**Syntax:** DXTalk:STEP { -1 | 0 | 3 | 5 | 10 | 15 | 30 | 75 | 150 }

**Factory Default:** 0

**Example:** DXTALK:STEP 3

---

**DXTalk:STEPS?**

Returns the selected sweep mode or the number of sweep steps selected for the internal sweep mode.

**Related Commands:** DXTalk:STEP  
**Syntax:** DXTalk:STEPS?  
**Example:** DXTALK:STEPS?  
**Response:** STEP 3;

---

**DXTalk:SWPType**

Specifies that either a frequency sweep or amplitude sweep is to be performed when the SWEEP START command is received. Amplitude sweeps and frequency sweeps proceed from high to low (from FMAX to FMIN and from AMIN to AMAX). The type of sweep is dependent on the currently selected generator (ANALOG, DIGITAL, or JITTER) and the currently selected measurement function. The currently displayed or last-selected generator will be used. SWPType AMPL is not permitted if STEPS is -1 (external sweep).

**Related Commands:** GENERator, DGENERator, and measurement function settings STEP, FMAX, FMIN, AMAX, AMIN, EXTernal  
**Syntax:** DXTalk:SWPType { FREQ | AMPL }  
**Factory Default:** FREQ  
**Example:** DXTALK:SWPTYPE AMPL

---

**DXTalk:SWPType?**

Returns the setting of the sweep type, indicating that either a frequency sweep or amplitude sweep is to be performed when the SWEEP START command is received.

**Related Commands:** GENERator, DGENERator, and measurement function settings STEP, FMAX, FMIN, AMAX, AMIN, EXTernal  
**Syntax:** DXTalk:SWPType?  
**Example:** DXTALK:SWPTYPE?  
**Response:** SWPTYPE AMPL;

---

**DXTalk:UNIT**

Selects the DXTALK measurement units.

**Related Commands:** DXTalk:UNIT?, REFDBR  
**Syntax:** DXTalk:UNIT [ DB | X/Y ]  
**Factory Default:** DB  
**Example:** **DXTALK:UNIT X/Y**

---

**DXTalk:UNIT?**

Returns the currently selected DXTALK measurement units.

**Related Commands:** DXTalk:UNIT  
**Syntax:** DXTalk:UNIT?  
**Example:** DXTALK:UNIT?  
**Response:** UNIT X/Y;



# 8. Digital Output Status Command Descriptions

This section describes alphabetically the Digital Output Status commands for the Portable One Dual Domain instrument, as listed in Section 1. Refer to Section 1 for a list of all commands by command groups, and for command notation and syntax. This section applies to Dual Domain instruments only.

---

## DOSTatus:

Compound command header for the Digital Output Status setup commands and queries.

The Digital Output Status bits for Professional and Consumer standards are different but share some attributes. The front panel status bits display provides the ability to set the bits for the currently displayed standard only, either Professional or Consumer. Changing the shared attributes for Professional will change the same settings for Consumer and vice versa. The state of these two modes is coupled.

This coupling also exists for the GPIB commands. For example, the Professional mode can be selected and the Professional mode status bits specified with the GPIB command `:DOSTATUS:STDO PROF;PROF NI,J17,SRC1,DES1`. Likewise the Consumer mode can be selected and the Consumer mode status bits specified with the GPIB command `:DOSTATUS:STDO CONS;CONS R48K,CD,OK`. A change to the status bits specified for the Consumer mode with the `CONS` command will affect the status bits specified for the Professional mode by the `PROF` command and vice versa in the same manner that the front panel menu sets these status bits.

To avoid unexpected behavior, select the standard you want to use with the `:DOSTATUS:STDO` command and then set the parameters for that standard and do not set parameters for the other standard. For example, the command string `:DOSTATUS:STDO PROF;PROF NI,J17,SRC1,DES1` specifies the professional standard with rate of Not Indicated, emphasis J17, source SRC1 and destination DES1. Do not send the `CONS` command because it will change some of the professional parameters.

For professional standard always send the `:DOSTATUS:STDO PROF` command followed by the `:DOSTATUS:PROF` command. For the consumer standard always send the `:DOSTATUS:STDO CONS` command followed by the `:DOSTATUS:CONS` command.

The tables below describe the coupling between the `CONS` command parameters and the `PROF` command parameters. The state of the instrument is dependent on the last command received.

Changes to PROF state when CONS command is received.			
Consumer Rate	Professional Rate	Consumer Emphasis	Professional Emphasis
<b>AUTO</b>	<b>AUTO</b>	<b>NONE</b>	<b>NONE</b>
<b>R32K</b>	<b>R32K</b>	<b>CD</b>	<b>CD</b>
<b>R44K</b>	<b>R44K</b>		
<b>R48K</b>	<b>R48K</b>		

Changes to CONS state when PROF command is received.			
Professional Rate	Consumer Rate	Professional Emphasis	Consumer Emphasis
<b>AUTO</b>	<b>AUTO</b>	<b>NONE</b>	<b>NONE</b>
<b>R32K</b>	<b>R32K</b>	<b>CD</b>	<b>CD</b>
<b>R44K</b>	<b>R44K</b>	<b>J17</b>	<b>NONE</b>
<b>R48K</b>	<b>R48K</b>	<b>NI</b>	<b>NONE</b>
<b>NI</b>	<b>AUTO</b>		

## DOSTatus:CONS

Specifies the consumer standard status bit settings for the rate, emphasis, and copy bits. These are the settings that will be set when the consumer standard is enabled with the `STDO CONS` command. These settings are affected by the `:DOSTATUS:PROF` command. Three arguments specify the sample rate status bits, the emphasis status, and the copy bit status bit. The first argument indicates sample rate. The second argument indicates digital output pre-emphasis. The third argument indicates copyright protection. The sample rate parameter may be set to `AUTO` (set by output sample rate), `R32K` (32000 s/sec), `R44K` (44100 s/sec), or `R48K` (48000 s/sec). The emphasis parameter may be `NONE` (no emphasis) or `CD` (50/15  $\mu$ s pre-emphasis). The copy parameters may be `NO` (copy prohibited) or `OK` (copy permitted).

**Related Commands:** `:DOSTatus:CONS?`, `:DOSTatus:PROF`

**Syntax:** `:DOSTatus:CONS rate { AUTO | R32K | R44K | R48K }, emphasis { NONE | CD }, copy { NO | OK }`

**Factory Default:** `CONS AUTO, NONE, NO`

**Example:** `:DOSTATUS:CONS R44K, CD, OK`

---

## DOSTatus:CONS?

Returns the present consumer standard status bit settings for the sample rate status bits, emphasis status bits, and copy status bit. These settings are affected by the :DOSTATUS:PROF command. These are the settings that will be transmitted when the consumer standard is enabled with the STDO CONS command. Three return arguments specify the rate, the emphasis, and the copy bit. Refer to the DOSTatus CONS command above for more details.

**Related Commands:** :DOSTatus:CONS, :DOSTatus:PROF

**Syntax:** :DOSTatus:CONS?

**Example:** :DOSTATUS:CONS?

**Response:** :DOSTATUS:CONS R44K,CD,OK

---

## DOSTatus:PROF

Specifies the professional standard status bit settings for the rate, output pre-emphasis, origination, and destination status bits. These settings are affected by the :DOSTATUS:CONS command. These are the settings that will be set when the professional standard is enabled with the STDO PROF command. Four arguments specify the rate, the emphasis, the four-character origination string, and the four-character destination string. The first argument indicates sample rate. The second argument indicates digital output pre-emphasis. The third argument indicates the origination string. The fourth argument indicates the destination string.

The sample rate parameter may be set to AUTO (set by output sample rate), NI (Not Indicated), R32K (32000 s/sec), R44K (44100 s/sec), or R48K (48000 s/sec). The emphasis parameter may be NONE (no emphasis), CD (50/15  $\mu$ s pre-emphasis), J17 (CCITT J17 pre-emphasis), or NI (Not Indicated). The origination string may be set to NULL, AP1D, SRC1, SRC2, SRC3, or TEST. The destination string may be set to NULL, AP1D, DES1, DES2, DES3, or TEST.

**Related Commands:** :DOSTatus:PROF?, :DOSTatus:CONS

**Syntax:** :DOSTatus:PROF *rate* { AUTO | NI | R32K | R44K | R48K },  
*emphasis* { NONE, CD, J17, NI },  
*origination* { NULL | AP1D | SRC1 | SRC2 | SRC3 | TEST },  
*destination* { NULL | AP1D | DES1 | DES2 | DES3 | TEST }

**Factory Default:** PROF AUTO, NI, NULL, NULL

**Example:** :DOSTATUS:PROF R48K,NONE,SRC1,DES1

---

## DOSTatus:PROF?

Returns the present professional standard status bit settings for the rate, output pre-emphasis, origination, and destination status bits. These settings are affected by the :DOST:CONS command. These are the settings that will be transmitted when the professional standard is enabled with the STD PROF command. Four arguments specify the rate, the emphasis, the four-character origination string, and the four-character destination string. The first argument indicates sample rate. The second argument indicates digital output pre-emphasis. The third argument indicates the origination string. The fourth argument indicates the destination string. Refer to the DOSTatus PROF command above for more details.

**Related Commands:** :DOSTatus:PROF, :DOSTatus:CONS

**Syntax:** :DOSTatus:PROF?

**Example:** :DOSTATUS:PROF?

**Response:** PROF R48K,NONE, SRC1, DES1;

---

## DOSTatus:SET?

Returns the query responses for all the queries under the :DOSTatus: compound command header that are relevant for the standard currently selected by the :DOST:STDO command.

If the professional standard is currently selected, then this command is equivalent to sending the following query string:

:DOSTATUS:STDO?; PROF?; VALIDITY?

If the consumer standard is currently selected, then this command is equivalent to sending the following query string:

:DOSTATUS:STDO?; CONS?; VALIDITY?

**Related Commands:** All DOSTatus queries

**Syntax:** DOSTatus:SET?

**Example:** :DOSTATUS:SET?

**Response:** :DOSTATUS:STDO CONS; CONS R48K, CD, NO; VALIDITY  
VALID;

---

## DOSTatus:STDO

Sets the standard for output status bits formatting, either professional standard (PROF) or consumer standard (CONS). The status bits will be transmitted according to the settings for the PROF and CONS commands above.

**Related Commands:** :DOSTatus:STDO?

**Syntax:** :DOSTatus:STDO { PROF | CONS }

**Factory Default:** PROF

**Example:** :DOSTATUS:STDO CONS

---

## DOSTatus:STDO?

Returns the current setting for the standard for output status bits formatting, either professional standard (PROF) or consumer standard (CONS).

**Related Commands:** :DOSTatus:STDO

**Syntax:** :DOSTatus:STDO?

**Example:** :DOSTATUS:STDO?

**Response:** STDO CONS;

---

## DOSTatus:VALidity

Sets the VALIDITY bit for the digital interface output channel A & B data streams to either VALID or INVALID.

**Related Commands:** :DOSTatus:VALidity?

**Syntax:** :DOSTatus:VALidity { VALID | INVALID }

**Factory Default:** VALID

**Example:** :DOSTATUS:VALIDITY INVALID

---

## DOSTatus:VALidity?

Returns the setting of the digital interface output channel A & B validity bit, set as either VALID or INVALID.

**Related Commands:** DOSTatus:VALidity

**Syntax:** DOSTatus?:VALidity?

**Example:** DOSTATUS:VALIDITY?

**Response:** VALIDITY INVALID;



# 9. Digital Input Status Command Descriptions

This section describes alphabetically the Digital Input Status commands for the Dual Domain instrument, as listed in Section 1. Refer to Section 1 for a list of all commands by command groups, and for command notation and syntax. This section applies to Dual Domain instruments only.

---

## DISTatus:

Compound command header for the Digital Input Status queries.

---

### DISTatus:CODing?

Returns a value indicating a coding error in the data received at the digital interface input. A response of 0 indicates no coding error. A response of 1 indicates a coding error, audio data may be corrupted.

**Related Commands:** None

**Syntax:** DISTatus:CODing?

**Example:** DISTATUS:CODING?

**Response:** CODING 1;

---

### DISTatus:CONFidence?

Returns the confidence state of digital interface input. A response of 0 indicates the confidence flag is not set (no error). A response of 1 indicates the confidence flag is set (error) and audio data may be corrupt.

**Related Commands:** None

**Syntax:** DISTatus:CONFidence?

**Example:** DISTATUS:CONFIDENCE?

**Response:** CONFIDENCE 1;

---

### DISTatus:ERROR?

This query returns a summary of the state of the error flags for the digital input signal. These error flags are coding, confidence, lock, parity, and validity.

The following table shows the bit encoding for the decimal return value.

	Confidence	Lock	Coding	Parity	Invalid
Bit	5	4	3	2	1
Value	16	8	4	2	1

For example, a response of 12 would indicate that Lock flag and the Coding flag were set. A response of 0 indicates no errors of any kind.

**Related Commands:** :DISTATUS:CODING?, :DISTATUS:CONFIDENCE?, :DISTATUS:INVALID?, :DISTATUS:LOCK?, :DISTATUS:PARITY?

**Syntax:** :DISTATUS:ERROR?

**Example:** :DISTATUS:ERROR?

**Response:** ERROR 20

---

## DISTatus:INValid?

Returns the state of digital interface input channel A validity bit. A response of 0 indicates the audio data is Valid. A response of 1 indicates the audio data is Invalid.

**Related Commands:** None

**Syntax:** DISTatus:INValid?

**Example:** DISTATUS : INVALID?

**Response:** INVALID 1;

---

## DISTatus:LOCK?

Returns a value indicating loss of phase lock of the digital interface input to the incoming sample rate. A response of 0 indicates no locking error. A response of 1 indicates a locking error, audio data may be corrupted.

**Related Commands:** None

**Syntax:** DISTatus:LOCK?

**Example:** DISTATUS : LOCK?

**Response:** LOCK 1;

---

## DISTatus:PARity?

Returns a value indicating the received parity bit does not match the parity of the received sample. A response of 0 indicates no parity error. A response of 1 indicates a parity error, audio data may be corrupted.

**Related Commands:** None

**Syntax:** DISTatus:PARity?

**Example:** DISTATUS : PARITY?

**Response:** PARITY 1;

---

## DISTatus:STATus?

Decodes the received status bits and returns the two possible sets of status bit information depending on the standard being received as indicated by the :DISTatus:STD? query response. If Consumer standard status is being received then three arguments will be returned. If Professional standard status is being received then four arguments will be returned.

If Consumer standard is being received then received status bits will be decoded and the following data will be returned in three consecutive arguments: the sample rate, the audio pre-emphasis, and the copy permission. The first argument indicates the encoded sample rate. The second argument indicates the digital pre-emphasis of the received audio. The third argument indicates the copyright protection status. The sample rate parameter may be R32K (32000 samples/second), R44K (44100 samples/second), or R48K (48000 samples/second). The emphasis parameter may be NONE (no emphasis) or CD (50/15  $\mu$ s pre-emphasis). The copy parameter may be NO (copy prohibited) or OK (copy permitted).

If Professional standard is being received the received status bits will be decoded and the following data will be returned in four arguments: the sample rate, the audio pre-emphasis, the four-character origination string, and the four-character destination string. The sample rate may be indicated by NI (Not Indicated), R32K (32000 samples/second), R44K (44100 samples/second), or R48K (48000 samples/second). The emphasis parameter may be NONE (no emphasis), CD (50/15  $\mu$ s pre-emphasis), J17 (CCITT J17 pre-emphasis), or NI (Not Indicated). The origination and destination strings will be delimited in double quotation characters (“”) and may be up to four characters in length.

**Related Commands:** :DISTatus:STATus?, :DISTatus:STD?

**Syntax:** :DISTatus:STATus?

**Example:** :DISTATUS:STATUS?

**Response:** Consumer standard response: STATUS R44K,CD,OK

**Response:** Professional standard response: STATUS  
R48K,NONE,“ABCD”,“WXYZ”;

---

## DISTatus:STDI?

Returns the received digital input status bit standard, either professional standard (PROF) or consumer standard (CONS).

**Related Commands:** none

**Syntax:** :DISTatus:STDI?, :DISTatus:STATus?

**Example:** :DISTATUS:STDI?

**Response:** STDI CONS;



# Appendix A – ASCII Code Chart and IEEE-488 Codes

HEX	0	1	2	3	4	5	6	7
0	0 NUL	20 DLE	40 SP	60 0	100 @	120 P	140 '	160 p
1	1 SOH	21 DC1	41 !	61 1	101 A	121 Q	141 a	161 q
2	2 STX	22 DC2	42 "	62 2	102 B	122 R	142 b	162 r
3	3 ETX	23 DC3	43 #	63 3	103 C	123 S	143 c	163 s
4	4 EOT	24 DC4	44 \$	64 4	104 D	124 T	144 d	164 t
5	5 ENQ	25 NAK	45 %	65 5	105 E	125 U	145 e	165 u
6	6 ACK	26 SYN	46 &	66 6	106 F	126 V	146 f	166 v
7	7 BEL	27 ETB	47 ,	67 7	107 G	127 W	147 g	167 w
8	8 BS	28 CAN	48 (	68 8	108 H	128 X	148 h	168 x
9	9 HT	29 EM	49 )	69 9	109 I	129 Y	149 i	169 y
A	A LF	30 SUB	50 *	70 :	110 J	130 Z	150 j	170 z
B	B VT	31 ESC	51 +	71 ;	111 K	131 [	151 k	171 {
C	C FF	32 FS	52 ,	72 <	112 L	132 \	152 l	172 
D	D CR	33 GS	53 -	73 =	113 M	133 ]	153 m	173 }
E	E SO	34 RS	54 .	74 >	114 N	134 ^	154 n	174 ~
F	F SI	35 US	55 /	75 ?	115 O	135 _	155 o	175 DEL
	Addressed Commands	Universal Commands	Listen Addresses		Talk Addresses		Secondary Addresses	

**KEY**

octal  
hex

10	GET
BS	
8	8

GPIB code  
ASCII character  
decimal



# Appendix B – Factory Default Power-On Settings

The current state of all controls and functions is remembered in non-volatile RAM when the instrument power is turned off. When power is turned on the instrument retrieves these settings from the non-volatile memory to restore the instrument setup.

Pressing the front panel dBR ZERO button while turning power on restores the factory default settings shown in the table below. The GPIB address is set to address 31 which puts the instrument off line, disabling it from participating in GPIB communications. The delimiter is set to EOI.

Commands unique to the Portable One Dual Domain are indicated with *P1DD*.

## System Commands

DATE	Real Time Clock
DTIME	Real Time Clock
DISPLAY	PANEL
DTRGOUT <i>P1DD</i>	XMTFRAME
GENERATOR <i>P1DD</i>	ANLG
HEADER	ON
LIGHT	ON
NAME	(last set value)
PRN	IBM
TIME	Time since power-on in seconds
VERBOSE	ON

## Measurement Commands

FORMAT	ASCII
FUNCTION	LEVEL
SDELAY	7.5E-2
SETTLE	OFF
SPOINTS	3
SRESOLUTION	1.E-7
STIMEOUT	5.
STOLERANCE	1.
SWEEP	STOP
TRIGGER	OFF

## Analog Generator Commands

GAMPLITUDE	1. V
GFREQUENCY	1.E+3 HZ
GZ	B40
IMDHF	7000.
IMDLF	60.
OUTPUT	OFF
WAVEFORM	SINE

## Analog Analyzer Commands

INPUT	A
REFDBM	600. OHM
REFDBR	1. V
REFWATT	8. OHM
RNGA	-0.1
RNGB	-0.1
RNGM	1.
ZINA	HIGH
ZINB	HIGH

<b>ACMAINS:</b>	
LUNIT	PCT
MMAX	300. V
MMIN	0. V
UNIT	V

<b>AMPLITUDE:</b>	
AMAX	1 V
AMIN	0 V
BPFR	1. E+3 HZ
EXTERNAL	GLIDE
FILTER	UNWTD
FMAX	20. E+3 HZ
FMIN	20. HZ
HPASS	OFF
LPASS	R300K
MMAX	10. V
MMIN	1. E-6 V
SPEED	FAST
STEPS	0
SWPTYPE	FREQ
UNIT	V
WTD	IECA

<b>GENLOAD:</b>	
FMAX	20. E+3 HZ
FMIN	20. HZ
MMAX	1000. OHM
MMIN	0. OHM
SPEED	FAST
STEPS	0
UNIT	OHM

<b>IMD:</b>	
AMAX	1. V
AMIN	0. V
LUNIT	V
MMAX	1. PCT
MMIN	0. PCT
SPEED	FAST
STEPS	0
UNIT	PCT

<b>LEVEL:</b>	
AMAX	1. V
AMIN	0. V
EXTERNAL	GLIDE
FMAX	20. E+3 HZ
FMIN	20. HZ
LUNIT	V

<b>LEVEL:</b>	
MMAX	10. V
MMIN	1. E-6 V
SPEED	FAST
STEPS	0
SWPTYPE	FREQ
UNIT	V

<b>NOISE:</b>	
AMAX	1. V
AMIN	0. V
BPFR	1. E+3 HZ
EXTERNAL	GLIDE
FILTER	UNWTD
FMAX	20. E+3 HZ
FMIN	20. HZ
HPASS	OFF
LPASS	R80K
MMAX	10. V
MMIN	1. E-6 V
SPEED	FAST
STEPS	0
SWPTYPE	FREQ
UNIT	V
WTD	IECA

<b>PHASE:</b>	
AMAX	1. V
AMIN	0. V
AVERAGE	NOAVERAGE
EXTERNAL	GLIDE
FMAX	20. E+3 HZ
FMIN	20. HZ
LUNIT	V
MMAX	180. DEG
MMIN	-180. DEG
RANGE	DEG270
SPEED	FAST
STEPS	0
SWPTYPE	FREQ
UNIT	DEG

<b>RATIO:</b>	
AMAX	1. V
AMIN	0. V
EXTERNAL	GLIDE
FMAX	20. E+3 HZ
FMIN	20. HZ
LUNIT	V
MMAX	20. DB
MMIN	-60. DB
MODE	1
SPEED	FAST
STEPS	0
SWPTYPE	FREQ
UNIT	DB

<b>SINAD:</b>	
HPASS	OFF
LPASS	R30K
LUNIT	V
MMAX	40. DB
MMIN	-140. DB
NOTCHFREQ	400. HZ
PRESET	F400
TUNE	OFF
UNIT	DB

<b>THD:</b>	
AMAX	1. V
AMIN	0. V
EXTERNAL	GLIDE
FILTER	UNWTD
FMAX	20. E+3 HZ
FMIN	20. HZ
HPASS	OFF
LPASS	R80K
LUNIT	V
MMAX	1. PCT
MMIN	0.0001 PCT
NOTCHFREQ	1. E+3 HZ
SPEED	FAST
STEPS	0
SWPTYPE	FREQ
TUNE	AUTO
UNIT	PCT
WTD	RMSCCIR

<b>WF:</b>	
DETECTOR	IEC
FILTER	WTD
LUNIT	V
MMAX	1. PCT
MMIN	0. PCT
RESPONSE	PEAK
UNIT	PCT
WFUNIT	HZ

<b>XTALK:</b>	
AMAX	1. V
AMIN	0. V
EXTERNAL	GLIDE
FMAX	20. E+3 HZ
FMIN	20. HZ
LUNIT	V
MMAX	0. DB
MMIN	-120. DB
SPEED	FAST
STEPS	0
SWPTYPE	FREQ
UNIT	DB

## Digital Generator Commands (*P1DD*)

DCAL	BAL
DGAMPLITUDE	0. DBFS
DGFREQUENCY	997. HZ
DGRATE	48000. HZ
DGSQRFREQ	1000. HZ
DIMHF	7000.
DIMLF	60.
DITHER	TRI
DOAMPLITUDE	5. VPP
DORESOLUTION	24
DOUTPUT	OFF
DSREF	OFF
DSYNCH	0.
DWAVEFORM	SINE
JAMPLITUDE	0. UI
JFREQUENCY	1.002 E+3 HZ
JWAVE	OFF

# Digital Analyzer Commands (P1DD)

DHOLD	OFF
DINPUT	A
DREFDBR	1. FFS
DRGA	-90.309
DRGB	-90.309
DZIN	HIGH

<b>DAMPLITUDE:</b>	
AMAX	1. V
AMIN	0. V
BPFR	1. E+3
EXTERNAL	GLIDE
FILTER	UNWTD
FMAX	20. E+3 HZ
FMIN	20. HZ
HPASS	HP10
LPASS	HALFRATE
MMAX	0. DBFS
MMIN	-120. DBFS
SPEED	FAST
STEPS	0
SWPTYPE	FREQ
UNIT	DBFS
WTD	IECA

<b>DCHK:</b>	
DBITS	ACTV
DUNIT	HEX
MMAX	1000 NORM
MMIN	0 NORM
UNIT	NORM

<b>DIMD:</b>	
AMAX	1. V
AMIN	0. V
LUNIT	DBFS
MMAX	-40. DB
MMIN	-999. DB
SPEED	FAST
STEPS	0
UNIT	DB

<b>DIO:</b>	
DDREF	OUTF
DIREOLUTION	0.
DUNIT	SEC
FRQREF	MEAS
MMAX	50000. HZ
MMIN	30000. HZ
UNIT	HZ

<b>DJITTER:</b>	
AMAX	1. V
AMIN	0. V
BPFR	1. E+3 HZ
EXTERNAL	GLIDE
FILTER	UNWTD
FMAX	20. E+3 HZ
FMIN	20. HZ
HPASS	HP50
JDETECTOR	RMS
LUNIT	VPP
MMAX	1. UI
MMIN	0. UI
SPEED	FAST
STEPS	0
SWPTYPE	FREQ
UNIT	UI

<b>DLEVEL:</b>	
AMAX	1. V
AMIN	0. V
EXTERNAL	GLIDE
FMAX	20. E+3 HZ
FMIN	20. HZ
LUNIT	DBFS
MMAX	0. DBFS
MMIN	-120. DBFS
SPEED	FAST
STEPS	0
SWPTYPE	FREQ
UNIT	DBFS

<b>DNOISE:</b>	
AMAX	1. V
AMIN	0. V
BPFR	1. E+3 HZ
EXTERNAL	GLIDE
FILTER	UNWTD
FMAX	20. E+3 HZ
FMIN	20. HZ
HPASS	HP10
LPASS	HALFRATE
MMAX	0. DBFS
MMIN	-120. DBFS
SPEED	FAST
STEPS	0
SWPTYPE	FREQ
UNIT	DBFS
WTD	IECA

<b>DPHASE:</b>	
AMAX	1. V
AMIN	0. V
EXTERNAL	GLIDE
FMAX	20. E+3 HZ
FMIN	20. HZ
LUNIT	DBFS
MMAX	180. DEG
MMIN	-180. DEG
RANGE	DEG270
SPEED	FAST
STEPS	0
SWPTYPE	FREQ
UNIT	DEG

<b>DRATIO:</b>	
AMAX	1. V
AMIN	0. V
EXTERNAL	GLIDE
FMAX	20. E+3 HZ
FMIN	20. HZ
LUNIT	DBFS
MMAX	20. DB
MMIN	-60. DB
SPEED	FAST
STEPS	0
SWPTYPE	FREQ
UNIT	DB

<b>DTHD:</b>	
AMAX	1. V
AMIN	0. V
EXTERNAL	GLIDE
FILTER	UNWTD
FMAX	20. E+3 HZ
FMIN	20. HZ
HPASS	HP10
LPASS	HALFRATE
LUNIT	DBFS
MMAX	-40. DB
MMIN	-120. DB
NOTCHFREQ	1.E+3 HZ
SPEED	FAST
STEPS	0
SWPTYPE	FREQ
TUNE	AUTO
UNIT	DB
WTD	IECA

<b>DXTALK:</b>	
AMAX	1. V
AMIN	0. V
EXTERNAL	GLIDE
FMAX	20. E+3 HZ
FMIN	20. HZ
LUNIT	DBFS
MMAX	0. DB
MMIN	-120. DB
SPEED	FAST
STEPS	0
SWPTYPE	FREQ
UNIT	DB

## Digital Output Status Commands (P1DD)

<b>DOSTATUS:</b>	
CONS	AUTO, NONE, NO
PROF	AUTO, NI, NULL, NULL
STDO	PROF
VALIDITY	VALID



# Index

- \*CLS, 2-1
- \*ESE, 2-1
- \*ESE?, 2-1
- \*ESR?, 2-2
- \*IDN?, 2-2
- \*LRN?, 2-2
- \*OPC, 2-6
- \*OPC, Using, 1-15
- \*OPC?, 2-6
- \*OPC?, using, 1-16
- \*OPT?, 2-6
- \*RCL, 2-7
- \*RST, 2-7
- \*SAV, 2-7
- \*SRE, 2-8
- \*SRE?, 2-8
- \*STB?, 2-8
- \*TRG, 2-8
- \*TST?, 2-9
- \*WAI, 2-9
- ACMains:, 5-6
- ACMains:LUNit, 5-6
- ACMains:LUNit?, 5-6
- ACMains:MMAX, 5-6
- ACMains:MMAX?, 5-6
- ACMains:MMIN, 5-6
- ACMains:MMIN?, 5-7
- ACMains:SET?, 5-7
- ACMains:UNIT, 5-7
- ACMains:UNIT?, 5-7
- Amplitude Sweeps, 1-23
- AMPLitude:, 5-8
- AMPLitude:AMAX, 5-8
- AMPLitude:AMAX?, 5-8
- AMPLitude:AMIN, 5-8
- AMPLitude:AMIN?, 5-9
- AMPLitude:BPFR, 5-9
- AMPLitude:BPFR?, 5-9
- AMPLitude:EXtErnal, 5-10
- AMPLitude:EXtErnal?, 5-10
- AMPLitude:FiLTer, 5-10
- AMPLitude:FiLTer?, 5-10
- AMPLitude:FMAX, 5-10
- AMPLitude:FMAX?, 5-11
- AMPLitude:FMIN, 5-11
- AMPLitude:FMIN?, 5-11
- AMPLitude:HPASs, 5-11
- AMPLitude:HPASs?, 5-11
- AMPLitude:LPASs, 5-12
- AMPLitude:LPASs?, 5-12
- AMPLitude:MMAx, 5-12
- AMPLitude:MMAx?, 5-12
- AMPLitude:MMIN, 5-12
- AMPLitude:MMIN?, 5-13
- AMPLitude:SEt?, 5-13
- AMPLitude:SPeEd, 5-13
- AMPLitude:SPeEd?, 5-13
- AMPLitude:StEPs, 5-13
- AMPLitude:StEPs?, 5-14
- AMPLitude:SWPtYpe, 5-14
- AMPLitude:SWPtYpe?, 5-14
- AMPLitude:UNIt, 5-15
- AMPLitude:UNIt?, 5-15
- AMPLitude:WTD, 5-15
- AMPLitude:WTD?, 5-15
- Analog Analyzer commands, 5-1
- Analog Analyzer Commands (list), 1-27
- Analog Audio Functions, 1-1
- Analog Generator commands, 4-1, 6-1, 7-1
- Analog Generator Commands (list), 26
- Analyzer Function-Setting Commands, 1-28
- ASCII code chart, 1-4
- CLROutbuf, 2-9
- CLRTIME, 2-9
- Command Error, 1-10
- command groups, 4-1, 6-1, 7-1
- Command Groups, 1-26
- command notation and syntax, 4-1, 6-1, 7-1
- common commands, 1-7
- compound command headers, 1-6
- concatenated message units, 1-7
- DAMPlitude:, 7-5
- DAMPlitude:AMAX, 7-5
- DAMPlitude:AMAX?, 7-5
- DAMPlitude:AMIN, 7-5
- DAMPlitude:AMIN?, 7-6
- DAMPlitude:BPFR, 7-6
- DAMPlitude:BPFR?, 7-6
- DAMPlitude:EXtErnal, 7-7
- DAMPlitude:EXtErnal?, 7-7
- DAMPlitude:FiLTer, 7-7
- DAMPlitude:FiLTer?, 7-7
- DAMPlitude:FMAX, 7-7
- DAMPlitude:FMAX?, 7-8
- DAMPlitude:FMIN, 7-8
- DAMPlitude:FMIN?, 7-8
- DAMPlitude:HPASs, 7-8
- DAMPlitude:HPASs?, 7-8
- DAMPlitude:LPASs, 7-9
- DAMPlitude:LPASs?, 7-9
- DAMPlitude:MMAx, 7-9
- DAMPlitude:MMAx?, 7-9
- DAMPlitude:MMIN, 7-9
- DAMPlitude:MMIN?, 7-10
- DAMPlitude:SEt?, 7-10
- DAMPlitude:SPeEd, 7-10
- DAMPlitude:SPeEd?, 7-10
- DAMPlitude:StEPs, 7-11
- DAMPlitude:StEPs?, 7-11
- DAMPlitude:SWPtYpe, 7-11
- DAMPlitude:SWPtYpe?, 7-12
- DAMPlitude:UNIt, 7-12
- DAMPlitude:UNIt?, 7-12
- DAMPlitude:WTD, 7-12
- DAMPlitude:WTD?, 7-12
- DATA1?, 3-1
- DATA2?, 3-2
- DATAA?, 3-2
- DATAF?, 3-2
- DATE, 2-10
- DATE?, 2-10
- DBRZero, 3-3
- DCAL, 6-1
- DCAL?, 6-1
- DCHK:, 7-13
- DCHK:BITs?, 7-13
- DCHK:DBITs, 7-13
- DCHK:DBITs?, 7-14
- DCHK:DUNit, 7-14
- DCHK:DUNit?, 7-14
- DCHK:MMAx, 7-14
- DCHK:MMAx?, 7-14
- DCHK:MMIN, 7-15
- DCHK:MMIN?, 7-15
- DCHK:SEt?, 7-15
- DCHK:UNIt, 7-15
- DCHK:UNIt?, 7-15
- Deadlocks, 1-6
- DELAy, 2-10
- Delayed Query Responses, 1-6
- DELEte, 2-10
- DELEte?, 2-11
- Delimiters, 1-5
- Device Error, 1-10
- DGAMplitude, 6-1
- DGAMplitude?, 6-1
- DGFRequency, 6-2
- DGFRequency?, 6-2
- DGRate, 6-2
- DGRate?, 6-2
- DGSQrfreq, 6-3
- DGSQrfreq?, 6-3
- DHOLd, 7-1
- DHOLd?, 7-1
- Digital Analyzer Commands (list), 27
- Digital Audio Functions, 1-1
- Digital Generator Commands (list), 1-27

- Digital Input Status and Error
  - Commands (list), 1-28
- Digital Input Status commands, 9-1
- Digital Output Status
  - Commands (list), 1-27
- DIMD:, 7-16
- DIMD:AMAX, 7-16
- DIMD:AMAX?, 7-16
- DIMD:AMIN, 7-17
- DIMD:AMIN?, 7-17
- DIMD:LUNit, 7-17
- DIMD:LUNit?, 7-18
- DIMD:MMAx, 7-18
- DIMD:MMAx?, 7-18
- DIMD:MMIN, 7-18
- DIMD:MMIN?, 7-18
- DIMD:SET?, 7-19
- DIMD:SPEed, 7-19
- DIMD:SPEed?, 7-19
- DIMD:STEPS, 7-19
- DIMD:STEPS?, 7-19
- DIMD:UNIT, 7-20
- DIMD:UNIT?, 7-20
- DIMHf, 6-3
- DIMHf?, 6-4
- DIMLf, 6-4
- DIMLf?, 6-4
- DINPut, 7-1
- DINPut?, 7-2
- DIO:, 7-21
- DIO:DIResolution, 7-21
- DIO:DIResolution?, 7-22
- DIO:DREF, 7-21
- DIO:DREF?, 7-21
- DIO:DUNit, 7-22
- DIO:DUNit?, 7-22
- DIO:FRQRef, 7-22
- DIO:FRQRef?, 7-22
- DIO:MMAx, 7-23
- DIO:MMAx?, 7-23
- DIO:MMIN, 7-23
- DIO:MMIN?, 7-23
- DIO:SET?, 7-24
- DIO:UNIT, 7-24
- DIO:UNIT?, 7-24
- DISPlay, 2-11
- DISPlay?, 2-11
- DISTatus:, 9-1
- DISTatus:CODing?, 9-1
- DISTatus:CONFidence?, 9-1
- DISTatus:ERRor?, 9-1
- DISTatus:INValid?, 9-2
- DISTatus:LOCK?, 9-2
- DISTatus:PARity?, 9-2
- DISTatus:STATus?, 9-2
- DISTatus:STDI?, 9-3
- DITHer, 6-4
- DITHer?, 6-5
- DJITter:, 7-25
- DJITter:AMAX, 7-25
- DJITter:AMAX?, 7-25
- DJITter:AMIN, 7-26
- DJITter:BPFR, 7-26
- DJITter:BPFR?, 7-27
- DJITter:DETEctor, 7-29
- DJITter:DETEctor?, 7-29
- DJITter:EXTernal, 7-27
- DJITter:EXTernal?, 7-27
- DJITter:FILTer, 7-27
- DJITter:FILTer?, 7-27
- DJITter:FMAx, 7-28
- DJITter:FMAx?, 7-28
- DJITter:FMIN, 7-28
- DJITter:FMIN?, 7-28
- DJITter:HPASs, 7-28
- DJITter:HPASs?, 7-29
- DJITter:MMAx, 7-29
- DJITter:MMAx?, 7-29
- DJITter:MMIN, 7-30
- DJITter:MMIN?, 7-30
- DJITter:SET?, 7-30
- DJITter:SPEed, 7-30
- DJITter:SPEed?, 7-31
- DJITter:STEPS, 7-31
- DJITter:STEPS?, 7-31
- DJITter:SWPType, 7-31
- DJITter:SWPType?, 7-32
- DJITter:UNIT, 7-32
- DJITter:UNIT?, 7-32
- DLEVel:, 7-33
- DLEVel:AMAX, 7-33
- DLEVel:AMAX?, 7-33
- DLEVel:AMIN, 7-34
- DLEVel:AMIN?, 7-34
- DLEVel:EXTernal, 7-34
- DLEVel:EXTernal?, 7-35
- DLEVel:FMAx, 7-35
- DLEVel:FMAx?, 7-35
- DLEVel:FMIN, 7-35
- DLEVel:FMIN?, 7-35
- DLEVel:LUNit, 7-36
- DLEVel:LUNit?, 7-36
- DLEVel:MMAx, 7-36
- DLEVel:MMAx?, 7-36
- DLEVel:MMIN, 7-36
- DLEVel:MMIN?, 7-37
- DLEVel:SET?, 7-37
- DLEVel:SPEed, 7-37
- DLEVel:SPEed?, 7-37
- DLEVel:STEPS, 7-38
- DLEVel:STEPS?, 7-38
- DLEVel:SWPType, 7-38
- DLEVel:SWPType?, 7-39
- DLEVel:UNIT, 7-39
- DLEVel:UNIT?, 7-39
- DNOise:, 7-40
- DNOise:AMAX, 7-40
- DNOise:AMAX?, 7-40
- DNOise:AMIN, 7-40
- DNOise:AMIN?, 7-41
- DNOise:BPFR, 7-41
- DNOise:BPFR?, 7-41
- DNOise:EXTernal, 7-42
- DNOise:EXTernal?, 7-42
- DNOise:FILTer, 7-42
- DNOise:FILTer?, 7-42
- DNOise:FMAx, 7-42
- DNOise:FMAx?, 7-43
- DNOise:FMIN, 7-43
- DNOise:FMIN?, 7-43
- DNOise:HPASs, 7-43
- DNOise:HPASs?, 7-43
- DNOise:LPASs, 7-44
- DNOise:LPASs?, 7-44
- DNOise:MMAx, 7-44
- DNOise:MMAx?, 7-44
- DNOise:MMIN, 7-45
- DNOise:MMIN?, 7-45
- DNOise:SET?, 7-45
- DNOise:SPEed, 7-45
- DNOise:SPEed?, 7-46
- DNOise:STEPS, 7-46
- DNOise:STEPS?, 7-46
- DNOise:SWPType, 7-46
- DNOise:SWPType?, 7-47
- DNOise:UNIT, 7-47
- DNOise:UNIT?, 7-47
- DNOise:WTD, 7-47
- DNOise:WTD?, 7-47
- DOAMplitude, 6-5
- DOAMplitude?, 6-5
- DOResolution, 6-6
- DOResolution?, 6-6
- DOSTatus:, 8-1
- DOSTatus:CONS, 8-2
- DOSTatus:CONS?, 8-3
- DOSTatus:PROF, 8-3
- DOSTatus:PROF?, 8-4
- DOSTatus:SET?, 8-4
- DOSTatus:STDO, 8-4
- DOSTatus:STDO?, 8-5
- DOSTatus:VALidity, 8-5
- DOSTatus:VALidity?, 8-5
- DOUTput, 6-6
- DOUTput?, 6-7
- DPHase:, 7-48
- DPHase:AMAX, 7-48
- DPHase:AMAX?, 7-48
- DPHase:AMIN, 7-49
- DPHase:AMIN?, 7-49
- DPHase:EXTernal, 7-49
- DPHase:EXTernal?, 7-50
- DPHase:FMAx, 7-50
- DPHase:FMAx?, 7-50
- DPHase:FMIN, 7-50
- DPHase:FMIN?, 7-50
- DPHase:LUNit, 7-51
- DPHase:LUNit?, 7-51
- DPHase:MMAx, 7-51
- DPHase:MMAx?, 7-51
- DPHase:MMIN, 7-51
- DPHase:MMIN?, 7-52
- DPHase:RANGe, 7-52
- DPHase:RANGe?, 7-52
- DPHase:SET?, 7-52
- DPHase:SPEed, 7-53
- DPHase:STEPS, 7-53

- DPHase:STEPS?, 7-53  
 DPHase:SWPTtype, 7-54  
 DPHase:SWPTtype?, 7-54  
 DPHase:UNIT, 7-54  
 DPHase:UNIT?, 7-54  
 DRATio:, 7-55  
 DRATio:AMAX, 7-55  
 DRATio:AMAX?, 7-55  
 DRATio:AMIN, 7-55  
 DRATio:AMIN?, 7-56  
 DRATio:EXTErnal, 7-56  
 DRATio:EXTErnal?, 7-56  
 DRATio:FMAX, 7-57  
 DRATio:FMAX?, 7-57  
 DRATio:FMIN, 7-57  
 DRATio:FMIN?, 7-57  
 DRATio:LUNit, 7-57  
 DRATio:LUNit?, 7-58  
 DRATio:MMAx, 7-58  
 DRATio:MMAx?, 7-58  
 DRATio:MMIN, 7-58  
 DRATio:MMIN?, 7-58  
 DRATio:SET?, 7-59  
 DRATio:SPEEd, 7-59  
 DRATio:SPEEd?, 7-59  
 DRATio:STEPS, 7-59  
 DRATio:STEPS?, 7-60  
 DRATio:SWPTtype, 7-60  
 DRATio:SWPTtype?, 7-60  
 DRATio:UNIT, 7-60  
 DRATio:UNIT?, 7-60  
 DREFdbr, 7-3  
 DREFdbr?, 7-3  
 DRGA, 7-3  
 DRGA?, 7-3  
 DRGB, 7-4  
 DRGB?, 7-4  
 DSRef, 6-7  
 DSRef?, 6-7  
 DSYNch, 6-8  
 DSYNch?, 6-8  
 DTHD:, 7-61  
 DTHD:AMAX, 7-61  
 DTHD:AMAX?, 7-61  
 DTHD:AMIN, 7-62  
 DTHD:AMIN?, 7-62  
 DTHD:EXTErnal, 7-62  
 DTHD:EXTErnal?, 7-63  
 DTHD:FILTEr, 7-63  
 DTHD:FILTEr?, 7-63  
 DTHD:FMAX, 7-63  
 DTHD:FMAX?, 7-63  
 DTHD:FMIN, 7-64  
 DTHD:FMIN?, 7-64  
 DTHD:HPASs, 7-64  
 DTHD:HPASs?, 7-64  
 DTHD:LPASs, 7-64  
 DTHD:LPASs?, 7-65  
 DTHD:LUNit, 7-65  
 DTHD:LUNit?, 7-65  
 DTHD:MMAx, 7-65  
 DTHD:MMAx?, 7-65  
 DTHD:MMIN, 7-66  
 DTHD:MMIN?, 7-66  
 DTHD:NOTChfreq, 7-66  
 DTHD:NOTChfreq?, 7-66  
 DTHD:SET?, 7-67  
 DTHD:SPEEd, 7-67  
 DTHD:SPEEd?, 7-67  
 DTHD:STEPS, 7-67  
 DTHD:STEPS?, 7-68  
 DTHD:SWPTtype, 7-68  
 DTHD:SWPTtype?, 7-68  
 DTHD:TUNe, 7-68  
 DTHD:TUNe?, 7-69  
 DTHD:UNIT, 7-69  
 DTHD:UNIT?, 7-69  
 DTHD:WTD, 7-69  
 DTHD:WTD?, 7-69  
 DTIme, 2-12  
 DTIme?, 2-12  
 DTRGout, 2-12  
 DTRGout?, 2-13  
 DWAVEform, 6-8  
 DWAVEform?, 6-9  
 DXTalk:, 7-70  
 DXTalk:AMAX, 7-70  
 DXTalk:AMAX?, 7-70  
 DXTalk:AMIN, 7-70  
 DXTalk:AMIN?, 7-71  
 DXTalk:EXTErnal, 7-71  
 DXTalk:EXTErnal?, 7-71  
 DXTalk:FMAX, 7-72  
 DXTalk:FMAX?, 7-72  
 DXTalk:FMIN, 7-72  
 DXTalk:FMIN?, 7-72  
 DXTalk:LUNit, 7-72  
 DXTalk:LUNit?, 7-73  
 DXTalk:MMAx, 7-73  
 DXTalk:MMAx?, 7-73  
 DXTalk:MMIN, 7-73  
 DXTalk:MMIN?, 7-73  
 DXTalk:SET?, 7-74  
 DXTalk:SPEEd, 7-74  
 DXTalk:SPEEd?, 7-74  
 DXTalk:STEPS, 7-74  
 DXTalk:STEPS?, 7-75  
 DXTalk:SWPTtype, 7-75  
 DXTalk:SWPTtype?, 7-75  
 DXTalk:UNIT, 7-75  
 DXTalk:UNIT?, 7-75  
 DZIN, 7-4  
 DZIN?, 7-4  
 Enable Registers, 1-11  
 EOI message terminator, 1-4  
 ERRMessage?, 2-13  
 Error Codes and Error Messages, 1-14  
 Error Messages Table, 1-14  
 ESB (Event Status Bit), 1-11  
 Event Handling Sequence, 1-12  
 Event Status Enable Register (ESER), 1-12  
 Execution Error, 1-10  
 Factory Default Settings, 1-29  
 FORMat, 3-3  
 FORMat?, 3-3  
 Frequency Sweeps, 1-23  
 FUNCTioN, 3-4  
 FUNCTioN?, 3-4  
 GAMPlitude, 4-1  
 GAMPlitude?, 4-1  
 General Purpose Interface Bus (GPIB), 1-2  
 GENerator, 2-13  
 GENerator?, 2-13  
 GENLoad, 5-16  
 GENLoad:FMAX, 5-16  
 GENLoad:FMAX?, 5-16  
 GENLoad:FMIN, 5-16  
 GENLoad:FMIN?, 5-16  
 GENLoad:MMAx, 5-17  
 GENLoad:MMAx?, 5-17  
 GENLoad:MMIN, 5-17  
 GENLoad:MMIN?, 5-17  
 GENLoad:SET?, 5-17  
 GENLoad:SPEEd, 5-18  
 GENLoad:SPEEd?, 5-18  
 GENLoad:STEPS, 5-18  
 GENLoad:STEPS?, 5-18  
 GENLoad:UNIT, 5-18  
 GENLoad:UNIT?, 5-19  
 GFREquency, 4-1  
 GFREquency?, 4-1  
 GPIB address, 1-2, 1-3, 1-4, 1-29  
 GPIB interface functions, 1-9  
 GPIB Sample Program, 1-30, 1-31  
 GPIB Status and Event Reporting, 1-9  
 GZ, 4-2  
 GZ?, 4-2  
 HEADer, 2-14  
 HEADer?, 2-14  
 HELP?, 2-14  
 HOLD, 5-1  
 IEEE Std 488, 1-2, 1-10  
 IMD:, 5-20  
 IMD:AMAX, 5-20  
 IMD:AMAX?, 5-20  
 IMD:AMIN, 5-20  
 IMD:AMIN?, 5-21  
 IMD:LUNit, 5-21  
 IMD:LUNit?, 5-21  
 IMD:MMAx, 5-22  
 IMD:MMAx?, 5-22  
 IMD:MMIN, 5-22  
 IMD:MMIN?, 5-22  
 IMD:SET?, 5-23  
 IMD:SPEEd, 5-23  
 IMD:SPEEd?, 5-23  
 IMD:STEPS, 5-23  
 IMD:STEPS?, 5-24  
 IMD:UNIT, 5-24  
 IMD:UNIT?, 5-24  
 IMDHf, 4-2  
 IMDHf?, 4-2

- IMDLf, 4-3
- IMDLf?, 4-3
- Improving Performance, 1-25
- INPut, 5-1
- INPut?, 5-1
- JAMPlitude, 6-9
- JAMPlitude?, 6-9
- JFRequency, 6-9
- JFRequency?, 6-10
- JWAVeform, 6-10
- JWAVeform?, 6-10
- LEVel:, 5-25
- LEVel:AMAX, 5-25
- LEVel:AMAX?, 5-25
- LEVel:AMIN, 5-26
- LEVel:AMIN?, 5-26
- LEVel:EXTErnal, 5-26
- LEVel:EXTErnal?, 5-27
- LEVel:FMAX, 5-27
- LEVel:FMAX?, 5-27
- LEVel:FMIN, 5-27
- LEVel:FMIN?, 5-27
- LEVel:LUNit, 5-28
- LEVel:LUNit?, 5-28
- LEVel:MMAx, 5-28
- LEVel:MMAx?, 5-28
- LEVel:MMIN, 5-28
- LEVel:MMIN?, 5-29
- LEVel:SEt?, 5-29
- LEVel:SPeEd, 5-29
- LEVel:SPeEd?, 5-29
- LEVel:SEtPs, 5-30
- LEVel:SEtPs?, 5-30
- LEVel:SWPType, 5-30
- LEVel:SWPType?, 5-30
- LEVel:UNIT, 5-31
- LEVel:UNIT?, 5-31
- LIGHT, 2-18
- LIGHT?, 2-18
- M1?, 3-4
- M2?, 3-5
- M3?, 3-6
- MAV (Message Available), 1-11
- MAV bit (Message AVailable), using, 1-16
- Measurement Acquisition, 1-18
- Measurement commands, 3-1, 8-1, 9-1
- Measurement Commands (list), 1-26
- measurements, 1-16
- message terminator, 1-3, 1-4
- message unit, 1-5
- message unit header, 1-6
- MF?, 3-7
- Mnemonic, 1-8
- MP?, 3-7
- MSS (Master Summary Status), 1-11
- NAME, 2-18
- NAME?, 2-19
- NOISe:, 5-32
- NOISe:AMAX, 5-32
- NOISe:AMAX?, 5-32
- NOISe:AMIN, 5-33
- NOISe:AMIN?, 5-33
- NOISe:BPFR, 5-33
- NOISe:BPFR?, 5-34
- NOISe:EXTErnal, 5-34
- NOISe:EXTErnal?, 5-34
- NOISe:FiLTER, 5-34
- NOISe:FiLTER?, 5-34
- NOISe:FMAX, 5-35
- NOISe:FMAX?, 5-35
- NOISe:FMIN, 5-35
- NOISe:FMIN?, 5-35
- NOISe:HPASs, 5-35
- NOISe:HPASs?, 5-36
- NOISe:LPASs, 5-36
- NOISe:LPASs?, 5-36
- NOISe:MMAx, 5-36
- NOISe:MMAx?, 5-36
- NOISe:MMIN, 5-37
- NOISe:MMIN?, 5-37
- NOISe:SEt?, 5-37
- NOISe:SPeEd, 5-37
- NOISe:SPeEd?, 5-38
- NOISe:SEtPs, 5-38
- NOISe:SEtPs?, 5-38
- NOISe:SWPType, 5-38
- NOISe:SWPType?, 5-39
- NOISe:UNIT, 5-39
- NOISe:UNIT?, 5-39
- NOISe:WTD, 5-39
- NOISe:WTD?, 5-39
- Operation Complete, 1-10
- OUTPut, 4-3
- OUTPut?, 4-3
- Overview, 1-1
- PHASe:, 5-40
- PHASe:AMAX, 5-40
- PHASe:AMAX?, 5-40
- PHASe:AMIN, 5-40
- PHASe:AMIN?, 5-41
- PHASe:AVERAge, 5-41
- PHASe:AVERAge?, 5-41
- PHASe:EXTErnal, 5-42
- PHASe:EXTErnal?, 5-42
- PHASe:FMAX, 5-42
- PHASe:FMAX?, 5-42
- PHASe:FMIN, 5-42
- PHASe:FMIN?, 5-43
- PHASe:LUNit, 5-43
- PHASe:LUNit?, 5-43
- PHASe:MMAx, 5-43
- PHASe:MMAx?, 5-43
- PHASe:MMIN, 5-44
- PHASe:MMIN?, 5-44
- PHASe:RANGe, 5-44
- PHASe:RANGe?, 5-44
- PHASe:SEt?, 5-44
- PHASe:SEt?, 5-44
- PHASe:SPeEd, 5-45
- PHASe:SEtPs, 5-45
- PHASe:SEtPs?, 5-45
- PHASe:SWPType, 5-46
- PHASe:SWPType?, 5-46
- PHASe:UNIT, 5-46
- PHASe:UNIT?, 5-46
- Power On, 1-10
- PRINt, 2-19
- PRN, 2-19
- PRN?, 2-19
- PROTEct, 2-20
- PROTEct?, 2-20
- queries, 1-5
- Query Error, 1-10
- query responses without headers, 1-6
- RATio:, 5-47
- RATio:AMAX, 5-47
- RATio:AMAX?, 5-47
- RATio:AMIN, 5-48
- RATio:AMIN?, 5-48
- RATio:EXTErnal, 5-48
- RATio:EXTErnal?, 5-49
- RATio:FMAX, 5-49
- RATio:FMAX?, 5-49
- RATio:FMIN, 5-49
- RATio:FMIN?, 5-49
- RATio:LUNit, 5-50
- RATio:LUNit?, 5-50
- RATio:MMAx, 5-50
- RATio:MMAx?, 5-50
- RATio:MMIN, 5-50
- RATio:MMIN?, 5-51
- RATio:MODE, 5-51
- RATio:MODE?, 5-51
- RATio:SEt?, 5-51
- RATio:SPeEd, 5-52
- RATio:SPeEd?, 5-52
- RATio:SEtPs, 5-52
- RATio:SEtPs?, 5-52
- RATio:SWPType, 5-53
- RATio:SWPType?, 5-53
- RATio:UNIT, 5-53
- RATio:UNIT?, 5-53
- REFDBM, 5-2
- REFDBM?, 5-2
- REFDBR, 5-2
- REFDBR?, 5-2
- REFWatt, 5-2
- REFWatt?, 5-3
- REPEat, 3-7
- Reset Settings, 1-29
- RNGA, 5-3
- RNGA?, 5-3
- RNGB, 5-3
- RNGB?, 5-4
- RNGM, 5-4
- RNGM?, 5-4
- RQS (Request Service), 1-11
- SDELay, 3-8
- SDELay?, 3-8
- Serial Poll, 1-11
- Serial Poll Method, 1-15
- Service Request Enable Register (SRER), 1-12
- Service Request Method, 1-15

- SET?, 2-20
- Settings Recall Sample Program, 1-37
- Settings Save Sample Program, 1-43
- SETtle, 3-8
- SETtle?, 3-8
- settled measurements, 1-18
- settling parameters, 1-18
- Signal to Noise (S/N) Ratio, 5-39
- SINad:, 5-54
- SINad:HPASs, 5-54
- SINad:HPASs?, 5-54
- SINad:LPASs, 5-54
- SINad:LPASs?, 5-54
- SINad:LUNit, 5-54
- SINad:LUNit?, 5-55
- SINad:MMAx, 5-55
- SINad:MMAx?, 5-55
- SINad:MMIN, 5-55
- SINad:MMIN?, 5-55
- SINad:NOTChfreq, 5-56
- SINad:NOTChfreq?, 5-56
- SINad:PRESet, 5-56
- SINad:PRESet?, 5-57
- SINad:SET?, 5-56
- SINad:TUNe, 5-57
- SINad:TUNe?, 5-57
- SINad:UNIT, 5-57
- SINad:UNIT?, 5-57
- SPOints, 3-9
- SPOints?, 3-9
- SRESolution, 3-9
- SRESolution?, 3-9
- Standard Event Status Register (SESR), 1-10
- Status and Event handling process, 1-13
- Status Byte Register (SBR), 1-11
- Status Registers, 1-10
- STIMEout, 3-9
- STIMEout?, 3-10
- STOLerance, 3-10
- STOLerance?, 3-10
- Suffixes, 1-8
- SWEep, 3-10
- SWEep?, 3-11
- Sweeps
  - Amplitude, 1-23
  - Frequency, 1-23
- Synchronization Methods, 1-15
- Syntax Notation, 1-4
- System commands, 2-1
- System Commands list, 1-26
- Terse Query Responses, 1-6
- TEST, 2-22
- THD:, 5-58
- THD:AMAX, 5-58
- THD:AMAX?, 5-58
- THD:AMIN, 5-59
- THD:AMIN?, 5-59
- THD:EXternal, 5-59
- THD:EXternal?, 5-60
- THD:FILTer, 5-60
- THD:FILTer?, 5-60
- THD:FMAX, 5-60
- THD:FMAX?, 5-60
- THD:FMIN, 5-61
- THD:FMIN?, 5-61
- THD:HPASs, 5-61
- THD:HPASs?, 5-61
- THD:LPASs, 5-61
- THD:LPASs?, 5-62
- THD:LUNit, 5-62
- THD:LUNit?, 5-62
- THD:MMAx, 5-62
- THD:MMAx?, 5-62
- THD:MMIN, 5-63
- THD:MMIN?, 5-63
- THD:NOTChfreq, 5-63
- THD:NOTChfreq?, 5-63
- THD:SET?, 5-63
- THD:SPEed, 5-64
- THD:SPEed?, 5-64
- THD:STEPs, 5-64
- THD:STEPs?, 5-64
- THD:SWPType, 5-64
- THD:SWPType?, 5-65
- THD:TUNe, 5-65
- THD:TUNe?, 5-65
- THD:UNIT, 5-65
- THD:UNIT?, 5-66
- THD:WTD, 5-66
- THD:WTD?, 5-66
- TIME?, 2-22
- TRIGger, 3-11
- TRIGger?, 3-11
- Triggered Measurements, 1-19
- units and unit prefixes, 1-8
- User Request, 1-10
- Verbose, 1-6
- VERBoSe, 2-23
- Verbose Query Responses, 1-6
- VERBoSe?, 2-23
- WAVeform, 4-4
- WAVeform?, 4-4
- WF:, 5-67
- WF:DETEctor, 5-67
- WF:DETEctor?, 5-67
- WF:FILTer, 5-67
- WF:FILTer?, 5-67
- WF:LUNit, 5-67
- WF:LUNit?, 5-68
- WF:MMAx, 5-68
- WF:MMAx?, 5-68
- WF:MMIN, 5-68
- WF:MMIN?, 5-68
- WF:RESPonse, 5-69
- WF:RESPonse?, 5-69
- WF:SET?, 5-69
- WF:UNIT, 5-69
- WF:UNIT?, 5-69
- WF:WFUNit, 5-70
- WF:WFUNit?, 5-70
- XTALk:, 5-71
- XTALk:AMAX, 5-71
- XTALk:AMAX?, 5-71
- XTALk:AMIN, 5-71
- XTALk:AMIN?, 5-72
- XTALk:EXternal, 5-72
- XTALk:EXternal?, 5-72
- XTALk:FMAX, 5-73
- XTALk:FMAX?, 5-73
- XTALk:FMIN, 5-73
- XTALk:FMIN?, 5-73
- XTALk:LUNit, 5-73
- XTALk:LUNit?, 5-74
- XTALk:MMAx, 5-74
- XTALk:MMAx?, 5-74
- XTALk:MMIN, 5-74
- XTALk:MMIN?, 5-74
- XTALk:SET?, 5-75
- XTALk:SPEed, 5-75
- XTALk:SPEed?, 5-75
- XTALk:STEPs, 5-75
- XTALk:STEPs?, 5-76
- XTALk:SWPType, 5-76
- XTALk:SWPType?, 5-76
- XTALk:UNIT, 5-76
- XTALk:UNIT?, 5-76
- ZINA, 5-4
- ZINA?, 5-5
- ZINB, 5-5
- ZINB?, 5-5



Audio Precision  
PO Box 2209  
Beaverton, Oregon 97075-2209  
Tel: (503) 627-0832 Fax: (503) 641-8906  
US Toll Free: 1-800-231-7350  
email: [techsupport@audioprecision.com](mailto:techsupport@audioprecision.com)  
Web: [www.audioprecision.com](http://www.audioprecision.com)